

DECOSAN

# Bath inspirations





Perché la bellezza,  
semplicemente è.

DECOSAN

Bath design







Concepiamo il bagno  
come lo spazio in cui  
una persona ritrova  
se stessa in modo intimo,  
naturale, senza filtri.

Intendiamo il bagno come  
possibilità di ricominciare ogni  
giorno, per riconoscersi e  
riprendere con nuove sfide  
e speranze.

Intendiamo il bagno con l'anima,  
dove il prodotto ha una vita  
propria e una perfetta armonia  
tra bellezza e funzionalità .

Intendiamo il bagno come lo spazio  
in cui la sua essenza contribuisce  
affinché la vita sia migliore.

DECOSAN

Bath design

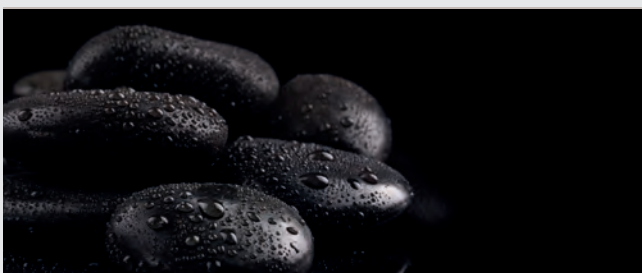

<b>00. Bath design</b>	<b>11</b>
La nostra essenza	12
Materiali con l'anima	16
I nostri materiali	18
R&S	20
I nostri concetti	22
Showroom Professionale	25
I nostri designer	26

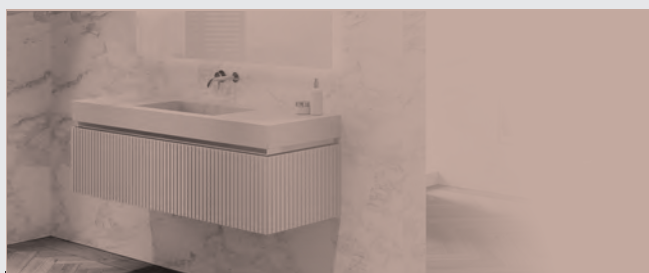

<b>01. Atelier</b>	<b>29</b>
<b>Arredo bagno</b>	
Olympia: Estetico.....	30 - Tecnico .....104
Diamond: Estetico.....	44 - Tecnico .....112
Best: Estetico.....	62 - Tecnico .....122
Queen: Estetico.....	80 - Tecnico .....132
Alma: Estetico.....	88 - Tecnico.....140
Accessori Atelier	148



<b>04. Specchi</b>	<b>294</b>
Liscio	300
Retroilluminazione	301
Retroilluminazione anteriore	304
Cornici in metallo	306
Cornici in legno	308
Armadi a specchio	309
Completa il tuo specchio	310

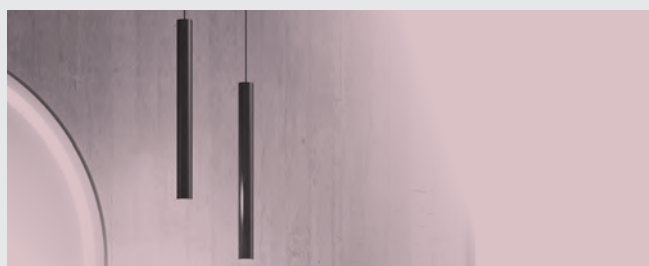

<b>05. Illuminazione</b>	<b>314</b>
Applique per specchi	318
Illuminazione decorativa	320





<b>02. Casual</b>	<b>155</b>
<b>Arredo bagno</b>	
Play: Estetico.....	156 - Tecnico .....230
Step: Estetico.....	214 - Tecnico .....252



<b>03. Piani Lavabo</b>	<b>258</b>
Integrato standard	262
Integrato su misura	268
Lavabo da appoggio	276
Totem	283
Piani lavabo	284
Accessori da appoggio	292

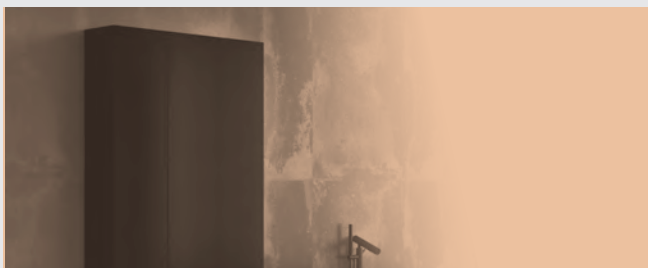

<b>06. Complementi</b>	<b>322</b>
Colonne	328
Armadi	330
Ripiani	332
Portasciugamani	334
Ausiliari Atelier	336

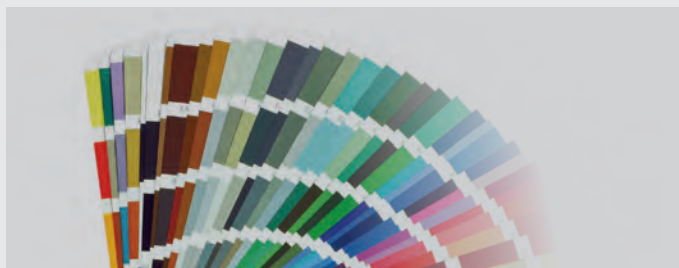

<b>07. Colori</b>	<b>340</b>
Condizioni di vendita	348
Manuale di installazione	349

La perfezione si ottiene, non quando  
non c'è più niente da aggiungere, ma  
quando non c'è più niente da togliere.

Antoine de Saint-Exupéry (1900-1944)  
Scrittore e poeta francese



# 00 Bath design

DECOSAN

Bath design



## La nostra essenza

---

Decosan, azienda specializzata nella produzione di mobili e accessori per il bagno, fa parte del gruppo aziendale Nofer.

Dopo 35 anni di esperienza, oggi abbiamo un tessuto industriale molto potente con uno stabilimento produttivo di 2200 m<sup>2</sup>, un ufficio centrale e uno showroom di 1200 m<sup>2</sup> e un centro logistico di oltre 3000 m<sup>2</sup> che ci permette di esportare in più di 70 paesi.

DECOSAN

Milano

DECOSAN

Mosca



DECOSAN

Barcellona

DECOSAN

Dubai



Industria 100% Made in Barcellona dove artigianato e tecnologia si fondono per creare soluzioni uniche con una particolare attenzione ai dettagli.









## Materiali con anima

---

Come produttori selezioniamo la materia prima con cui lavorare contribuendo con le nostre conoscenze artigiane alle quali uniamo la massima tecnologia industriale che abbiamo nel nostro stabilimento di produzione a Barcellona.

Rispettare il prodotto, trattarlo bene, ci permette di custodire l'essenza di ogni materia prima nel nostro prodotto finale.



# I nostri materiali



## Legno Nature

Finitura decorativa che viene applicata al pannello di particelle e che presenta molteplici colori e finiture con ottime prestazioni meccaniche e resistente a graffi, urti e abrasioni.

## Solid Surface (Cristalplant)

Solid Surface è un materiale di ultima generazione composto per due terzi di minerali naturali e resine a base BIO derivate dal mais. Il risultato è un materiale non poroso, antibatterico, setoso e caldo al tatto. La sua struttura e composizione lo rendono riparabile.

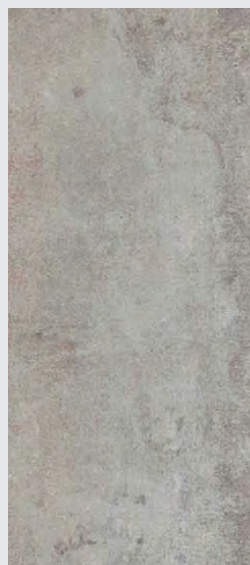
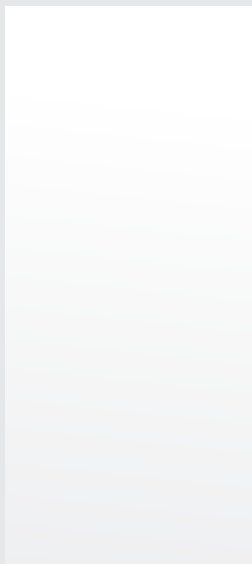

## Microcimento

Materiale decorativo composto di pigmenti cementizi e minerali per ottenere una finitura compatta, molto resistente e di facile pulizia.

## Legno Massello

Legno di rovere naturale al 100%. Il piano in rovere massello è fabbricato a doghe, cioè incollando strisce da 8 a 15 cm. Prodotto naturale di straordinaria bellezza che rispetta le irregolarità del tronco d'albero, è protetto con oli naturali che garantiscono una grande durata pur mantenendo il suo aspetto naturale.

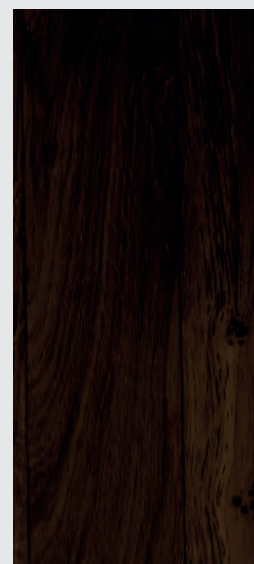

## Pannello Multistrato Marino

Tavola multistrato di colle fenoliche con grande stabilità dimensionale e resistenza all'umidità. Impiallacciate rovere naturale, rovere rustico o noce a seconda della finitura desiderata. La finitura finale è ottenuta con oli naturali rispettando la texture con la massima protezione dagli agenti esterni.

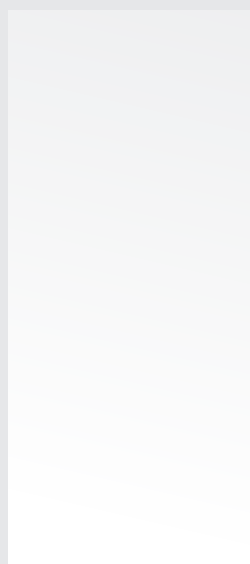

## Solid Mineral (Mineralsolid)

Materiale composto da cariche minerali naturali e resine ad alta resistenza. Si tratta di un materiale non poroso, antibatterico, leggero e al tatto molto setoso.

## Fibralac

Materiale che per la sua composizione e le caratteristiche di alta densità è ideale per ottenere finiture laccate opache e lucide. È costituito da fibre di legno pressate a secco con resine sintetiche che fungono da legante, offrendo una struttura compatta e molto liscia.



### Pietra Naturale

Roccia calcarea cristallizzata e compatta, 100% naturale estratta dalle cave. Una vasta gamma di colori è disponibile con un trattamento antimacchia con finitura opaca che ne impedisce l'assorbimento. È un prodotto naturale e irripetibile quindi i campioni di colore sono solo indicativi.



### Ceramica

Una pasta di sostanza argillosa dalla struttura compatta, modellata e sottoposta a diversi processi di cottura che garantiscono la vetrificazione della superficie, che le conferisce prestazioni straordinarie. Meccanico, igienico e manutenzione molto facile.

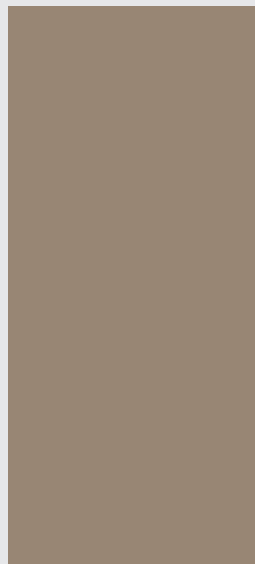

### Resina

Nuovo materiale sintetico ottima qualità e planimetria. Il suo colore bianco ceramica lo rende ideale per le nuove linee di arredo bagno. Al tatto è caldo, è facile da pulire e ha una lunga durata oltre ad essere resistente all'usura.

### Ceramcolor

Smalto colorato ad alte prestazioni a base di nanoparticelle con elevate proprietà antibatteriche, non poroso e con grande resistenza meccanica a macchie e ad agenti chimici. È applicabile su porcellana e pietra compatta.

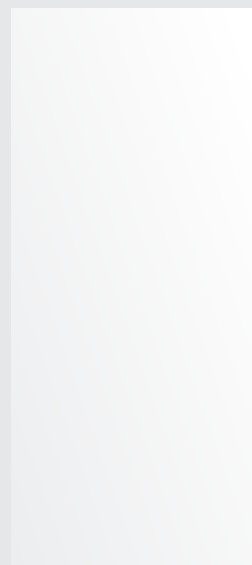

### Cristalcolor

Cristallo ottico completamente trasparente che si colora e vetrifica nel forno. I lavabi termoformati si producono in forni ad alte temperature creando un lavabo con una caduta progressiva e una tessitura mate e setosa al tatto.

### Vetro Bianco

Cristallo colorato con pasta bianca generando un cristallo bianco opaco in finitura lucida.



### Metal Inox

L'acciaio inossidabile è un acciaio d'alta lega che contiene cromo e altri leganti che gli conferiscono una caratteristica di grande resistenza alla corrosione. I prodotti in acciaio inossidabile sono sottoposti a trattamenti superficiali lucido o satinati ma possono essere anche rivestiti di colori per ottenere altre finiture.



I nostri materiali

## R&S

# Ricerca, Sviluppo e Innovazione

---

Trattamento dei materiali e massimo coinvolgimento nello sviluppo di nuovi prodotti e sistemi ci permettono di offrire proposte innovative con una propria identità.

Il nostro impegno per il continuo perfezionamento ci ha permesso di implementare nuovi sistemi e tecnologie che migliorano la qualità di utilizzo e il comfort di ogni prodotto.





# I nostri concetti



## SU MISURA

Questa collezione consente la produzione personalizzata. In caso di misure intermedie in altezza e larghezza prendere il prezzo della misura immediatamente più alta.



## FULLCOLOR ANTRACITE

Idea di design d'interni per cui tutti i materiali degli interni dei mobili sono progettati in colore antracite. Il mobile con finitura laccata è internamente laccato antracite.



## ATELIER SYSTEM

Nelle finiture tavola marina o massello, i pezzi sono selezionati in modo numerato per rispettare la continuità delle venature in tutto il mobile.

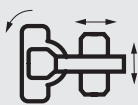

## CERNIERE BLUM 3D

Le cerniere sono regolabili in altezza, profondità e inclinazione per una vestibilità perfetta.



## CASSETTI 4D

Cassetti in metallo Hettich o Blum colore antracite con profilo extra-sottile da 12 mm con 4 regolazioni. Le guide sono ad estrazione totale e impianto frenante progressivo.



## DECOBUILD SYSTEM

Mobili realizzati con tavole da 19 mm incollate insieme ottenendo un'estetica pulita senza inserti visibili, offre una migliore resistenza e durevolezza.



## DECOFIX SYSTEM

Sistema di fissaggio a muro ad alta sicurezza con il quale le resistenze al carico sono maggiori di 240 kg.



## DECOSPACE SYSTEM

Sistema che prevede la fornitura di un sifone salvaspazio e di una valvola click clack cromata lucida. Questa soluzione evita l'inscatolamento del cassetto superiore, migliorando la capacità di contenimento e l'estetica degli interni poiché le strutture sono nascoste.



## DURALACK SYSTEM

I colori laccati contengono additivi indurenti che permettono alla finitura finale di essere altamente resistente allo sfregamento e all'abrasione.



## RIPIANI INTERNI CRISTALLO

I ripiani interni in vetro hanno uno spessore di 6 mm. Nel caso di vetrine e pensili, i ripiani sono grigio fumé.



## SPECCHIO INGRANDENTE MOBILE

È possibile dotare lo specchio di uno specchio magnetizzato x3 che consente il posizionamento nella zona destra dello specchio e regolarne la posizione in altezza o riporlo nel mobile.



## SPECCHIO INGRANDENTEX5 LED

Puoi personalizzare il tuo specchio con uno specchio ingrandente x5 con LED integrato.



#### SPECCHIO ANTI APPANNAMENTO

È possibile dotare lo specchio di un sistema anti appannamento. Una lamina termica aderisce alla parte posteriore dello specchio e eviterà la condensa dell'acqua sullo specchio, migliorando il comfort di utilizzo e il perfetto riflesso dei quest'ultimo.



#### SPECCHI CON BLUETOOTH

Puoi collegare il tuo cellulare allo specchio tramite bluetooth e goderti la tua musica in bagno.



#### SPECCHI CON LUCE FREDDA E / O CALDA

Puoi personalizzare il tuo specchio con la temperatura del colore che desideri, più calda o più fredda, da 2700°k a 5500°K. Puoi persino dotare il tuo specchio di un sensore tattile che ti permetterà di modificare la temperatura del colore, che sia caldo, neutro o freddo.



#### SPECCHI CON SENSORE ACCESO SPENTO

Questa opzione ti consentirà di accendere / spegnere lo specchio e modificare l'intensità della luce se necessario con una leggera pressione sul sensore tattile.



#### PUSH AND SLOW

I cassetti con il sistema di apertura senza maniglie "Push" hanno un sistema di sincronizzazione che permette loro di essere aperti premendo in qualsiasi punto del frontale. Allo stesso tempo, la chiusura è progressiva e silenziosa.



#### PORTE A SPINTA SENZA TIRATORE

Le ante delle colonne e degli armadi hanno il sistema di espulsione push che può essere utilizzato anche solo come fermo.



#### SENSORE ANTIAPPANNAMENTO

Sensore ON/OFF per trattamento antiappannamento.



#### SISTEMA DI SICUREZZA PENSILE CARICA 150 KG

Le colonne e gli armadi hanno un sistema di sospensione di sicurezza con una capacità di carico di 150 Kg.



#### SISTEMA DI SCHERMO CON SENSORE ON / OFF

La tecnologia ci consente di replicare lo schermo del tuo cellulare allo specchio. Con questo, puoi riprodurre facilmente tutti i contenuti del tuo cellulare, come video e foto, allo specchio. Compatibile con IOS e Android.



#### WOOD PROTECT SYSTEM

I legni massello o di tavola marina sono protetti dagli agenti esterni con oli naturali che rispettano la consistenza e la natura del legno.



I nostri concetti



Prodotto a Barcellona

Uno spazio per condividere  
esperienze sito nel  
cuore di Barcellona, città di  
design e ispirazione.





## Showroom Professionale

---

Workshop, tavole rotonde, seminari e attività diverse per essere vicini al professionista con cui costruire il futuro del interior design del bagno.

Alla nostra esperienza nel trattamento dei materiali e la nostra offerta di prodotti, combiniamo il modo di concepire il progetto dall'idea iniziale, come partner per personalizzare ogni progetto, dalla sua ideazione e durante il suo sviluppo, apportando il nostro valore in ogni bagno.

Lasciati ispirare. Lasciati ispirare. Lasciati guidare in uno spazio con un'anima, immagina il bagno dei tuoi sogni, ti invitiamo a toccarlo, sentirlo e farlo tuo.



# I nostri designers

---

I progettisti lavorano secondo un processo di progettazione che inizia con l'interpretazione o il rilevamento di un problema o di una necessità e culmina con la produzione o la costruzione della soluzione a questo problema.



## *CirculoCuadrado*

CirculoCuadrado e' lo Studio di interior design fondato da Ismael Barajas e Maribel Caballero laureati in Interior Design a Barcellona.

Dopo un lungo percorso professionale individuale, inaugurano il loro studio in comune nel 2006. Si definiscono con uno stile minimalista, in costante ricerca dell'ordine visivo e dell'applicazione di materiali nobili.

**CIRCULO<sup>®</sup>  
CUADRADO**

## *Decosan Studio*

Il nostro team sviluppa progetti e concetti con una visione globale. Materiali, tecnologia, forma, ergonomia, linguaggio, comunicazione visiva e creatività sono elementi che consideriamo in tutti i progetti per ottenere il prodotto ideale.





# 01 Atelier Arredo bagno

Cura dei dettagli, lavorazione artigianale  
sotto forma di stile.

# Olympia

Lo stile che non ha mai  
smesso di essere tale.





▲ Vasca  
*Orion Solid Surface*



Luce decorativa  
*Ledpoint*



Complemento  
*Porta asciugamani da parete*







Mobile  
1 cassetto / finitura fregio laccato / collo in Acero Cepillado

 108

Specchio retroilluminato  
Spined

 303



▲ Mobile sospeso alto 35 cm



Beige



Perla



Acero



Piedra



Tierra



Caqui



Albero



Moka



Antracita

- ▲ Personalizza il colore dei tuoi mobili con 18 colori standard o dalla tabella RAL/NCS

Vasca

▼ Borealis Solid Surface

Mobile

1 cassettone + cassetto interno /  
fregio finitura Noce / gola in Oro Cepillado





▼ Piano con lavabo integrato Plus in Pietra Naturale Negro Marquina



▼ Armadio altezza 54 con un cassetto 1 vano



▼ Struttura del mobile squadrata in Pannello Multistrato Marino



▲ Sistema Decospace. Cassetto superiore senza ritaglio. Valvola e sifone salvaspazio inclusi

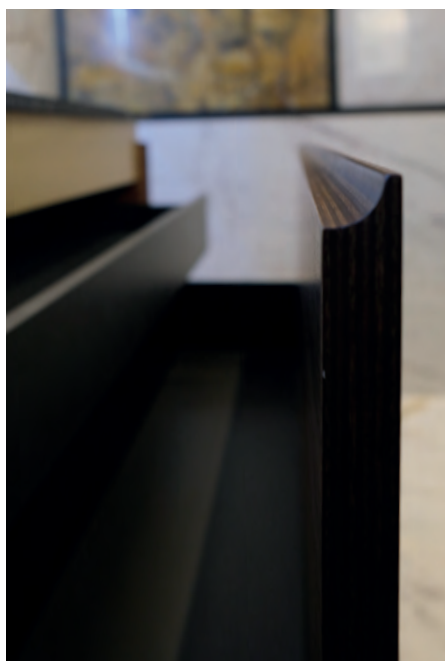

▲ Cassetti extra slim 4D con sistema di estrazione totale e chiusura silenziosa



▲ Complemento  
*Pensile porta vetro fumé e profilo  
vetrina in metallo nero opaco*





**Mobile**

*1 cassetto / finitura rovere  
rustico liscio / collo laccato  
Negro opaco*



**Piano lavabo**

*Piano lavabo in Pannello Multistrato  
Marino Legno Rústico  
Lavabo da appoggio in acciaio inox*



OLYMPIA

**Specchio retroilluminato**

*Circled*





◀ Personalizza i tuoi mobili Olympia con una texture di fregio liscio



OLYMPIA

▼ Fregio texture



▲ Liscio al tatto

Personalizza il manico dei mobili con finiture metalliche, laccate in qualsiasi colore o in legno naturale in 8 diversi colori.



# Diamond

Il taglio rende il diamante  
un gioiello.

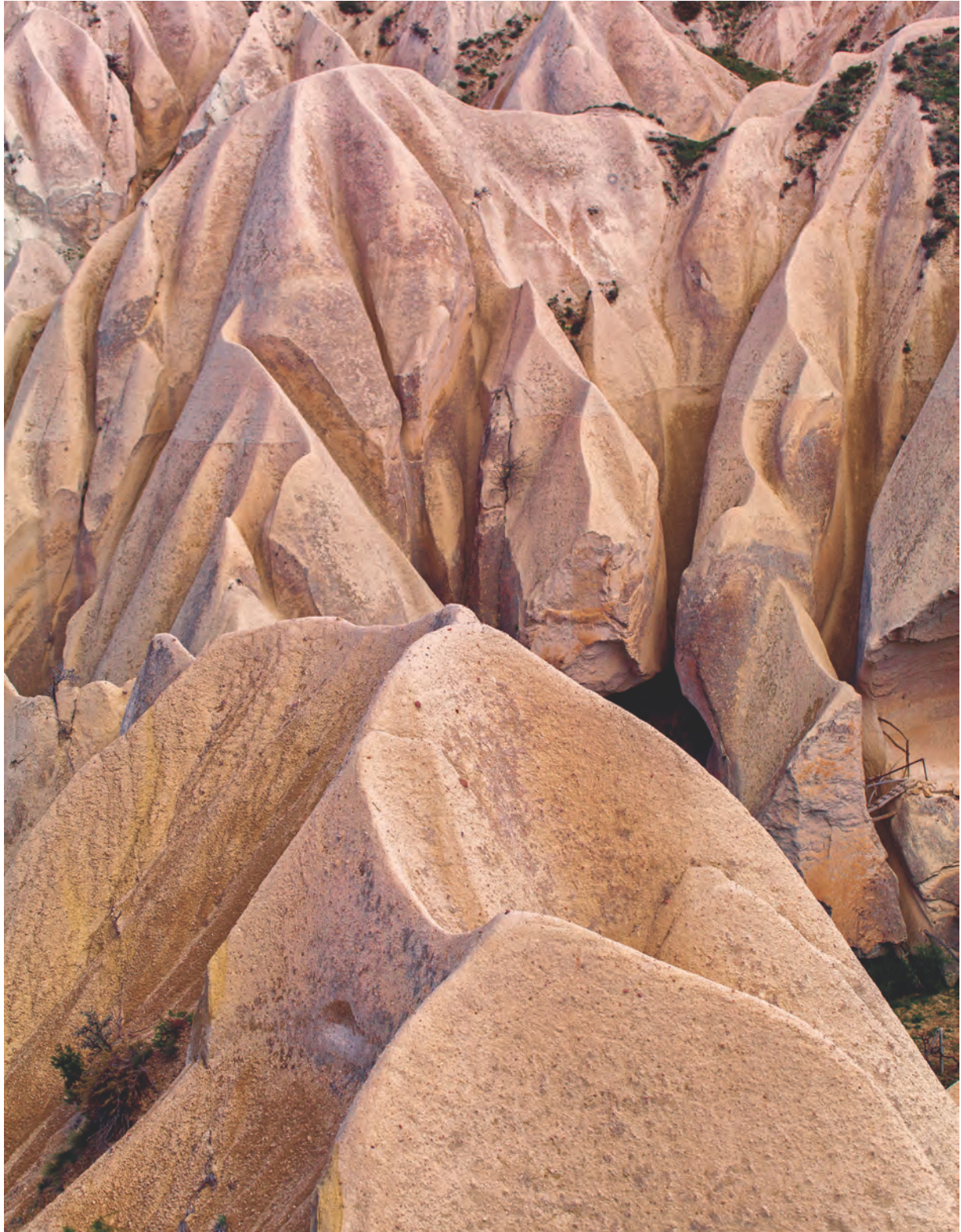



116

**Mobile ▶**

*Composto da 3 cassette e 2 nicchie decorative / finitura Noce e Negro  
Opaco maniglia Inglete Diamond*



274

**Piano lavabo integrato**  
*Cristalcolor Negro*



338

**Bagno**  
*Andrómeda Solid Surface*



320

**Luce decorativa**  
*Ledarc*











◀ Specchio retroilluminato  
*Spinled con specchio ingranditore mobile*

Complemento  
*Mensola decorativa con divisorio interno mobile*

Luce decorativa  
*Ledarc nero opaco*

▼ Design atelier  
*Venatura del legno continua per tutta  
la lunghezza del mobile*





119

Mobile ▶  
*2 cassettoni / finitura laccata /  
maniglia Push*



274

Piano lavabo  
*in Cristalcolor integrato*



303

Specchio retroilluminato  
*Spinled*



320

Luce decorativa  
*Ledarc*







- ▲ Piano lavabo integrato in vetro ottico con texture opaca e personalizzabile con qualsiasi colore della cartella RAL

▼ Lati obliqui effetto  
diamante



▼ Dettaglio effetto diamantato esterno  
smussamento perimetrale

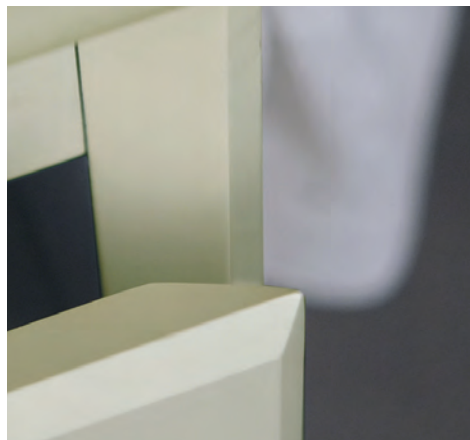

▲ Dettaglio del diamante interno  
smussato



Mobile  
2 cassetti / finitura Pannello Multistrato  
Marino / maniglia Diamond



Piano lavabo  
Parte superiore piana, Solid Surface  
Lavabo da appoggio in Solid Surface





Specchio  
*Specchio Retroled*  
*Specchio ingranditore mobile*



Luce decorativa  
*Ledcirc*



Bagno  
*Orion Solid Surface*



Mobile Ausiliario  
*Pannello Multistrato Marino*  
*doppia porta*





◀ Venatura continua, nel rispetto della maglia del legno

▶ Dettaglio della maniglia Diamond. Doppio bisello interno ed esterno che riproduce le dimensioni di un diamante







▲ **Mobile**  
*Composizione decorativa ad angolo con piano  
in Pietra Naturale e 1 cassettera  
con piano laccato*

 272

 116

**Specchi con cornice**  
*Metallo nero*

 306-307



Specchio  
*Spogliatoio 2 porte*



Luce decorativa  
*Ledcirc*





◀ Armadietto a specchio con ante asimmetrico con lati specchiati e maglia nascosta



◀ Modulo aggiuntivo con piano lavabo laccato



▲ Piano lavabo  
sospeso con lavabo  
integrato in Pietra Naturale

Specchio  
Specchi Metalround  
e Metalroundled

Luce decorativa  
Ledcirc



DIAMOND

# Best

Architettura pura,  
fusione di elementi.











◀ Personalizzazione led.  
Specchio Roundled con led  
perimetrale personalizzabile  
nella temperatura e nel colore

◀ Integrazione del colore.  
Lavabo in ceramica colorata.  
Piano Ceramcolor.  
Mobili laccati.  
Diversi elementi e  
materiali con lo stesso colore

▼ Maniglia e struttura a 45° mitra



Mobili Ausiliari ▶

*Composizione delle colonne  
anta decorativa e in legno  
con doppio ripiano.  
Rovere Legno Rústico*





▲ Mobile  
2 cassettoni e 1 cassetto interno  
/ maniglia Push / rovere finitura  
Legno Rústico

Piano lavabo integrato  
Solid Mineral

Specchio con illuminazione  
frontale  
Duoled

Luce decorativa  
Ledcirc



▲ Piano lavabo Regata integrato in finitura Pizarra naturale

Mensola in metallo con ▶  
ripiano in doppia tavola  
con Pannello Multistrato Marino rovere  
Legno Rústico



▼ Dettaglio maniglia  
struttura ad angolo a 45°



▼ Cassetti in metallo 4D con estrazione  
totale e chiusura silenziosa



► Dettaglio maniglia ad angolo





127

**Mobile ▶**

*2 cassetti / maniglia  
Inglete / finitura laccata*



291

**Piano lavabo**  
*Pietra naturale piatta  
Lavelli da appoggio*



306

**Specchio con  
illuminazione frontale**  
*Metalroundled*



321

**Luce decorativa**  
*Ledcirc*









▲ Materiali e colori.  
Equilibrio estetico



◀ Luce decorativa  
*Ledpoint*



◀ Mobile Ausiliario  
*Scaffalatura metallica  
con doppio ripiano  
laccato*



▲ Mobile  
*Mobile contenitore ausiliario con  
base superiore in Solid Mineral*



130

Specchio  
*Corner*



308

Scaffale Ausiliario  
*Scaffale decorativo*



333



**Mobile**  
1 cassettone + 2 cassetti /  
maniglia Push / finitura Pannello  
Multistrato Marino



**Piano lavabo**  
Solid Mineral piatto. Lavabo ad angolo  
Hug in Solid Mineral con ripiano  
laterale decorativo



**Specchio**  
Triled con sistema Screen



▼ Specialisti in Solid Surface. Vasche da bagno, piani lavabo, lavandini



▲ Architettura di Solid Surface. Progetti personalizzati



BEST



# Queen

Stile unico e distinto.





308

Specchio con cornice  
*Luxor argento*

291

Parte superiore piatta  
*Pietra Naturale Carrara*

136

Mobile  
*1 cassetto / maniglia  
Queen / finitura laccata*





137

Mobile

4 cassetti / maniglia Queen /  
finitura laccata



272

Piano lavabo integrato

Pietra Naturale Carrara  
con doppio lavabo



308

Specchio con cornice

Luxor argento





◀ Mobile

1 cassetto / maniglia Queen /  
finitura laccata

Specchio con cornice  
Luxor oro

Dettaglio

▼ Cassetto e spigoli oro



Dettaglio

▼ Cassetto e spigolo cromo





◀ Mobile  
*Laccato Bianco*



◀ Mobile  
*Lacca Océano*



◀ Mobile  
*Lacca Negro*



◀ Mobile  
*Lacca Burdeos*

Mobile ▶  
*4 cassetti / Queen pull /  
finitura laccata*

Specchio con cornice  
*Luxor oro*



QUEEN



# Alma by CIRCULO<sup>®</sup> CUADRADO

L'essenza della materia  
prima. Rispetta e coccola  
il prodotto.







◀ Mobile

*Panca 2 cassetti / maniglia Push / finitura  
rovere massello sul frontale e laccata sui lati*

 146

Piano lavabo

*parete piana in massello di rovere*

 287

Specchio

*Round Liscio, struttura metallica*

 300

Vasca

*Leo Solid Surface*

 338



▲ Assistente

*Portasciugamani Lean, in rovere massello*

 337

Lavabo ►  
Solid Surface Eliptic,  
extrafino



Contro soffitto ►  
mitra in rovere  
massello finito per  
rispettare il natura  
del legno





Piano in rovere massello  
misura sospesa



- ▲ Complementi d'arredo  
*Banco in struttura metallica con parte superiore in rovere massello*

 335



Lavabo  
*Totem Solid Surface*



Piano lavabo  
*Piano Solid Surface  
bianco mate*



Mobile  
*2 cassetti / tirante Push / lateral slim  
bianco mate e frontale in rovere massello  
in finitura Legno*



Luce decorativa  
*Ledcirc*





▲ Totem in Solid Surface





▲ Dettaglio laterale laccato metallo extra fine

## CIRCULO<sup>®</sup> CUADRADO



145

Mobile ▶

2 cassetti / maniglia Push /  
finitura laccata



270

Piano lavabo Integrato  
Solid Surface



287

Piano lavabo piatto  
Piano lavabo finitura laccata



300

Specchio liscio  
A misura



321

Luce decorativa  
Ledcirc



336

Complementi d'arredo  
Pensili by CirculoCuadrado  
finitura laccata













CIRCULO  
CUADRADO

◀ Complementi d'arredo  
*Set di cassettiere by  
CirculoCuadrado  
finitura laccata*

Complementi d'arredo ▶  
*Pensili by  
CirculoCuadrado  
finitura laccata*



	NCSS 7500-N
	NCSS 1002-Y
	NCSS 5010-G70Y
	NCSS 5010-B10G
	NCSS 4030-Y80R
	NCSS 4010-Y90R

▲ Colori  
*Colori suggeriti da  
CirculoCuadrado  
finitura laccata, mate  
o lucida*



ALMA



# 01

## Informazioni tecniche e prezzi

# Atelier

DECOSAN

Bath design





# Olympia

Caratteristiche e attrezzature	106
Personalizza i tuoi mobili Olympia	107
Basi lavabo sospese	108
Moduli sospesi	110
Accessori Atelier	148



### SISTEMA DECOSPACE

Sistema che prevede la fornitura di un sifone salva spazio e di una valvola click clack cromata lucida. Questa soluzione evita il cedimento del cassetto superiore migliora la capacità di stoccaggio e l'estetica degli interni poiché le strutture sono nascoste.



### CASSETTI 4D

Cassetti Hettich o Blum in metallo colore antracite e con profilo extra sottile da 12 mm con 4 regolazioni. Le guide sono ad estrazione totale e impianto frenante progressivo.



### SU MISURA

Questa collezione consente la produzione personalizzata. Nel caso di misure intermedie di altezza e larghezza, prendere il prezzo della misura immediatamente superiore.



### ANTRACITE PIENO DI COLORI

Concetto di interior design in cui tutti i materiali all'interno dei mobili sono progettati in antracite. Il mobile con finitura laccata è internamente laccato antracite.



### SISTEMA DURALACK

I colori laccati contengono additivi indurenti che permettono alla finitura finale di essere altamente resistente allo sfregamento e all'abrasione.



### SISTEMA DECOFIX

Sistema di fissaggio a muro ad alta sicurezza con il quale le resistenze al carico sono maggiori di 240 kg.



### SISTEMA DECOBUILD

Mobili realizzati con tavole da 19 mm incollato insieme con mannaie ottenendo un'estetica pulita senza raccordi visibili e offrendo una migliore resistenza e durata.



### LEGNO PROTEGGI SISTEMA

Il legno di tavola marina è protetta dagli agenti esterni con oli naturali che rispettano la consistenza e la natura del legno.



### SISTEMA ATELIER

Nelle finiture del bordo marino, i pezzi sono selezionati in modo numerato per rispettare la continuità delle venature in tutto il mobile

## Configura e personalizza i tuoi mobili Olympia

### A Scegli la struttura

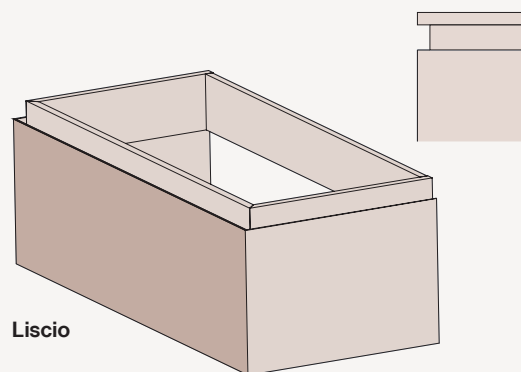
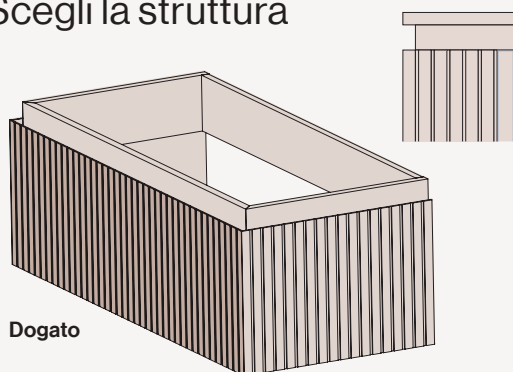

### B Colori disponibili per il mobile

#### Laccato



#### Pannello Multistrato Marino / Impiallacciato Rovere e Noce

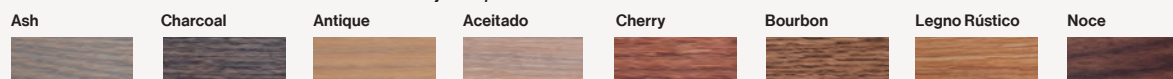

### C Colori disponibili per la gola



#### Pannello Multistrato Marino / Impiallacciato Rovere e Noce

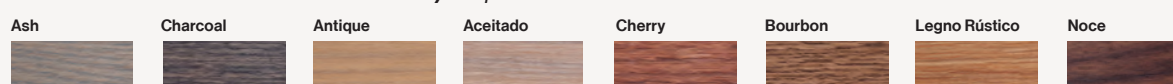

#### Metallo



### BASI PER LAVABO SOSPESO

#### 1 CASSETTO

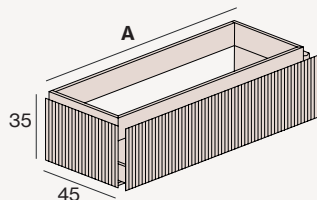

A (cm)	LAVABO	COD	LACCA		PANNELLO MULTISTRATO MARINO	
			FRONTALE DOGATO	FRONTALE LISCIO	FRONTALE DOGATO	FRONTALE LISCIO
60		Y101.060.C	-	-	-	-
70		Y101.070.C	-	-	-	-
80		Y101.080.C	-	-	-	-
90		Y101.090.C	-	-	-	-
100		Y101.100.I	-	-	-	-
100		Y101.100.C	-	-	-	-
100		Y101.100.D	-	-	-	-
120		Y101.120.I	-	-	-	-
120		Y101.120.C	-	-	-	-
120		Y101.120.D	-	-	-	-
120		Y101.120.X	-	-	-	-
140		Y101.140.I	-	-	-	-
140		Y101.140.C	-	-	-	-
140		Y101.140.D	-	-	-	-
140		Y101.140.X	-	-	-	-

#### 2 CASSETTIASIMMETRICI

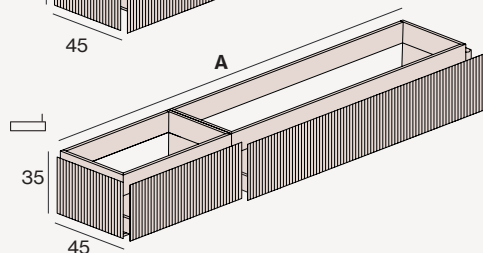
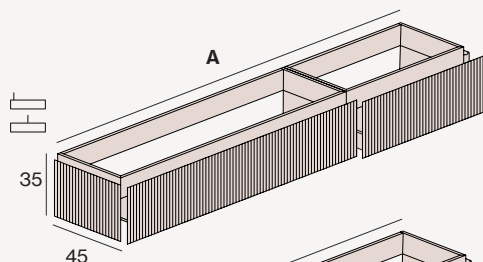

120		Y102.120.I	-	-	-	-
120		Y102.120.C	-	-	-	-
120		Y102.120.D	-	-	-	-
140		Y102.140.I	-	-	-	-
140		Y102.140.C	-	-	-	-
140		Y102.140.D	-	-	-	-
160		Y102.160.I	-	-	-	-
160		Y102.160.C	-	-	-	-
160		Y102.160.D	-	-	-	-
180		Y102.180.I	-	-	-	-
180		Y102.180.C	-	-	-	-
180		Y102.180.D	-	-	-	-
200		Y102.200.I	-	-	-	-
200		Y102.200.C	-	-	-	-
200		Y102.200.D	-	-	-	-

#### 2 CASSETTIASIMMETRICI

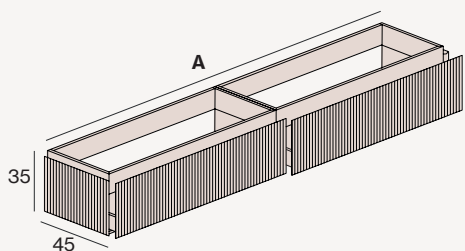

120		Y103.120.I	-	-	-	-
120		Y103.120.D	-	-	-	-
120		Y103.120.X	-	-	-	-
140		Y103.140.I	-	-	-	-
140		Y103.140.D	-	-	-	-
140		Y103.140.X	-	-	-	-
160		Y103.160.I	-	-	-	-
160		Y103.160.D	-	-	-	-
160		Y103.160.X	-	-	-	-
180		Y103.180.I	-	-	-	-
180		Y103.180.D	-	-	-	-
180		Y103.180.X	-	-	-	-
200		Y103.200.I	-	-	-	-
200		Y103.200.D	-	-	-	-
200		Y103.200.X	-	-	-	-



- Le composizioni asimmetriche hanno la seguente modulazione: 120 (80+40), 140 (100+40), 160 (100+60), 180 (120+60), 200 (120+80). Altre configurazioni disponibili.
- Mobili speciali: per misure intermedie in larghezza e / o altezza, prendere il prezzo della misura successiva più alta. Sfondo speciale disponibile da 39 a 45 cm. Consulta altri fondi.
- L'armadio altezza 35 non dispone del sistema Decospace. Se l'installazione lo consente, può essere ordinato senza sovrapprezzo.

- C Lavabo centrato
- D Lavabo destro
- I Lavabo sinistro
- X Doppio lavabo

### BASI PER LAVABO SOSPESO

#### CASSETTONE

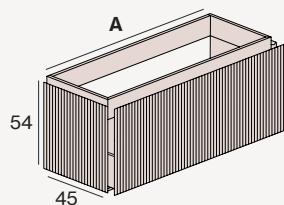

(1)

A (cm)	LAVABO	COD	LACCA		PANNELLO MULTISTRATO MARINO	
			FRONTALE DOGATO	FRONTALE LISCIO	FRONTALE DOGATO	FRONTALE LISCIO
60		Y202.060.C	-	-	-	-
70		Y202.070.C	-	-	-	-
80		Y202.080.C	-	-	-	-
90		Y202.090.C	-	-	-	-
100		Y202.100.I	-	-	-	-
100		Y202.100.C	-	-	-	-
100		Y202.100.D	-	-	-	-
120		Y202.120.I	-	-	-	-
120		Y202.120.C	-	-	-	-
120		Y202.120.D	-	-	-	-
120		Y202.120.X	-	-	-	-
140		Y202.140.I	-	-	-	-
140		Y202.140.C	-	-	-	-
140		Y202.140.D	-	-	-	-
140		Y202.140.X	-	-	-	-

#### 2 CASSETTONI ASIMMETRICI

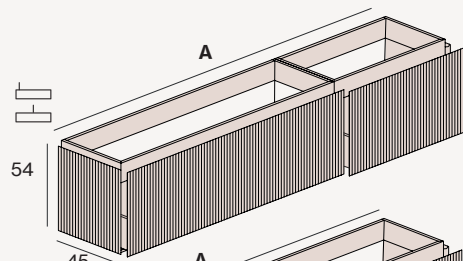

(1)

120		Y210.120.I	-	-	-	-
120		Y210.120.C	-	-	-	-
120		Y210.120.D	-	-	-	-
140		Y210.140.I	-	-	-	-
140		Y210.140.C	-	-	-	-
140		Y210.140.D	-	-	-	-
160		Y210.160.I	-	-	-	-
160		Y210.160.C	-	-	-	-
160		Y210.160.D	-	-	-	-
180		Y210.180.I	-	-	-	-
180		Y210.180.C	-	-	-	-
180		Y210.180.D	-	-	-	-
200		Y210.200.I	-	-	-	-
200		Y210.200.C	-	-	-	-
200		Y210.200.D	-	-	-	-

#### 2 CASSETTONI SIMMETRICI

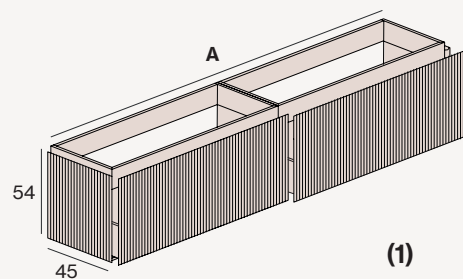

(1)

120		Y211.120.I	-	-	-	-
120		Y211.120.D	-	-	-	-
120		Y211.120.X	-	-	-	-
140		Y211.140.I	-	-	-	-
140		Y211.140.D	-	-	-	-
140		Y211.140.X	-	-	-	-
160		Y211.160.I	-	-	-	-
160		Y211.160.D	-	-	-	-
160		Y211.160.X	-	-	-	-
180		Y211.180.I	-	-	-	-
180		Y211.180.D	-	-	-	-
180		Y211.180.X	-	-	-	-
200		Y211.200.I	-	-	-	-
200		Y211.200.D	-	-	-	-
200		Y211.200.X	-	-	-	-

#### Accessori

##### & complementa

COMPLETA  
IL TUO MOBILE  
Organizzatori,  
portasciugamani,...  
pagina 148

#### (1) CASSETTO INTERNO

Il cassetto interno  
si puo' mettere  
nelle composizioni  
con cassettone.

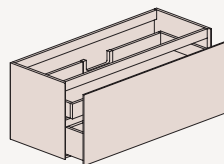

A (cm)	COD	PVP
40	A220.040	-
60	A220.060	-
70	A220.070	-
80	A220.080	-
90	A220.090	-
100	A220.100	-
120	A220.120	-
120X	A220.120X	-
140	A220.140	-
140X	A220.140X	-

## MODULI SOSPESI

## 1 CASSETTO

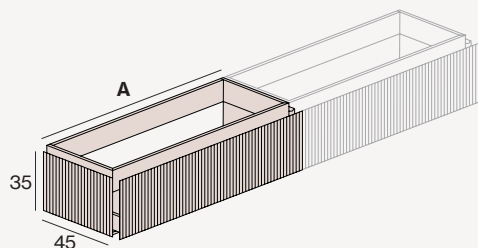

A (cm)	COD	LACCA		PANNELLO MULTISTRATO MARINO	
		FRONTALE DOGATO	FRONTALE LISCIO	FRONTALE DOGATO	FRONTALE LISCIO
30	Y101.030.M	-	-	-	-
40	Y101.040.M	-	-	-	-
60	Y101.060.M	-	-	-	-
70	Y101.070.M	-	-	-	-
80	Y101.080.M	-	-	-	-
90	Y101.090.M	-	-	-	-
100	Y101.100.M	-	-	-	-
120	Y101.120.M	-	-	-	-
140	Y101.140.M	-	-	-	-

## 2 CASSETTI

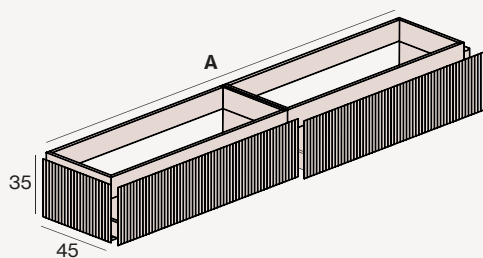

120	Y103.120.M	-	-	-	-
140	Y103.140.M	-	-	-	-
160	Y103.160.M	-	-	-	-
180	Y103.180.M	-	-	-	-
200	Y103.200.M	-	-	-	-



· E' possibile creare il proprio mobile personalizzandolo, aggiungendo i moduli a destra e/o sinistra alla base del lavabo selezionato, specificando la posizione degli stessi

## MODULI SOSPESI

## 1 CASSETTONE

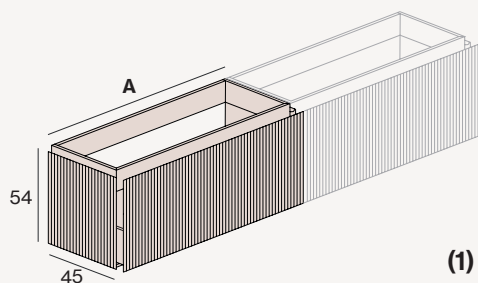

A (cm)	COD	LACCA		PANNELLO MULTISTRATO MARINO	
		FRONTALE DOGATO	FRONTALE LISCIO	FRONTALE DOGATO	FRONTALE LISCIO
30	Y202.030.M	-	-	-	-
40	Y202.040.M	-	-	-	-
60	Y202.060.M	-	-	-	-
70	Y202.070.M	-	-	-	-
80	Y202.080.M	-	-	-	-
90	Y202.090.M	-	-	-	-
100	Y202.100.M	-	-	-	-
120	Y202.120.M	-	-	-	-
140	Y202.140.M	-	-	-	-

## Accessori

**& complementa**

COMPLETA  
IL TUO MOBILE  
Organizzatori,  
portasciugamani,...  
pagina 148

**(1) CASSETTO INTERNO**

Il cassetto interno  
si puo' mettere  
nelle composizioni  
con cassetto.

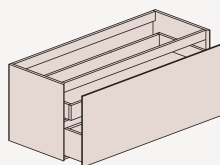

A (cm)	COD	PVP
40	A221.040	-
60	A221.060	-
70	A221.070	-
80	A221.080	-
90	A221.090	-
100	A221.100	-
120	A221.120	-
140	A221.140	-





# Diamond

Caratteristiche e attrezzature	114
Personalizza i tuoi mobili Diamond	115
Basi lavabo sospese	116
Moduli sospesi	120
Accessori Atelier	148



### DECOSPACE SYSTEM

Sistema che prevede la fornitura di un sifone salva spazio e di una valvola click clack cromata lucida. Questa soluzione evita il cedimento del cassetto superiore migliora la capacità di stoccaggio e l'estetica degli interni poiché le strutture sono nascoste.



### CASSETTI 4D

Cassetti Hettich o Blum in metallo colore antracite e con profilo extra sottile da 12 mm con 4 regolazioni. Le guide sono ad estrazione totale e impianto frenante progressivo.



### SU MISURA

Questa collezione consente la produzione personalizzata. Nel caso di misure intermedie di altezza e larghezza, prendere il prezzo della misura immediatamente superiore.



### ANTRACITE PIENO DI COLORI

Concetto di interior design in cui tutti i materiali all'interno dei mobili sono progettati in antracite. Il mobile con finitura laccata è internamente laccato antracite.



### DURALACK SYSTEM

I colori laccati contengono additivi indurenti che permettono alla finitura finale di essere altamente resistente allo sfregamento e all'abrasione.



### PUSH AND SLOW

I cassetti con sistema di apertura senza maniglie Push hanno un sistema di sincronizzazione che permette di aprirli premendo in un punto qualsiasi del frontale. Allo stesso tempo, la chiusura è progressiva e silenziosa.



### DECOFIX SYSTEM

Sistema di fissaggio a muro ad alta sicurezza con il quale le resistenze al carico sono maggiori di 240 kg.



### DECOBUILD SYSTEM

Mobili realizzati con tavole da 19 mm incollate insieme con mannaie ottenendo un'estetica pulita senza raccordi visibili e offrendo una migliore resistenza e durata.



### WOOD PROTECT SYSTEM

Il legno di tavola marina è protetto dagli agenti esterni con oli naturali che rispettano la consistenza e la natura del legno.



### ATELIER SYSTEM

Nelle finiture del bordo marino, i pezzi sono selezionati in modo numerato per rispettare la continuità delle venature in tutto il mobile

## Configura e personalizza i tuoi mobili Diamond

### A Scegli la maniglia

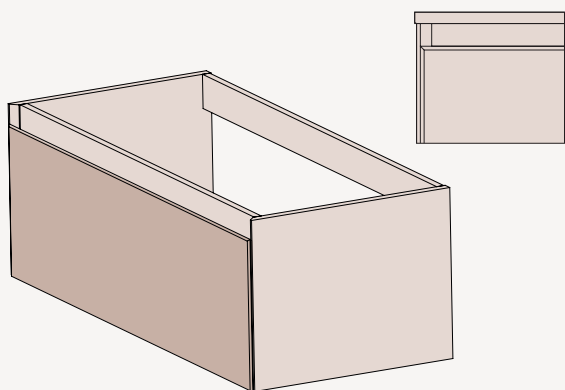

Diamond

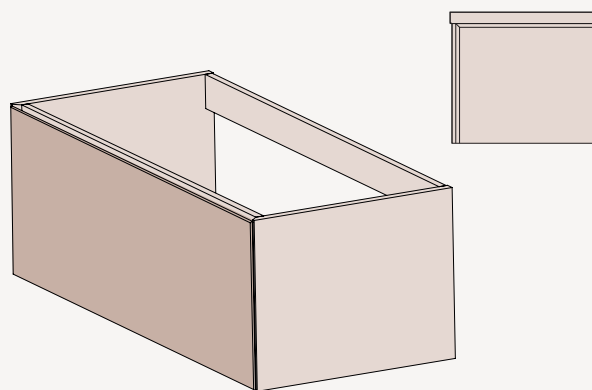

Push

### B Scegli il colore

#### Laccato



#### Pannello Multistrato Marino / Impiallacciato Rovere e Noce

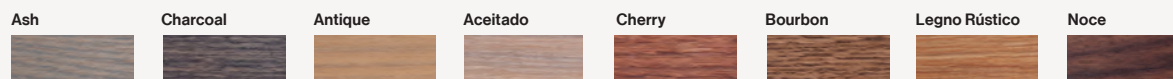

## BASI PER LAVABO SOSPESO

## 1 CASSETTO

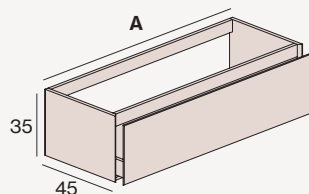

## 2 CASSETTIASIMMETRICI

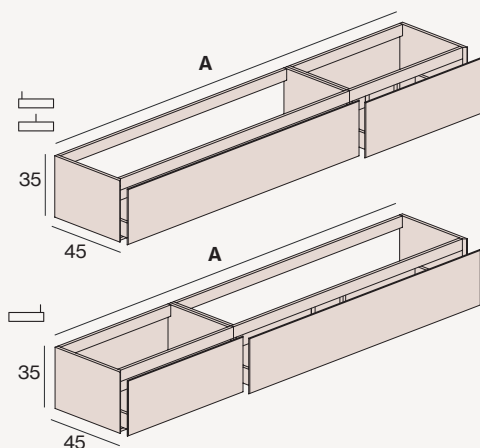

## 2 CASSETTISIMMETRICI

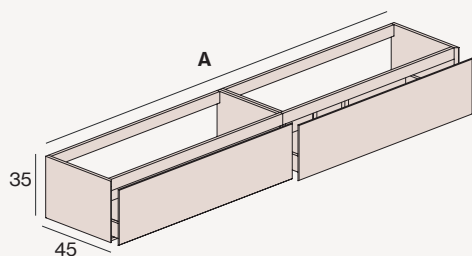

- Le composizioni asimmetriche hanno la seguente modulazione: 120 (80 + 40), 140 (80 + 60), 160 (100 + 60), 180 (120 + 60), 200 (120 + 80). Altre configurazioni disponibili.
- Mobili speciali: per misure intermedie in larghezza e / o altezza, prendere il prezzo della misura immediatamente superiore.
- L'armadio altezza 35 non dispone del sistema Decospace. Se l'installazione lo consente, può essere ordinato senza sovrapprezzo.

A (cm)	LAVABO	COD	LACCA		PANNELLO MULTISTRATO MARINO	
			TIRANTE DIAMOND	TIRANTE PUSH	TIRANTE DIAMOND	TIRANTE PUSH
60		D101.060.C	-	-	-	-
70		D101.070.C	-	-	-	-
80		D101.080.C	-	-	-	-
90		D101.090.C	-	-	-	-
100		D101.100.I	-	-	-	-
100		D101.100.C	-	-	-	-
100		D101.100.D	-	-	-	-
120		D101.120.I	-	-	-	-
120		D101.120.C	-	-	-	-
120		D101.120.D	-	-	-	-
120		D101.120.X	-	-	-	-
140		D101.140.I	-	-	-	-
140		D101.140.C	-	-	-	-
140		D101.140.D	-	-	-	-
140		D101.140.X	-	-	-	-
120		D102.120.I	-	-	-	-
120		D102.120.C	-	-	-	-
120		D102.120.D	-	-	-	-
140		D102.140.I	-	-	-	-
140		D102.140.C	-	-	-	-
140		D102.140.D	-	-	-	-
160		D102.160.I	-	-	-	-
160		D102.160.C	-	-	-	-
160		D102.160.D	-	-	-	-
180		D102.180.I	-	-	-	-
180		D102.180.C	-	-	-	-
180		D102.180.D	-	-	-	-
200		D102.200.I	-	-	-	-
200		D102.200.C	-	-	-	-
200		D102.200.D	-	-	-	-
120		D103.120.I	-	-	-	-
120		D103.120.D	-	-	-	-
120		D103.120.X	-	-	-	-
140		D103.140.I	-	-	-	-
140		D103.140.D	-	-	-	-
140		D103.140.X	-	-	-	-
160		D103.160.I	-	-	-	-
160		D103.160.D	-	-	-	-
160		D103.160.X	-	-	-	-
180		D103.180.I	-	-	-	-
180		D103.180.D	-	-	-	-
180		D103.180.X	-	-	-	-
200		D103.200.I	-	-	-	-
200		D103.200.D	-	-	-	-
200		D103.200.X	-	-	-	-

- C Lavabo centrato
- D Lavabo destro
- I Lavabo sinistro
- X Doppio lavabo

### BASI PER LAVABO SOSPESO

#### 2 CASSETTI

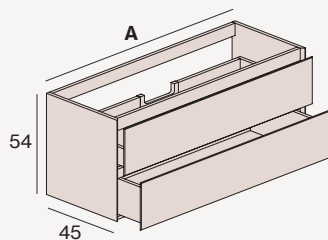

A (cm)	LAVABO	COD	LACCA		PANNELLO MULTISTRATO MARINO	
			TIRANTE DIAMOND	TIRANTE PUSH	TIRANTE DIAMOND	TIRANTE PUSH
60		D201.060.C	-	-	-	-
70		D201.070.C	-	-	-	-
80		D201.080.C	-	-	-	-
90		D201.090.C	-	-	-	-
100		D201.100.I	-	-	-	-
100		D201.100.C	-	-	-	-
100		D201.100.D	-	-	-	-
120		D201.120.I	-	-	-	-
120		D201.120.C	-	-	-	-
120		D201.120.D	-	-	-	-
120		D201.120.X	-	-	-	-
140		D201.140.I	-	-	-	-
140		D201.140.C	-	-	-	-
140		D201.140.D	-	-	-	-
140		D201.140.X	-	-	-	-

#### 1 CASSETTONE

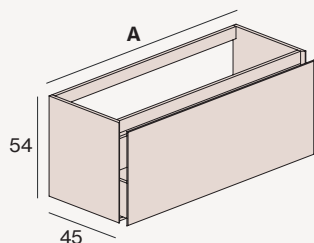

(1)

60		D202.060.C	-	-	-	-
70		D202.070.C	-	-	-	-
80		D202.080.C	-	-	-	-
90		D202.090.C	-	-	-	-
100		D202.100.I	-	-	-	-
100		D202.100.C	-	-	-	-
100		D202.100.D	-	-	-	-
120		D202.120.I	-	-	-	-
120		D202.120.C	-	-	-	-
120		D202.120.D	-	-	-	-
120		D202.120.X	-	-	-	-
140		D202.140.I	-	ND	-	ND
140		D202.140.C	-	ND	-	ND
140		D202.140.D	-	ND	-	ND
140		D202.140.X	-	ND	-	ND

#### 1 CASSETTO + DECORATIVO

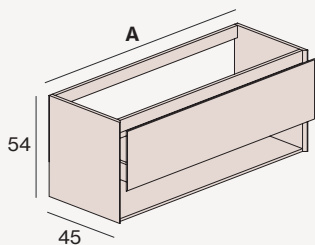

60		D203.060.C	-	-	-	-
70		D203.070.C	-	-	-	-
80		D203.080.C	-	-	-	-
90		D203.090.C	-	-	-	-
100		D203.100.I	-	-	-	-
100		D203.100.C	-	-	-	-
100		D203.100.D	-	-	-	-
120		D203.120.I	-	-	-	-
120		D203.120.C	-	-	-	-
120		D203.120.D	-	-	-	-
120		D203.120.X	-	-	-	-
140		D203.140.I	-	-	-	-
140		D203.140.C	-	-	-	-
140		D203.140.D	-	-	-	-
140		D203.140.X	-	-	-	-

Accessori

#### & complementi

COMPLETA  
IL TUO MOBILE  
Organizzatori,  
portasciugamani, ...  
pagina 148

#### (1) CASSETTO INTERNO

Il cassetto interno  
può essere inserito  
le composizioni  
con il tronco.

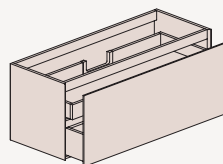

A (cm)	COD	PVP
40	A220.040	-
60	A220.060	-
70	A220.070	-
80	A220.080	-
90	A220.090	-
100	A220.100	-
120	A220.120	-
120X	A220.120X	-
140	A220.140	-
140X	A220.140X	-

### BASI PER LAVABO SOSPESO

#### CASSETTONE + 2 CASSETTI ASIMMETRICI

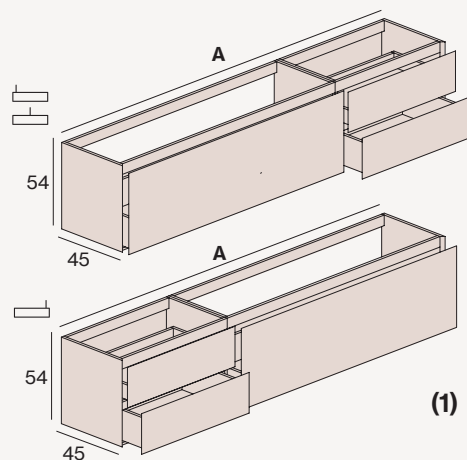

#### CASSETTONE + 2 CASSETTI

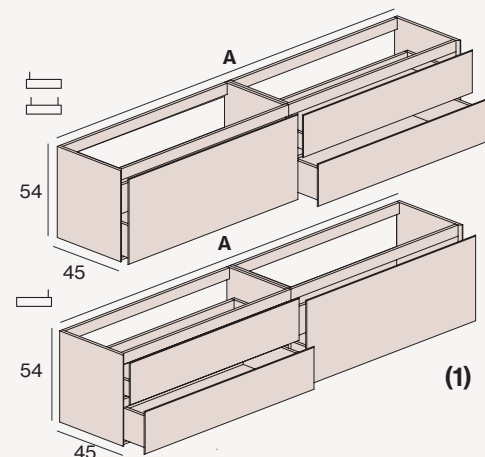

#### 4 CASSETTI ASIMMETRICI

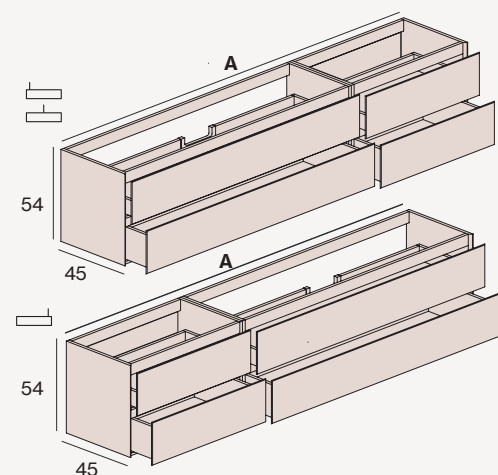

A (cm)	LAVABO	COD	LACCA		PANNELLO MULTISTRATO MARINO	
			TIRANTE DIAMOND	TIRANTE PUSH	TIRANTE DIAMOND	TIRANTE PUSH
120		D205.120.I	-	-	-	-
120		D205.120.C	-	-	-	-
120		D205.120.D	-	-	-	-
140		D205.140.I	-	-	-	-
140		D205.140.C	-	-	-	-
140		D205.140.D	-	-	-	-
160		D205.160.I	-	-	-	-
160		D205.160.C	-	-	-	-
160		D205.160.D	-	-	-	-
180		D205.180.I	-	-	-	-
180		D205.180.C	-	-	-	-
180		D205.180.D	-	-	-	-
200		D205.200.I	-	-	-	-
200		D205.200.C	-	-	-	-
200		D205.200.D	-	-	-	-
<hr/>						
120		D206.120.I	-	-	-	-
120		D206.120.D	-	-	-	-
120		D206.120.X	-	-	-	-
140		D206.140.I	-	-	-	-
140		D206.140.D	-	-	-	-
140		D206.140.X	-	-	-	-
160		D206.160.I	-	-	-	-
160		D206.160.D	-	-	-	-
160		D206.160.X	-	-	-	-
180		D206.180.I	-	-	-	-
180		D206.180.D	-	-	-	-
180		D206.180.X	-	-	-	-
200		D206.200.I	-	-	-	-
200		D206.200.D	-	-	-	-
200		D206.200.X	-	-	-	-
<hr/>						
120		D208.120.I	-	-	-	-
120		D208.120.C	-	-	-	-
120		D208.120.D	-	-	-	-
140		D208.140.I	-	-	-	-
140		D208.140.C	-	-	-	-
140		D208.140.D	-	-	-	-
160		D208.160.I	-	-	-	-
160		D208.160.C	-	-	-	-
160		D208.160.D	-	-	-	-
180		D208.180.I	-	-	-	-
180		D208.180.C	-	-	-	-
180		D208.180.D	-	-	-	-
200		D208.200.I	-	-	-	-
200		D208.200.C	-	-	-	-
200		D208.200.D	-	-	-	-



· Le composizioni asimmetriche hanno la seguente modulazione: 120 (80 + 40), 140 (80 + 60), 160 (100 + 60), 180 (120 + 60), 200 (120 + 80). Altre configurazioni disponibili.

· Mobili speciali: per misure intermedie in larghezza e / o altezza, prendere il prezzo della misura immediatamente superiore.

· L'armadio altezza 35 non dispone del sistema Decospace. Se l'installazione lo consente, può essere ordinato senza sovrapprezzo.

C Lavabo centrato  
 D Lavabo destro  
 I Lavabo sinistro  
 X Doppio lavabo

### BASI PER LAVABO SOSPESO

#### 4 CASSETTI SIMMETRICI

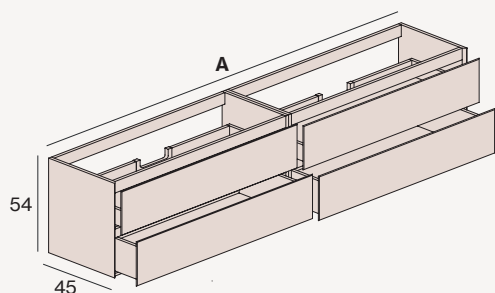

#### 2 CASSETTONI ASIMMETRICI

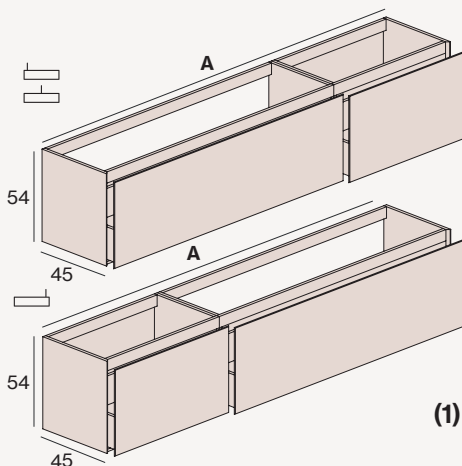

#### 2 CASSETTONI SIMMETRICI

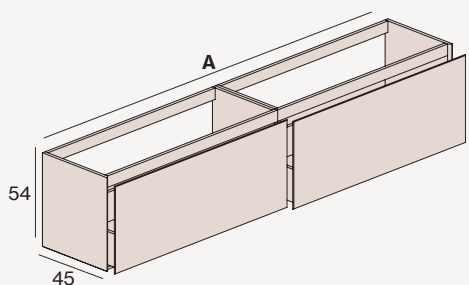

Accessori

A (cm)	LAVABO	COD	LACCA		PANNELLO MULTISTRATO MARINO	
			TIRANTE DIAMOND	TIRANTE PUSH	TIRANTE DIAMOND	TIRANTE PUSH
120		D209.120.I	-	-	-	-
120		D209.120.D	-	-	-	-
120		D209.120.X	-	-	-	-
140		D209.140.I	-	-	-	-
140		D209.140.D	-	-	-	-
140		D209.140.X	-	-	-	-
160		D209.160.I	-	-	-	-
160		D209.160.D	-	-	-	-
160		D209.160.X	-	-	-	-
180		D209.180.I	-	-	-	-
180		D209.180.D	-	-	-	-
180		D209.180.X	-	-	-	-
200		D209.200.I	-	-	-	-
200		D209.200.D	-	-	-	-
200		D209.200.X	-	-	-	-
120		D210.120.I	-	-	-	-
120		D210.120.C	-	-	-	-
120		D210.120.D	-	-	-	-
140		D210.140.I	-	-	-	-
140		D210.140.C	-	-	-	-
140		D210.140.D	-	-	-	-
160		D210.160.I	-	-	-	-
160		D210.160.C	-	-	-	-
160		D210.160.D	-	-	-	-
180		D210.180.I	-	-	-	-
180		D210.180.C	-	-	-	-
180		D210.180.D	-	-	-	-
200		D210.200.I	-	-	-	-
200		D210.200.C	-	-	-	-
200		D210.200.D	-	-	-	-
120		D211.120.I	-	-	-	-
120		D211.120.D	-	-	-	-
120		D211.120.X	-	-	-	-
140		D211.140.I	-	-	-	-
140		D211.140.D	-	-	-	-
140		D211.140.X	-	-	-	-
160		D211.160.I	-	-	-	-
160		D211.160.D	-	-	-	-
160		D211.160.X	-	-	-	-
180		D211.180.I	-	-	-	-
180		D211.180.D	-	-	-	-
180		D211.180.X	-	-	-	-
200		D211.200.I	-	-	-	-
200		D211.200.D	-	-	-	-
200		D211.200.X	-	-	-	-

#### & complementi

COMPLETA IL TUO MOBILE  
Organizzatori,  
portasciugamani,...  
pagina 148

#### (1) CASSETTO INTERNO

Il cassetto interno si puo' mettere nelle composizioni con cassettoni

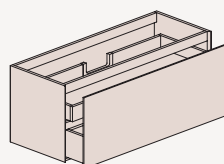

A (cm)	COD	PVP
40	A220.040	-
60	A220.060	-
70	A220.070	-
80	A220.080	-
90	A220.090	-
100	A220.100	-
120	A220.120	-
120X	A220.120X	-
140	A220.140	-
140X	A220.140X	-

### MODULI SOSPESI

#### 1 CASSETTO

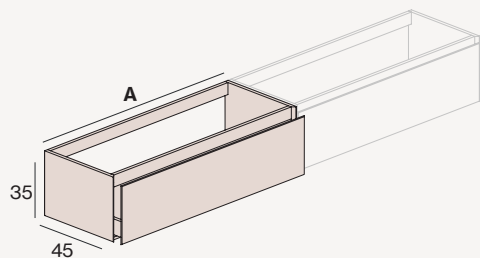

#### 2 CASSETTI

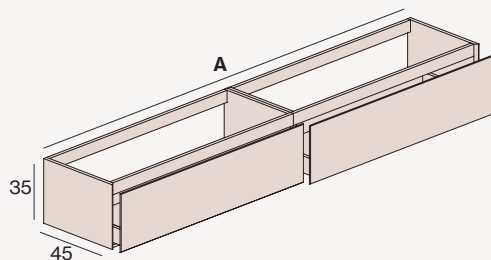

#### DECORATIVO

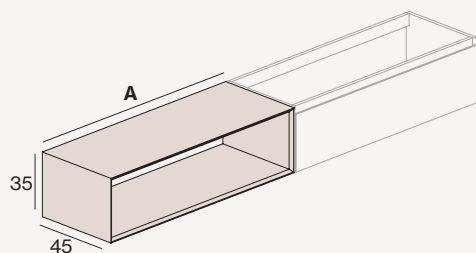

A (cm)	COD	LACCA		PANNELLO MULTISTRATO MARINO	
		TIRANTE DIAMOND	TIRANTE PUSH	TIRANTE DIAMOND	TIRANTE PUSH
30	D101.030.M	-	-	-	-
40	D101.040.M	-	-	-	-
60	D101.060.M	-	-	-	-
70	D101.070.M	-	-	-	-
80	D101.080.M	-	-	-	-
90	D101.090.M	-	-	-	-
100	D101.100.M	-	-	-	-
120	D101.120.M	-	-	-	-
140	D101.140.M	-	-	-	-

120	D103.120.M	-	-	-	-
140	D103.140.M	-	-	-	-
160	D103.160.M	-	-	-	-
180	D103.180.M	-	-	-	-
200	D103.200.M	-	-	-	-

30	D104.030.M	-	-	-	-
40	D104.040.M	-	-	-	-
60	D104.060.M	-	-	-	-
70	D104.070.M	-	-	-	-
80	D104.080.M	-	-	-	-



- Puoi creare il tuo arredo personalizzato aggiungendo i moduli a destra e / o sinistra della base lavabo selezionata.
- Specifica la loro posizione.



### MODULI SOSPESI

#### 1 CASSETTONE

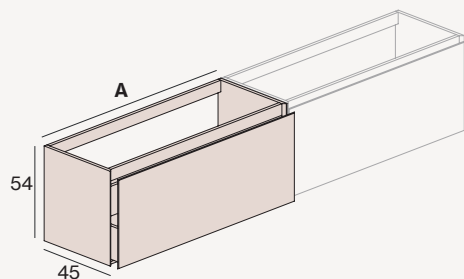

(1)

#### 1 CASSETTO + DECORATIVO

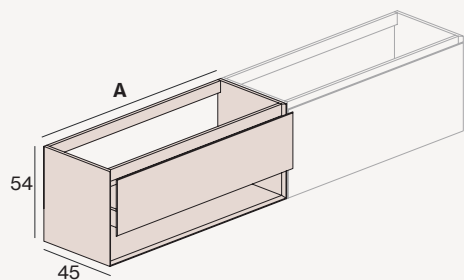

#### 2 CASSETTI

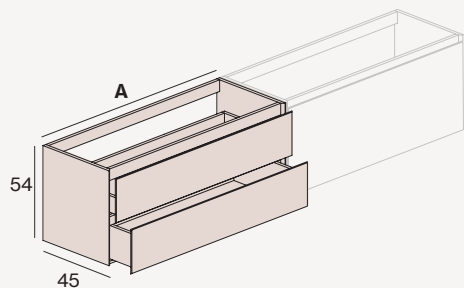

#### DECORATIVO + 1 RIPIANO

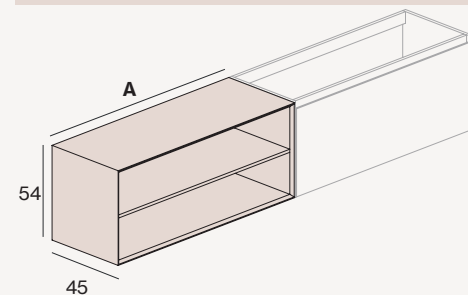

#### & complementi

COMPLETA  
IL TUO MOBILE  
Organizzatori,  
portasciugamani,...  
pagina 148

A (cm)	COD	LACCA		PANNELLO MULTISTRATO MARINO	
		TIRANTE DIAMOND	TIRANTE PUSH	TIRANTE DIAMOND	TIRANTE PUSH
30	D202.030.M	-	-	-	-
40	D202.040.M	-	-	-	-
60	D202.060.M	-	-	-	-
70	D202.070.M	-	-	-	-
80	D202.080.M	-	-	-	-
90	D202.090.M	-	-	-	-
100	D202.100.M	-	-	-	-
120	D202.120.M	-	-	-	-
140	D202.140.M	-	ND	-	ND

30	D203.030.M	-	-	-	-
40	D203.040.M	-	-	-	-
60	D203.060.M	-	-	-	-
70	D203.070.M	-	-	-	-
80	D203.080.M	-	-	-	-
90	D203.090.M	-	-	-	-
100	D203.100.M	-	-	-	-
120	D203.120.M	-	-	-	-
140	D203.140.M	-	-	-	-

30	D201.030.M	-	-	-	-
40	D201.040.M	-	-	-	-
60	D201.060.M	-	-	-	-
70	D201.070.M	-	-	-	-
80	D201.080.M	-	-	-	-
90	D201.090.M	-	-	-	-
100	D201.100.M	-	-	-	-
120	D201.120.M	-	-	-	-
140	D201.140.M	-	-	-	-

30	D207.030.M	-	-	-	-
40	D207.040.M	-	-	-	-
60	D207.060.M	-	-	-	-
70	D207.070.M	-	-	-	-
80	D207.080.M	-	-	-	-



#### (1) CASSETTO INTERNO

Il cassetto interno  
si puo' mettere  
nelle composizioni  
con cassettoni.

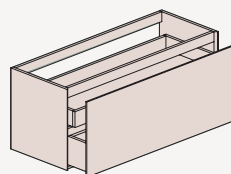

A (cm)	COD	PVP
40	A221.040	-
60	A221.060	-
70	A221.070	-
80	A221.080	-
90	A221.090	-
100	A221.100	-
120	A221.120	-
140	A221.140	-



# Best

Caratteristiche e attrezzature	124
Personalizza i tuoi mobili Best	125
Basi lavabo sospeso	126
Moduli sospesi	130
Accessori Atelier	148



## DECOSPACE SYSTEM

Sistema che prevede la fornitura di un sifone salvaspazio e di una valvola click clack cromata lucida. Questa soluzione evita l'inscatolamento del cassetto superiore, migliorando la capacità di contenimento e l'estetica degli interni poiché le strutture sono nascoste.



## CASSETTI 4D

Cassetti in metallo Hettich o Blum color antracite con profilo extra-sottile da 12 mm con 4 regolazioni. Le guide sono ad estrazione totale e impianto frenante progressivo.



## SU MISURA

Questa collezione consente la produzione personalizzata. In caso di misure intermedie in altezza e larghezza prendere il prezzo della misura immediatamente più alta.



## FULLCOLOR ANTRACITE

Idea di design d'interni per cui tutti i materiali degli interni dei mobili sono progettati in colore antracite. Il mobile con finitura laccata è internamente laccato antracite.



## DURALACK SYSTEM

I colori laccati contengono additivi indurenti che permettono alla finitura finale di essere altamente resistente allo sfregamento e all'abrasione.



## PUSH AND SLOW

I cassetti con il sistema di apertura senza maniglie "Push" hanno un sistema di sincronizzazione che permette loro di essere aperti premendo in qualsiasi punto del frontale. Allo stesso tempo, la chiusura è progressiva e silenziosa.



## DECOFIX SYSTEM

Sistema di fissaggio a muro ad alta sicurezza con il quale le resistenze al carico sono maggiori di 240 kg.



## DECOBUILD SYSTEM

Mobili realizzati con tavole da 19 mm incollate insieme ottenendo un'estetica pulita senza inserti visibili, offre una migliore resistenza e durevolezza.



## WOOD PROTECT SYSTEM

Il legno massello o di tavola marina sono protetti dagli agenti esterni con oli naturali che rispettano la consistenza e la natura del legno.



## ATELIER SYSTEM

Nelle finiture tavola marina o massello, i pezzi sono selezionati in modo numerato per rispettare la continuità delle venature in tutto il mobile.

## Configura e personalizza i tuoi mobili Best

### A Scegli la maniglia

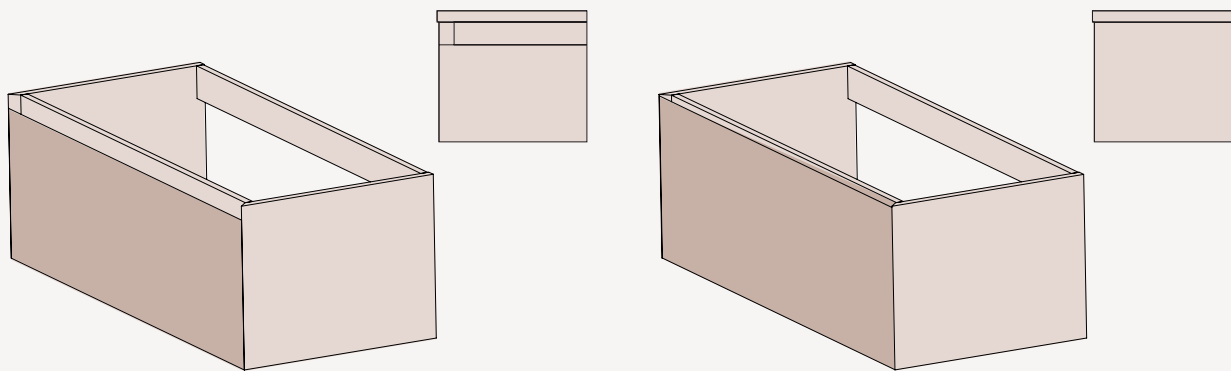

Best

Push

### B Scegli il colore

#### Laccato



#### Pannello Multistrato Marino / Impiallacciato Rovere e Noce

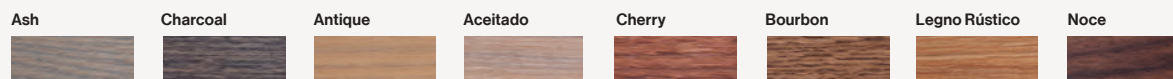

## BASI PER LAVABO SOSPESO

## 1 CASSETTO

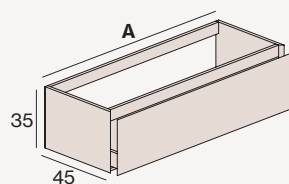

## 2 CASSETTIASIMMETRICI

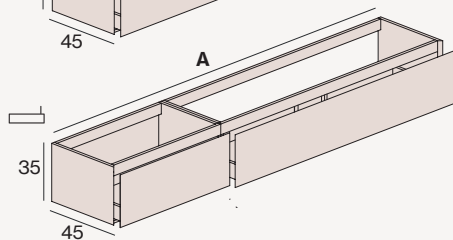
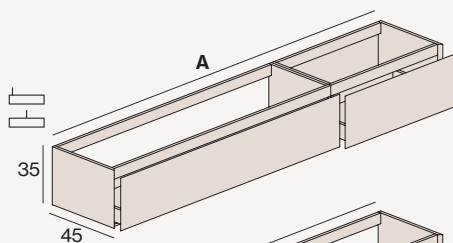

## 2 CASSETTISIMMETRICI

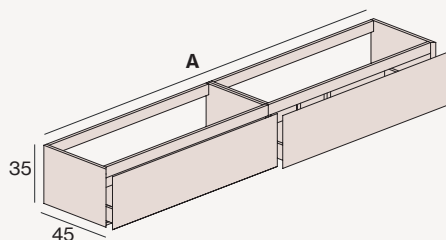

A (cm)	LAVABO	COD	LACCA		PANNELLO MULTISTRATO MARINO	
			TIRANTE BEST	TIRANTE PUSH	TIRANTE BEST	TIRANTE PUSH
60		B101.060.C	-	-	-	-
70		B101.070.C	-	-	-	-
80		B101.080.C	-	-	-	-
90		B101.090.C	-	-	-	-
100		B101.100.I	-	-	-	-
100		B101.100.C	-	-	-	-
100		B101.100.D	-	-	-	-
120		B101.120.I	-	-	-	-
120		B101.120.C	-	-	-	-
120		B101.120.D	-	-	-	-
120		B101.120.X	-	-	-	-
140		B101.140.I	-	-	-	-
140		B101.140.C	-	-	-	-
140		B101.140.D	-	-	-	-
140		B101.140.X	-	-	-	-
120		B102.120.I	-	-	-	-
120		B102.120.C	-	-	-	-
120		B102.120.D	-	-	-	-
140		B102.140.I	-	-	-	-
140		B102.140.C	-	-	-	-
140		B102.140.D	-	-	-	-
160		B102.160.I	-	-	-	-
160		B102.160.C	-	-	-	-
160		B102.160.D	-	-	-	-
180		B102.180.I	-	-	-	-
180		B102.180.C	-	-	-	-
180		B102.180.D	-	-	-	-
200		B102.200.I	-	-	-	-
200		B102.200.C	-	-	-	-
200		B102.200.D	-	-	-	-
120		B103.120.I	-	-	-	-
120		B103.120.D	-	-	-	-
120		B103.120.X	-	-	-	-
140		B103.140.I	-	-	-	-
140		B103.140.D	-	-	-	-
140		B103.140.X	-	-	-	-
160		B103.160.I	-	-	-	-
160		B103.160.D	-	-	-	-
160		B103.160.X	-	-	-	-
180		B103.180.I	-	-	-	-
180		B103.180.D	-	-	-	-
180		B103.180.X	-	-	-	-
200		B103.200.I	-	-	-	-
200		B103.200.D	-	-	-	-
200		B103.200.X	-	-	-	-



- Le composizioni asimmetriche hanno la seguente modulazione: 120 (80 + 40), 140 (80 + 60), 160 (100 + 60), 180 (120 + 60), 200 (120 + 80). Altre configurazioni disponibili.
- Mobili speciali: per misure intermedie in larghezza e / o altezza, prendere il prezzo della misura immediatamente superiore.
- L'armadio altezza 35 non dispone del sistema Decospace. Se l'installazione lo consente, può essere ordinato senza sovrapprezzo.

- C Lavabo centrato
- D Lavabo destro
- I Lavabo sinistro
- X Doppio lavabo

BASI PER LAVABO SOSPESO

2 CASSETTI

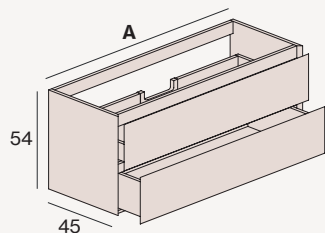

A (cm)	LAVABO	COD	LACCA		PANNELLO MULTISTRATO MARINO	
			TIRANTE BEST	TIRANTE PUSH	TIRANTE BEST	TIRANTE PUSH
60		B201.060.C	-	-	-	-
70		B201.070.C	-	-	-	-
80		B201.080.C	-	-	-	-
90		B201.090.C	-	-	-	-
100		B201.100.I	-	-	-	-
100		B201.100.C	-	-	-	-
100		B201.100.D	-	-	-	-
120		B201.120.I	-	-	-	-
120		B201.120.C	-	-	-	-
120		B201.120.D	-	-	-	-
120		B201.120.X	-	-	-	-
140		B201.140.I	-	-	-	-
140		B201.140.C	-	-	-	-
140		B201.140.D	-	-	-	-
140		B201.140.X	-	-	-	-

1 CASSETTONE

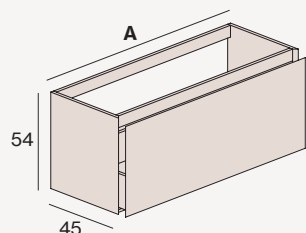

(1)

60		B202.060.C	-	-	-	-
70		B202.070.C	-	-	-	-
80		B202.080.C	-	-	-	-
90		B202.090.C	-	-	-	-
100		B202.100.I	-	-	-	-
100		B202.100.C	-	-	-	-
100		B202.100.D	-	-	-	-
120		B202.120.I	-	-	-	-
120		B202.120.C	-	-	-	-
120		B202.120.D	-	-	-	-
120		B202.120.X	-	-	-	-
140		B202.140.I	-	ND	-	ND
140		B202.140.C	-	ND	-	ND
140		B202.140.D	-	ND	-	ND
140		B202.140.X	-	ND	-	ND

1 CASSETTO + DECORATIVO

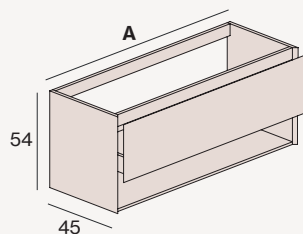

60		B203.060.C	-	-	-	-
70		B203.070.C	-	-	-	-
80		B203.080.C	-	-	-	-
90		B203.090.C	-	-	-	-
100		B203.100.I	-	-	-	-
100		B203.100.C	-	-	-	-
100		B203.100.D	-	-	-	-
120		B203.120.I	-	-	-	-
120		B203.120.C	-	-	-	-
120		B203.120.D	-	-	-	-
120		B203.120.X	-	-	-	-
140		B203.140.I	-	-	-	-
140		B203.140.C	-	-	-	-
140		B203.140.D	-	-	-	-
140		B203.140.X	-	-	-	-

Accessori

& complementi

COMPLETA  
IL TUO MOBILE  
Organizzatori,  
portasciugamani, ...  
pagina 148

(1) CASSETTO INTERNO

Nel cassetto interno  
si possono riporre  
le composizioni con  
cassettone.

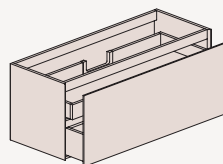

A (cm)	COD	PVP
40	A220.040	-
60	A220.060	-
70	A220.070	-
80	A220.080	-
90	A220.090	-
100	A220.100	-
120	A220.120	-
120X	A220.120X	-
140	A220.140	-
140X	A220.140X	-

## BASI PER LAVABO SOSPESO

## 1 CASSETTONE + 2 CASSETTI ASIMMETRICI

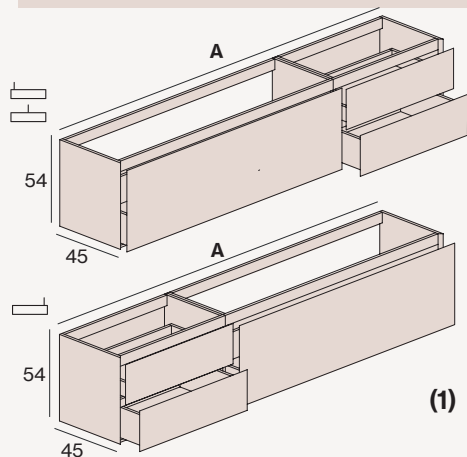

## 1 CASSETTONE + 2 CASSETTI ASIMMETRICI

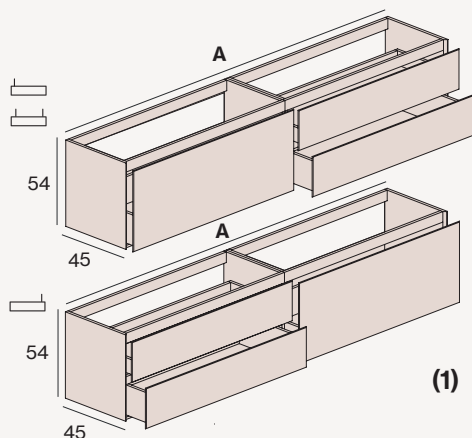

## 4 CASSETTI ASIMMETRICI

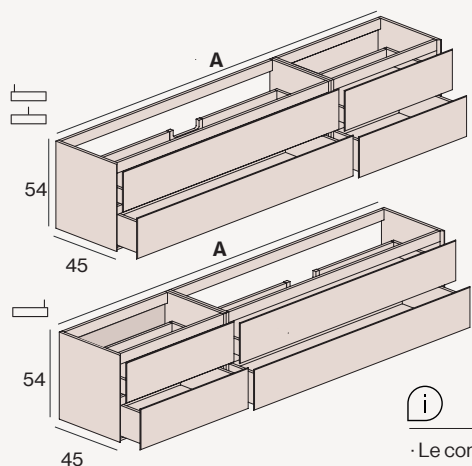

A (cm)	LAVABO	COD	LACCA		PANNELLO MULTISTRATO MARINO	
			TIRANTE BEST	TIRANTE PUSH	TIRANTE BEST	TIRANTE PUSH
120		B205.120.I	-	-	-	-
120		B205.120.C	-	-	-	-
120		B205.120.D	-	-	-	-
140		B205.140.I	-	-	-	-
140		B205.140.C	-	-	-	-
140		B205.140.D	-	-	-	-
160		B205.160.I	-	-	-	-
160		B205.160.C	-	-	-	-
160		B205.160.D	-	-	-	-
180		B205.180.I	-	-	-	-
180		B205.180.C	-	-	-	-
180		B205.180.D	-	-	-	-
200		B205.200.I	-	-	-	-
200		B205.200.C	-	-	-	-
200		B205.200.D	-	-	-	-

120		B206.120.I	-	-	-	-
120		B206.120.D	-	-	-	-
120		B206.120.X	-	-	-	-
140		B206.140.I	-	-	-	-
140		B206.140.D	-	-	-	-
140		B206.140.X	-	-	-	-
160		B206.160.I	-	-	-	-
160		B206.160.D	-	-	-	-
160		B206.160.X	-	-	-	-
180		B206.180.I	-	-	-	-
180		B206.180.D	-	-	-	-
180		B206.180.X	-	-	-	-
200		B206.200.I	-	-	-	-
200		B206.200.D	-	-	-	-
200		B206.200.X	-	-	-	-

120		B208.120.I	-	-	-	-
120		B208.120.C	-	-	-	-
120		B208.120.D	-	-	-	-
140		B208.140.I	-	-	-	-
140		B208.140.C	-	-	-	-
140		B208.140.D	-	-	-	-
160		B208.160.I	-	-	-	-
160		B208.160.C	-	-	-	-
160		B208.160.D	-	-	-	-
180		B208.180.I	-	-	-	-
180		B208.180.C	-	-	-	-
180		B208.180.D	-	-	-	-
200		B208.200.I	-	-	-	-
200		B208.200.C	-	-	-	-
200		B208.200.D	-	-	-	-



- Le composizioni asimmetriche hanno la seguente modulazione:  
120 (80 + 40), 140 (80 + 60), 160 (100 + 60), 180 (120 + 60), 200 (120 + 80).  
Altre configurazioni disponibili.
- Mobili speciali: per misure intermedie in larghezza e / o altezza, prendere il prezzo della misura immediatamente superiore.
- L'armadio altezza 35 non dispone del sistema Decospace. Se l'installazione lo consente, può essere ordinato senza sovrapprezzo.

- C Lavabo centrato
- D Lavabo destro
- I Lavabo sinistro
- X Doppio lavabo



BASI PER LAVABO SOSPESO

4 CASSETTI SIMMETRICI

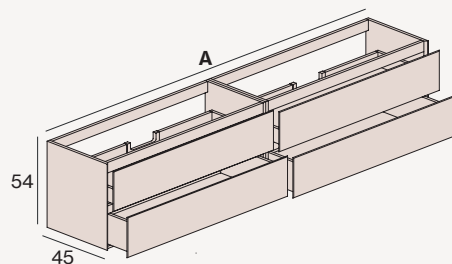

A (cm)	LAVABO	COD	LACCA		PANNELLO MULTISTRATO MARINO	
			TIRANTE BEST	TIRANTE PUSH	TIRANTE BEST	TIRANTE PUSH
120		B209.120.I	-	-	-	-
120		B209.120.D	-	-	-	-
120		B209.120.X	-	-	-	-
140		B209.140.I	-	-	-	-
140		B209.140.D	-	-	-	-
140		B209.140.X	-	-	-	-
160		B209.160.I	-	-	-	-
160		B209.160.D	-	-	-	-
160		B209.160.X	-	-	-	-
180		B209.180.I	-	-	-	-
180		B209.180.D	-	-	-	-
180		B209.180.X	-	-	-	-
200		B209.200.I	-	-	-	-
200		B209.200.D	-	-	-	-
200		B209.200.X	-	-	-	-

2 CASSETTONI ASIMMETRICI

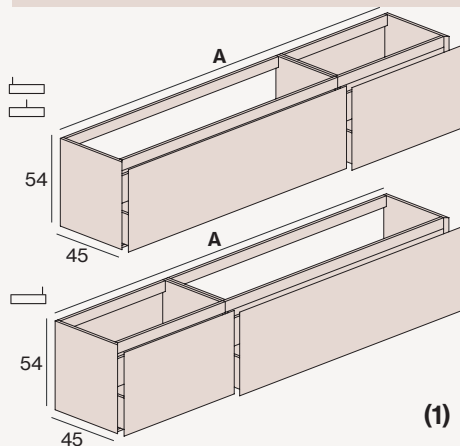

120		B210.120.I	-	-	-	-
120		B210.120.C	-	-	-	-
120		B210.120.D	-	-	-	-
140		B210.140.I	-	-	-	-
140		B210.140.C	-	-	-	-
140		B210.140.D	-	-	-	-
160		B210.160.I	-	-	-	-
160		B210.160.C	-	-	-	-
160		B210.160.D	-	-	-	-
180		B210.180.I	-	-	-	-
180		B210.180.C	-	-	-	-
180		B210.180.D	-	-	-	-
200		B210.200.I	-	-	-	-
200		B210.200.C	-	-	-	-
200		B210.200.D	-	-	-	-

2 CASSETTONI SIMMETRICI

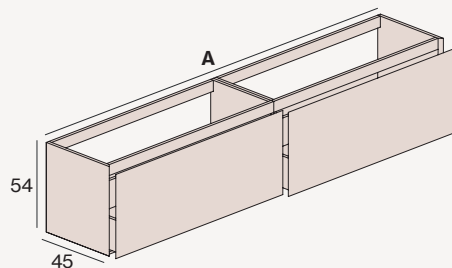

120		B211.120.I	-	-	-	-
120		B211.120.D	-	-	-	-
120		B211.120.X	-	-	-	-
140		B211.140.I	-	-	-	-
140		B211.140.D	-	-	-	-
140		B211.140.X	-	-	-	-
160		B211.160.I	-	-	-	-
160		B211.160.D	-	-	-	-
160		B211.160.X	-	-	-	-
180		B211.180.I	-	-	-	-
180		B211.180.D	-	-	-	-
180		B211.180.X	-	-	-	-
200		B211.200.I	-	-	-	-
200		B211.200.D	-	-	-	-
200		B211.200.X	-	-	-	-

Accessori

**& complementi**

COMPLETA  
IL TUO MOBILE  
Organizzatori,  
portasciugamani, ...  
pagina 148

**(1) CASSETTO INTERNO**

Nel cassetto interno  
si possono riporre  
le composizioni con  
cassettone.

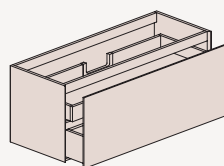

A (cm)	COD	PVP
40	A220.040	-
60	A220.060	-
70	A220.070	-
80	A220.080	-
90	A220.090	-
100	A220.100	-
120	A220.120	-
120X	A220.120X	-
140	A220.140	-
140X	A220.140X	-

## MODULI SOSPESI

## 1 CASSETTO

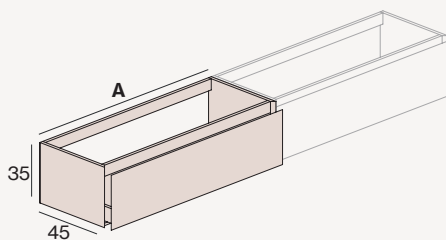

A (cm)	COD	LACCA		PANNELLO MULTISTRATO MARINO	
		TIRANTE BEST	TIRANTE PUSH	TIRANTE BEST	TIRANTE PUSH
30	B101.030.M	-	-	-	-
40	B101.040.M	-	-	-	-
60	B101.060.M	-	-	-	-
70	B101.070.M	-	-	-	-
80	B101.080.M	-	-	-	-
90	B101.090.M	-	-	-	-
100	B101.100.M	-	-	-	-
120	B101.120.M	-	-	-	-
140	B101.140.M	-	-	-	-

## 2 CASSETTI

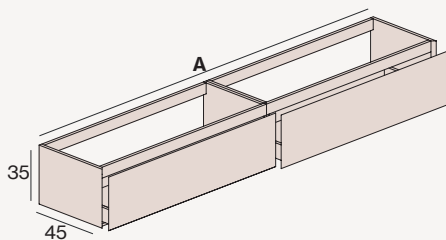

120	B103.120.M	-	-	-	-
140	B103.140.M	-	-	-	-
160	B103.160.M	-	-	-	-
180	B103.180.M	-	-	-	-
200	B103.200.M	-	-	-	-

## DECORATIVO

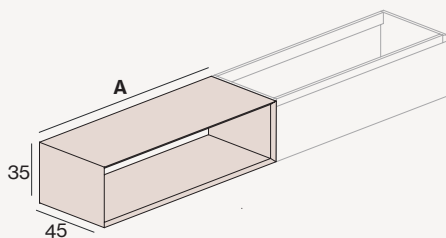

30	B104.030.M	-	-	-	-
40	B104.040.M	-	-	-	-
60	B104.060.M	-	-	-	-
70	B104.070.M	-	-	-	-
80	B104.080.M	-	-	-	-

### MODULI SOSPESI

#### 1 CASSETTONE

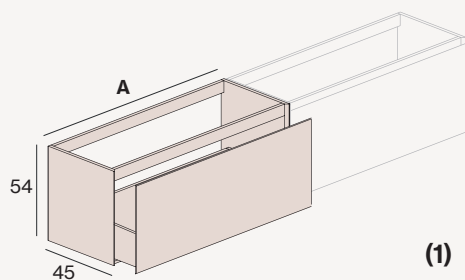

A (cm)	COD	LACCA		PANNELLO MULTISTRATO MARINO	
		TIRANTE BEST	TIRANTE PUSH	TIRANTE BEST	TIRANTE PUSH
30	B202.030.M	-	-	-	-
40	B202.040.M	-	-	-	-
60	B202.060.M	-	-	-	-
70	B202.070.M	-	-	-	-
80	B202.080.M	-	-	-	-
90	B202.090.M	-	-	-	-
100	B202.100.M	-	-	-	-
120	B202.120.M	-	-	-	-
140	B202.140.M	-	ND	-	ND

#### 1 CASSETTO + DECORATIVO

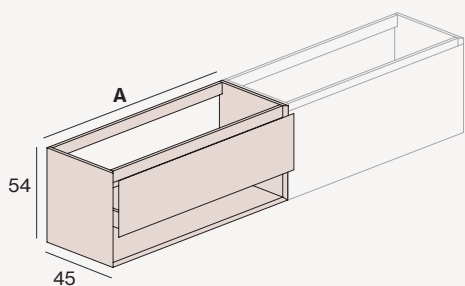

30	B203.030.M	-	-	-	-
40	B203.040.M	-	-	-	-
60	B203.060.M	-	-	-	-
70	B203.070.M	-	-	-	-
80	B203.080.M	-	-	-	-
90	B203.090.M	-	-	-	-
100	B203.100.M	-	-	-	-
120	B203.120.M	-	-	-	-
140	B203.140.M	-	-	-	-

#### 2 CASSETTI

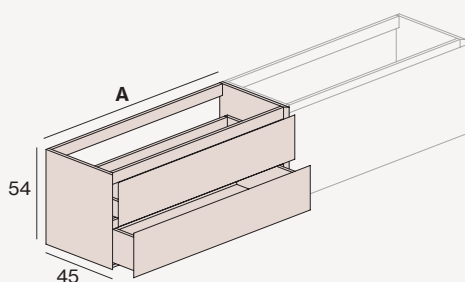

30	B201.030.M	-	-	-	-
40	B201.040.M	-	-	-	-
60	B201.060.M	-	-	-	-
70	B201.070.M	-	-	-	-
80	B201.080.M	-	-	-	-
90	B201.090.M	-	-	-	-
100	B201.100.M	-	-	-	-
120	B201.120.M	-	-	-	-
140	B201.140.M	-	-	-	-

#### DECORATIVO 2 RIPIANI

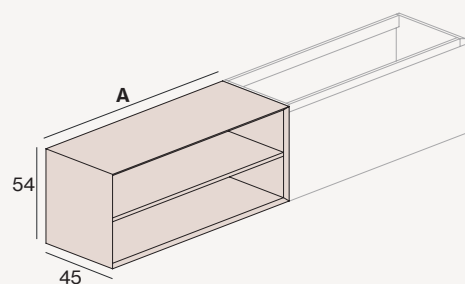

30	B207.030.M	-	-	-	-
40	B207.040.M	-	-	-	-
60	B207.060.M	-	-	-	-
70	B207.070.M	-	-	-	-
80	B207.080.M	-	-	-	-

#### (1) CASSETTO INTERNO

Nel cassetto interno si possono riporre le composizioni con cassettone.

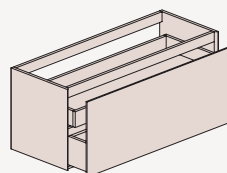

A (cm)	COD	PVP
40	A221.040	-
60	A221.060	-
70	A221.070	-
80	A221.080	-
90	A221.090	-
100	A221.100	-
120	A221.120	-
140	A221.140	-



- Puoi creare il tuo arredo personalizzato aggiungendo i moduli a destra e / o sinistra della base lavabo selezionata.
- Specifica la loro posizione.

#### & complementi

COMPLETA IL TUO MOBILE  
Organizzatori,  
portasciugamani, ...  
pagina 148



# Queen

Caratteristiche e attrezzature	134
Personalizza i tuoi mobili Queen	135
Basi lavabo sospese	136
Moduli sospesi	139
Accessori Atelier	148



## DECOSPACE SYSTEM

Sistema che prevede la fornitura di un sifone salvaspazio e di una valvola click clack cromata lucida. Questa soluzione evita l'inscatolamento del cassetto superiore, migliorando la capacità di contenimento e l'estetica degli interni poiché le strutture sono nascoste.



## CASSETTI 4D

Cassetti in metallo Hettich o Blum color antracite con profilo extra-sottile da 12 mm con 4 regolazioni. Le guide sono ad estrazione totale e impianto frenante progressivo.



## SU MISURA

Questa collezione consente la produzione personalizzata. In caso di misure intermedie in altezza e larghezza prendere il prezzo della misura immediatamente più alta.



## FULLCOLOR ANTRACITE

Idea di design d'interni per cui tutti i materiali degli interni dei mobili sono progettati in colore antracite. Il mobile con finitura laccata è internamente laccato antracite.



## DURALACK SYSTEM

I colori laccati contengono additivi indurenti che permettono alla finitura finale di essere altamente resistente allo sfregamento e all'abrasione.



## DECOFIX SYSTEM

Sistema di fissaggio a muro ad alta sicurezza con il quale le resistenze al carico sono maggiori di 240 kg.



## DECOBUILD SYSTEM

Mobili realizzati con tavole da 19 mm incollate insieme ottenendo un'estetica pulita senza inserti visibili, offre una migliore resistenza e durevolezza.

Queen ti rende tutto facile. Per personalizzare i tuoi mobili, devi solo scegliere il colore e la maniglia desiderata

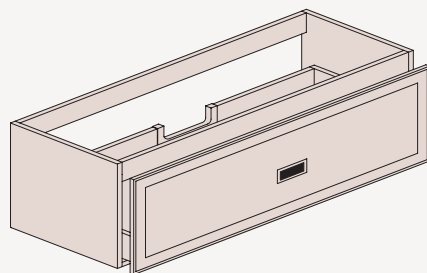

**A** Scegli il tuo colore laccato



\* Disponibile in tutti i colori RAL

**B** Scegli la tua maniglia

Oro lucido

Bordo decorato



Sparatutto

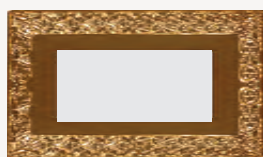

Cromo lucido

Bordo decorato

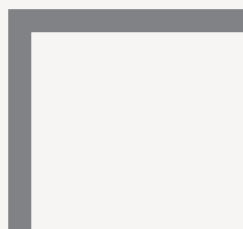

Sparatutto



## BASI PER LAVABO SOSPESO

## 1 CASSETTO

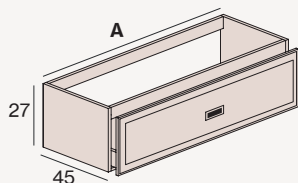

A (cm)	LAVABO	COD	PVP
60		Q101.060.C	-
70		Q101.070.C	-
80		Q101.080.C	-
90		Q101.090.C	-
100		Q101.100.I	-
100		Q101.100.C	-
100		Q101.100.D	-
120		Q101.120.I	-
120		Q101.120.C	-
120		Q101.120.D	-
120		Q101.120.X	-
140		Q101.140.I	-
140		Q101.140.C	-
140		Q101.140.D	-
140		Q101.140.X	-

## 2 CASSETTIASIMMETRICI

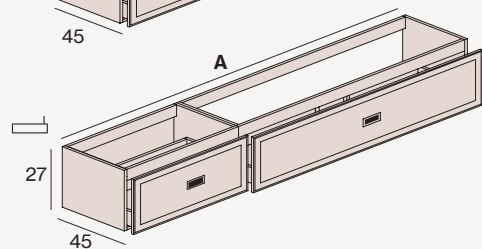
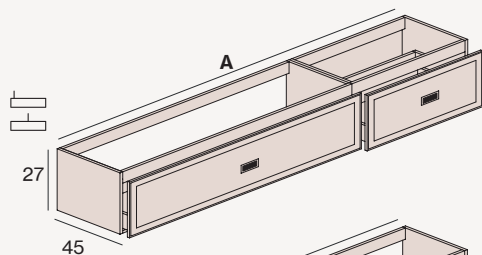

120		Q102.120.I	-
120		Q102.120.C	-
120		Q102.120.D	-
140		Q102.140.I	-
140		Q102.140.C	-
140		Q102.140.D	-
160		Q102.160.I	-
160		Q102.160.C	-
160		Q102.160.D	-
180		Q102.180.I	-
180		Q102.180.C	-
180		Q102.180.D	-
200		Q102.200.I	-
200		Q102.200.C	-
200		Q102.200.D	-

## 2 CASSETTI SIMMETRICI

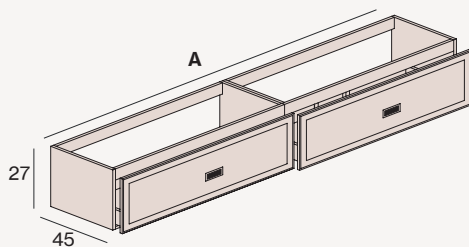

120		Q103.120.I	-
120		Q103.120.D	-
120		Q103.120.X	-
140		Q103.140.I	-
140		Q103.140.D	-
140		Q103.140.X	-
160		Q103.160.I	-
160		Q103.160.D	-
160		Q103.160.X	-
180		Q103.180.I	-
180		Q103.180.D	-
180		Q103.180.X	-
200		Q103.200.I	-
200		Q103.200.D	-
200		Q103.200.X	-



- Le composizioni asimmetriche hanno la seguente modulazione: 120 (80 + 40), 140 (80 + 60), 160 (100 + 60), 180 (120 + 60), 200 (120 + 80). Altre impostazioni disponibili.
- Mobili speciali: per misure intermedie in larghezza e / o altezza, prendere il prezzo della misura successiva più alta. Sfondo speciale disponibile da 39 a 45 cm. Consulta altri fondi.
- Il mobile con altezza 27 non dispone del sistema Decospace. Se l'installazione lo consente, può essere ordinato senza sovrapprezzo.

- C Lavabo centrato
- D Lavabo destro
- I Lavabo sinistro
- X Doppio lavabo



BASI PER LAVABO SOSPESO

2 CASSETTI

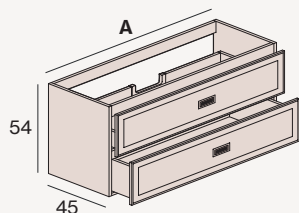

A (cm)	LAVABO	COD	PVP
60		Q201.060.C	-
70		Q201.070.C	-
80		Q201.080.C	-
90		Q201.090.C	-
100		Q201.100.I	-
100		Q201.100.C	-
100		Q201.100.D	-
120		Q201.120.I	-
120		Q201.120.C	-
120		Q201.120.D	-
120		Q201.120.X	-
140		Q201.140.I	-
140		Q201.140.C	-
140		Q201.140.D	-
140		Q201.140.X	-

4 CASSETTI ASIMMETRICI

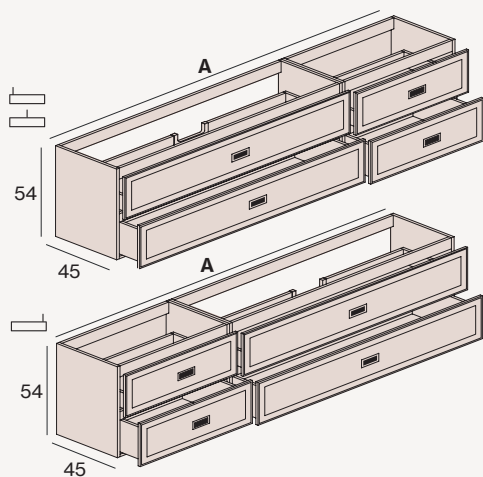

120		Q208.120.I	-
120		Q208.120.C	-
120		Q208.120.D	-
140		Q208.140.I	-
140		Q208.140.C	-
140		Q208.140.D	-
160		Q208.160.I	-
160		Q208.160.C	-
160		Q208.160.D	-
180		Q208.180.I	-
180		Q208.180.C	-
180		Q208.180.D	-
200		Q208.200.I	-
200		Q208.200.C	-
200		Q208.200.D	-

4 CASSETTI SIMMETRICI

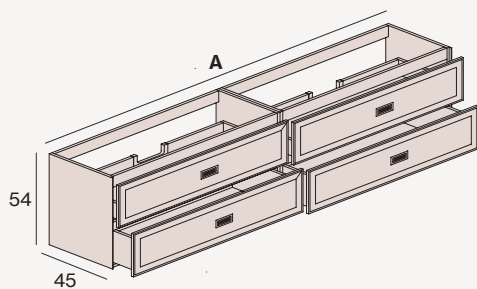

120		Q209.120.I	-
120		Q209.120.D	-
120		Q209.120.X	-
140		Q209.140.I	-
140		Q209.140.D	-
140		Q209.140.X	-
160		Q209.160.I	-
160		Q209.160.D	-
160		Q209.160.X	-
180		Q209.180.I	-
180		Q209.180.D	-
180		Q209.180.X	-
200		Q209.200.I	-
200		Q209.200.D	-
200		Q209.200.X	-

Accessori





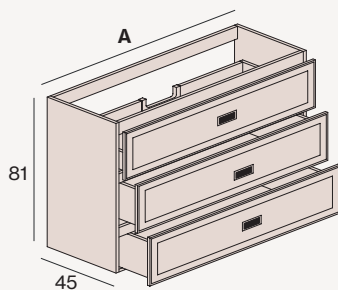

**& complementi**

COMPLETA  
IL TUO MOBILE  
Organizzatori,  
portasciugamani, ...  
pagina 148

## BASI PER LAVABO SOSPESO





## 3 CASSETTI



A (cm)	LAVABO	COD	PVP
60		Q213.060.C	-
70		Q213.070.C	-
80		Q213.080.C	-
90		Q213.090.C	-
100		Q213.100.I	-
100		Q213.100.C	-
100		Q213.100.D	-



- Le composizioni asimmetriche hanno la seguente modulazione: 120 (80 + 40), 140 (80 + 60), 160 (100 + 60), 180 (120 + 60), 200 (120 + 80). Altre impostazioni disponibili.
- Mobili speciali: per misure intermedie in larghezza e / o altezza, prendere il prezzo della misura successiva più alta. Sfondo speciale disponibile da 39 a 45 cm. Consulta altri fondi.

-  C Lavabo centrato
-  D Lavabo destro
-  I Lavabo sinistro
-  X Doppio lavabo

## MODULI SOSPESI

## 1 CASSETTO

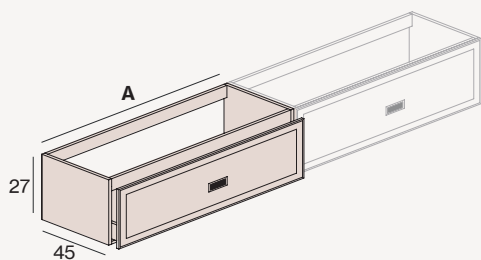

A (cm)	COD	TIRATORE	PVP
40	Q101.040.M	-	-
60	Q101.060.M	-	-
70	Q101.070.M	-	-
80	Q101.080.M	-	-
90	Q101.090.M	-	-
100	Q101.100.M	-	-
120	Q101.120.M	-	-
140	Q101.140.M	-	-

## 2 CASSETTI

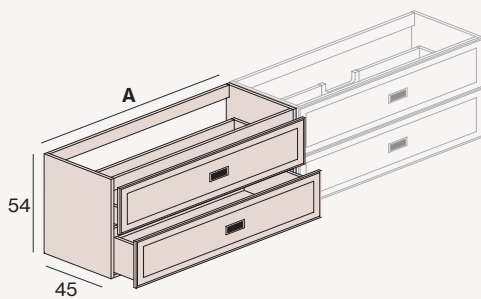

40	Q201.040.M	-	-
60	Q201.060.M	-	-
70	Q201.070.M	-	-
80	Q201.080.M	-	-
90	Q201.090.M	-	-
100	Q201.100.M	-	-
120	Q201.120.M	-	-
140	Q201.140.M	-	-

## 3 CASSETTI

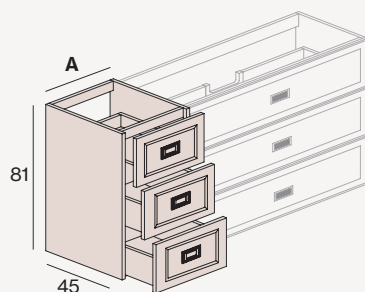

40	Q313.040.M	-	-
60	Q313.060.M	-	-
70	Q313.070.M	-	-
80	Q313.080.M	-	-
90	Q313.090.M	-	-
100	Q313.100.M	-	-

**& complementi**

COMPLETA  
IL TUO MOBILE  
Organizzatori,  
portasciugamani, ...  
pagina 148

- Puoi creare il tuo arredo personalizzato aggiungendo i moduli a destra e / o sinistra della base lavabo selezionata.
- Specifica la loro posizione.



# Alma by **CIRCULO CUADRADO**

Caratteristiche e attrezzature	142
Personalizza i tuoi mobili Alma	143
Basi lavabo sospese	144
Moduli sospesi	146
Accessori Atelier	148



### DECOSPACE SYSTEM

Sistema che prevede la fornitura di un sifone salvaspazio e di una valvola click clack cromata lucida. Questa soluzione evita l'inscatolamento del cassetto superiore, migliorando la capacità di contenimento e l'estetica degli interni poiché le strutture sono nascoste.



### CASSETTI 4D

Cassetti in metallo Hettich o Blum color antracite con profilo extra-sottile da 12 mm con 4 regolazioni. Le guide sono ad estrazione totale e impianto frenante progressivo.



### SU MISURA

Questa collezione consente la produzione personalizzata. In caso di misure intermedie in altezza e larghezza prendere il prezzo della misura immediatamente più alta.



### FULLCOLOR ANTRACITE

Idea di design d'interni per cui tutti i materiali degli interni dei mobili sono progettati in colore antracite. Il mobile con finitura laccata è internamente laccato antracite.



### DURALACK SYSTEM

I colori laccati contengono additivi indurenti che permettono alla finitura finale di essere altamente resistente allo sfregamento e all'abrasione.



### PUSH AND SLOW

I cassetti con il sistema di apertura senza maniglie "Push" hanno un sistema di sincronizzazione che permette loro di essere aperti premendo in qualsiasi punto del frontale. Allo stesso tempo, la chiusura è progressiva e silenziosa.



### DECOFIX SYSTEM

Sistema di fissaggio a muro ad alta sicurezza con il quale le resistenze al carico sono maggiori di 240 kg.



### DECOBUILD SYSTEM

Mobili realizzati con tavole da 19 mm incollate insieme ottenendo un'estetica pulita senza inserti visibili, offre una migliore resistenza e durevolezza.



### WOOD PROTECT SYSTEM

Il legno massello o di tavola marina sono protetti dagli agenti esterni con oli naturali che rispettano la consistenza e la natura del legno.



### ATELIER SYSTEM

Nelle finiture tavola marina o massello, i pezzi sono selezionati in modo numerato per rispettare la continuità delle venature in tutto il mobile.

## Configura e personalizza i tuoi mobili Alma

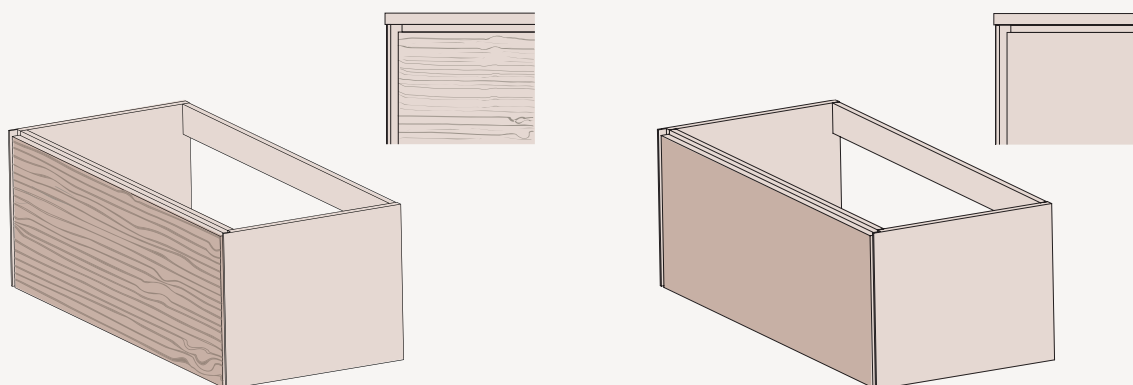

Frontale in legno

Frontale laccato

### A Scegli il colore della struttura del mobile

#### Lacados



### B Scegli il colore del frontale PUSH

#### Laccato



#### Pannello Multistrato Marino / Impiallacciato Rovere e Noce

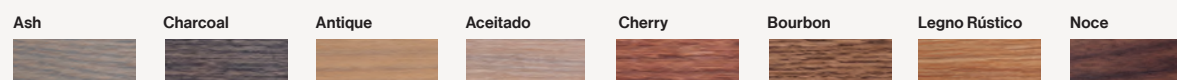

#### Legno Massello / Rovere



## BASI PER LAVABO SOSPESO

## 1 CASSETTO

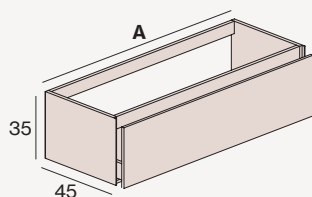

A (cm)	LAVABO	COD	LACCA	P. MULTISTRATO MARINO	LEGNO MASSELLO
(solo frontale, struttura laccata)					
60		A101.060.C	-	-	-
70		A101.070.C	-	-	-
80		A101.080.C	-	-	-
90		A101.090.C	-	-	-
100		A101.100.I	-	-	-
100		A101.100.C	-	-	-
100		A101.100.D	-	-	-
120		A101.120.I	-	-	-
120		A101.120.C	-	-	-
120		A101.120.D	-	-	-
120		A101.120.X	-	-	-
140		A101.140.I	-	-	-
140		A101.140.C	-	-	-
140		A101.140.D	-	-	-
140		A101.140.X	-	-	-

## 2 CASSETTI ASIMMETRICI

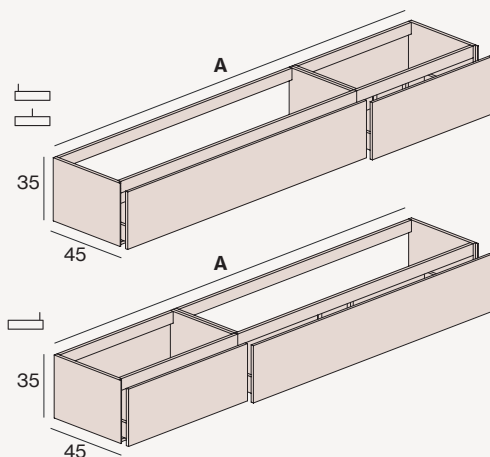

120		A102.120.I	-	-	-
120		A102.120.C	-	-	-
120		A102.120.D	-	-	-
140		A102.140.I	-	-	-
140		A102.140.C	-	-	-
140		A102.140.D	-	-	-
160		A102.160.I	-	-	-
160		A102.160.C	-	-	-
160		A102.160.D	-	-	-
180		A102.180.I	-	-	-
180		A102.180.C	-	-	-
180		A102.180.D	-	-	-
200		A102.200.I	-	-	-
200		A102.200.C	-	-	-
200		A102.200.D	-	-	-

## 2 CASSETTI SIMMETRICI

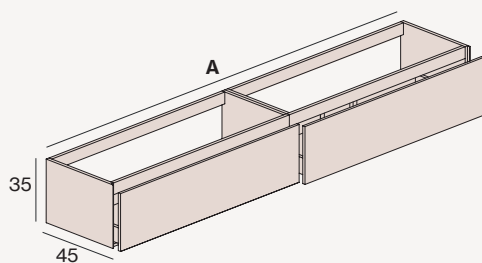

120		A103.120.I	-	-	-
120		A103.120.D	-	-	-
120		A103.120.X	-	-	-
140		A103.140.I	-	-	-
140		A103.140.D	-	-	-
140		A103.140.X	-	-	-
160		A103.160.I	-	-	-
160		A103.160.D	-	-	-
160		A103.160.X	-	-	-
180		A103.180.I	-	-	-
180		A103.180.D	-	-	-
180		A103.180.X	-	-	-
200		A103.200.I	-	-	-
200		A103.200.D	-	-	-
200		A103.200.X	-	-	-



- Le composizioni asimmetriche hanno la seguente modulazione: 120 (80 + 40), 140 (80 + 60), 160 (100 + 60), 180 (120 + 60), 200 (120 + 80). Altre configurazioni disponibili.
- Mobili speciali: per misure intermedie in larghezza e / o altezza, prendere il prezzo della misura immediatamente superiore.
- L'armadio altezza 35 non dispone del sistema Decospace. Se l'installazione lo consente, può essere ordinato senza sovrapprezzo.

**& complementi**

COMPLETA  
IL TUO MOBILE  
Organizzatori,  
portasciugamani, ...  
pagina 148

- C Lavabo centrato
- D Lavabo destro
- I Lavabo sinistro
- X Doppio lavabo



## BASI PER LAVABO SOSPESO

## 2 CASSETTI

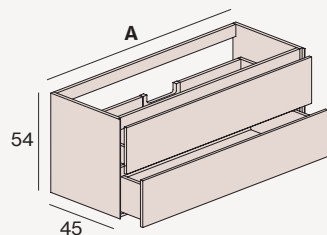

A (cm)	LAVABO	COD	LACCA	P. MULTISTRATO MARINO	LEGNO MASSELLO
(solo frontale, struttura laccata)					
60		A202.060.C	-	-	-
70		A202.070.C	-	-	-
80		A202.080.C	-	-	-
90		A202.090.C	-	-	-
100		A202.100.I	-	-	-
100		A202.100.C	-	-	-
100		A202.100.D	-	-	-
120		A202.120.I	-	-	-
120		A202.120.C	-	-	-
120		A202.120.D	-	-	-
120		A202.120.X	-	-	-
140		A202.140.I	-	-	-
140		A202.140.C	-	-	-
140		A202.140.D	-	-	-
140		A202.140.X	-	-	-

## 1 CASSETTO + DECORATIVO

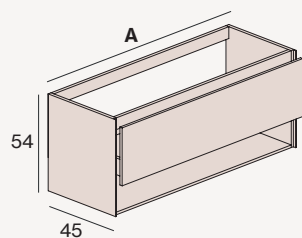

60		A203.060.C	-	-	-
70		A203.070.C	-	-	-
80		A203.080.C	-	-	-
90		A203.090.C	-	-	-
100		A203.100.I	-	-	-
100		A203.100.C	-	-	-
100		A203.100.D	-	-	-
120		A203.120.I	-	-	-
120		A203.120.C	-	-	-
120		A203.120.D	-	-	-
120		A203.120.X	-	-	-
140		A203.140.I	-	-	-
140		A203.140.C	-	-	-
140		A203.140.D	-	-	-
140		A203.140.X	-	-	-

## 4 CASSETTI ASIMMETRICI

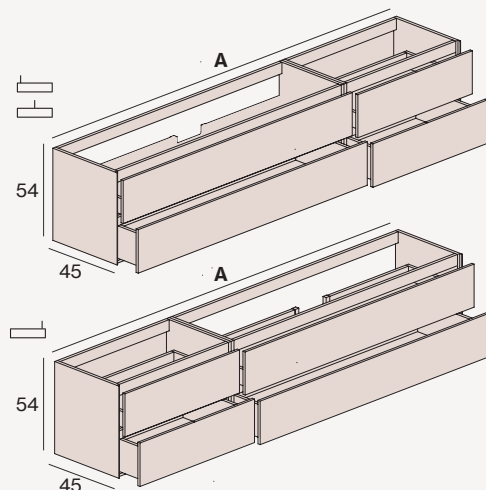

120		A208.120.I	-	-	-
120		A208.120.C	-	-	-
120		A208.120.D	-	-	-
140		A208.140.I	-	-	-
140		A208.140.C	-	-	-
140		A208.140.D	-	-	-
160		A208.160.I	-	-	-
160		A208.160.C	-	-	-
160		A208.160.D	-	-	-
180		A208.180.I	-	-	-
180		A208.180.C	-	-	-
180		A208.180.D	-	-	-
200		A208.200.I	-	-	-
200		A208.200.C	-	-	-
200		A208.200.D	-	-	-



## &amp; complementi

COMPLETA  
IL TUO MOBILE  
Organizzatori,  
portasciugamani, ...  
pagina 148

- C Lavabo centrato
- D Lavabo destro
- I Lavabo sinistro
- X Doppio lavabo

## BASI PER LAVABO SOSPESO

## 4 CASSETTI SIMMETRICI

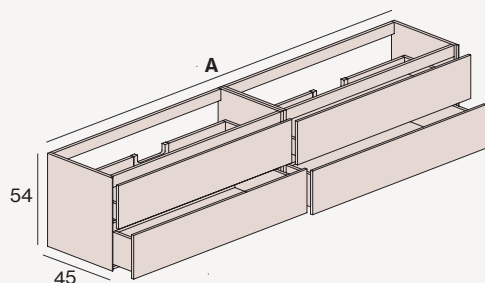

A (cm)	LAVABO	COD	LACCA	P. MULTISTRATO MARINO	LEGNO MASSELLO
(solo frontale, struttura laccata)					
120		A209.120.I	-	-	-
120		A209.120.D	-	-	-
120		A209.120.X	-	-	-
140		A209.140.I	-	-	-
140		A209.140.D	-	-	-
140		A209.140.X	-	-	-
160		A209.160.I	-	-	-
160		A209.160.D	-	-	-
160		A209.160.X	-	-	-
180		A209.180.I	-	-	-
180		A209.180.D	-	-	-
180		A209.180.X	-	-	-
200		A209.200.I	-	-	-
200		A209.200.D	-	-	-
200		A209.200.X	-	-	-

## MODULI SOSPESI

## 1 CASSETTO

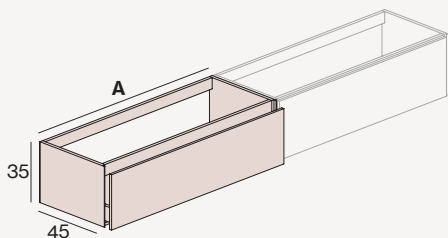

A (cm)	COD	LACCA	P. MULTISTRATO MARINO	LEGNO MASSELLO
(solo frontale, struttura laccata)				
30	A101.030.M	-	-	-
40	A101.040.M	-	-	-
60	A101.060.M	-	-	-
70	A101.070.M	-	-	-
80	A101.080.M	-	-	-
90	A101.090.M	-	-	-
100	A101.100.M	-	-	-
120	A101.120.M	-	-	-
140	A101.140.M	-	-	-

## 2 CASSETTI

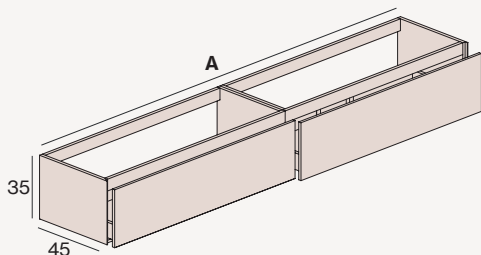

120	A103.120.M	-	-	-
140	A103.140.M	-	-	-
160	A103.160.M	-	-	-
180	A103.180.M	-	-	-
200	A103.200.M	-	-	-



Puoi creare il tuo arredo personalizzato aggiungendo i moduli a destra e / o sinistra della base lavabo selezionata. Specifica la loro posizione.

**& complementi**

COMPLETA  
IL TUO MOBILE  
Organizzatori,  
portasciugamani, ...  
pagina 148

- C Lavabo centrato
- D Lavabo destro
- I Lavabo sinistro
- X Doppio lavabo

## MODULI SOSPESI

## DECORATIVO

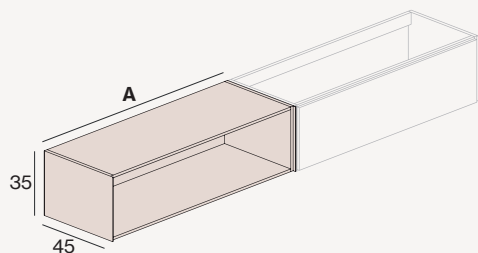

A (cm)	COD	LACCA
30	A104.030.M	-
40	A104.040.M	-
60	A104.060.M	-
70	A104.070.M	-
80	A104.080.M	-

## DECORATIVO + 1 RIPIANO

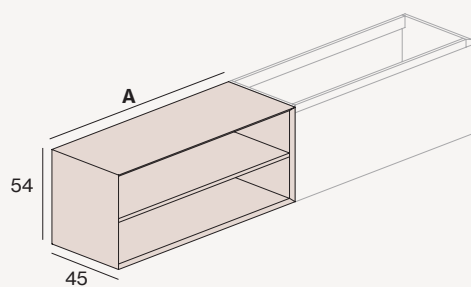

30	A207.030.M	-
40	A207.040.M	-
60	A207.060.M	-
70	A207.070.M	-
80	A207.080.M	-

## 2 CASSETTI

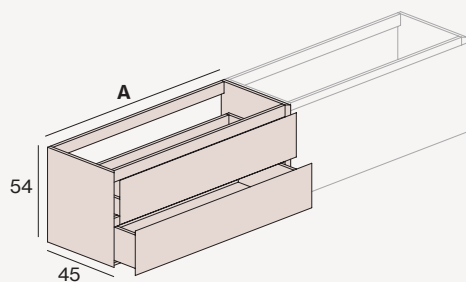

A (cm)	COD	LACCA	P. MULTISTRATO MARINO	LEGNO MASSELLO
(solo frontale, struttura laccata)				
30	A201.030.M	-	-	-
40	A201.040.M	-	-	-
60	A201.060.M	-	-	-
70	A201.070.M	-	-	-
80	A201.080.M	-	-	-
90	A201.090.M	-	-	-
100	A201.100.M	-	-	-
120	A201.120.M	-	-	-
140	A201.140.M	-	-	-

## 1 CASSETTO + DECORATIVO

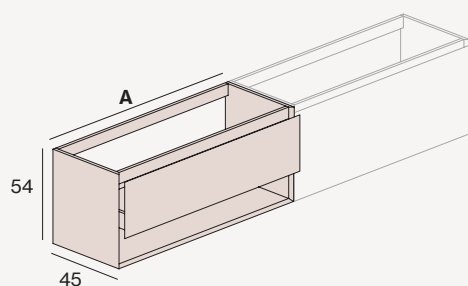

30	A203.030.M	-	-	-
40	A203.040.M	-	-	-
60	A203.060.M	-	-	-
70	A203.070.M	-	-	-
80	A203.080.M	-	-	-
90	A203.090.M	-	-	-
100	A203.100.M	-	-	-
120	A203.120.M	-	-	-
140	A203.140.M	-	-	-



·Puoi creare il tuo arredo personalizzato aggiungendo i moduli a destra e / o sinistra della base lavabo selezionata. Specifica la loro posizione.

**& complementi**

COMPLETA  
IL TUO MOBILE  
Organizzatori,  
portasciugamani, ...  
pagina 148



# Accessori per mobili da bagno **Atelier**

Interni dei mobili	150
Gambe del mobile	151
Esterni dei mobili	152

### INTERNI DEI MOBILI

#### ORGADRAW

Set divisori cassetti.



Antracite



**COD**

**PVP**

CM1

-

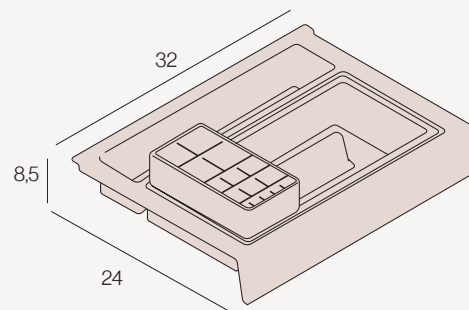

#### ORGASTRIP

Sistema di divisori a binari per cassetto superiore.

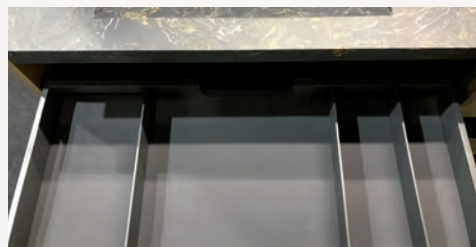

Antracite

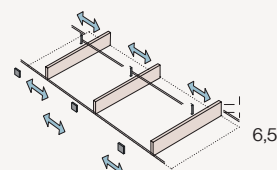

A	COD	DIVISORI	PVP
---	-----	----------	-----

30	CM2.030	1	-
40	CM2.040	1	-
60	CM2.060	2	-
70	CM2.070	2	-
80	CM2.080	3	-
90	CM2.090	3	-
100	CM2.100	4	-
120	CM2.120	4	-
140	CM2.140	4	-

#### Divisorio aggiuntivo

CM2.010	1	-
---------	---	---

#### PROTEZIONE CASSETTO

Strato protettivo antiscivolo per cassetti.



Colori

Perla

Terracotta



A	PERLA		TERRACOTTA	
	COD	PVP	COD	PVP

30	CM3.030	-	CM4.030	-
40	CM3.040	-	CM4.040	-
60	CM3.060	-	CM4.060	-
70	CM3.070	-	CM4.070	-
80	CM3.080	-	CM4.080	-
90	CM3.090	-	CM4.090	-
100	CM3.100	-	CM4.100	-
120	CM3.120	-	CM4.120	-
140	CM3.140	-	CM4.140	-

### GAMBE DEL MOBILE

#### STRUTTURA IN METALLO PER MOBILE H54

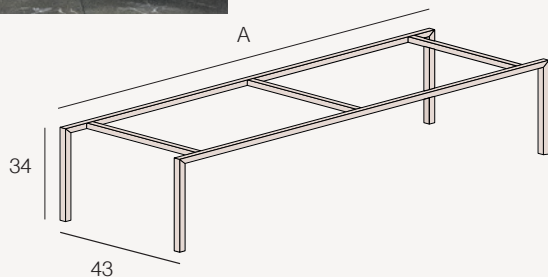

A	COD	NERO	COLORE
60	CM5.060	-	-
70	CM5.070	-	-
80	CM5.080	-	-
90	CM5.090	-	-
100	CM5.100	-	-
120	CM5.120	-	-
140	CM5.140	-	-
160	CM5.160	-	-
180	CM5.180	-	-
200	CM5.200	-	-

La misura del fondo della struttura e' approssimativamente di 2 cm inferiore rispetto al fondo del mobile per non interferire con i frontali.

#### Colori



#### GAMBE H3

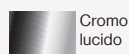
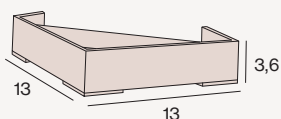

Cromo  
lucido

COD	PVP
CM6	-

Set di 4 unità'

#### GAMBE H7

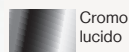
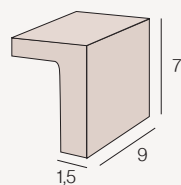

Cromo  
lucido

COD	PVP
CM7	-

Set di 4 unità'

### ESTERNO MOBILE

#### PORTASCIUGAMANI LATERALE

Portasalviette lucido da collocare nella parte laterale mobile.

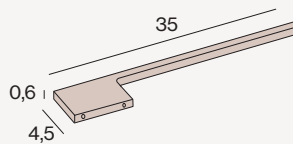

COLORE	COD	PVP
--------	-----	-----

Cromo lucido	CM8.CB	-
Nero opaco	CM8.BK	-
Colore RAL	CM8.CO	-

#### Colori



#### PORTASALVIETTE CON GAMBE

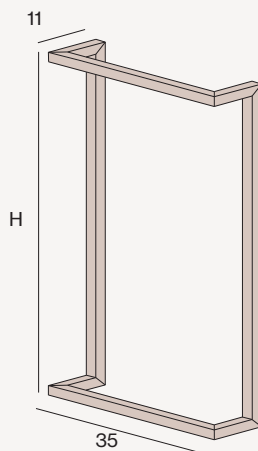

H	COLORE	COD	PVP
---	--------	-----	-----

75	Nero opaco	CM9.75.BK	-
75	Colore RAL	CM9.75.CO	-
85	Nero opaco	CM9.85.BK	-
85	Colore RAL	CM9.85.CO	-

H = 85 cm per mobili con lavabo integrato.

H = 75 cm per mobili con lavabo sopra piano.

#### Colori





### ESTERNO MOBILE

#### RETROILLUMINAZIONE INFERIORE MOBILE

Illuminazione parte inferiore del mobile.

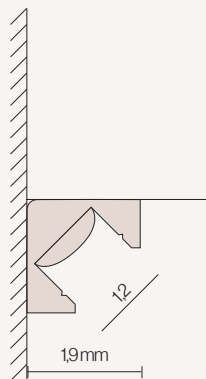

LUIZ	COLORE °K	CONSUMO	POTENZA	TENUTASTAGNA	DRIVER	MATERIALE
LED	4000°K Neutro	4,8W	400 LUMENS metro lineare	IP67	INCLUSO	ALUMINIO

Personalizza il tuo LED in 3000K o 4200K senza sovrapprezzo. Standard 5500 K.

#### STRISCIA AGGIUSTA PARETI

Striscia di regolazione tra le pareti.



A	COD	PVP
60	CM10.060	-
70	CM10.070	-
80	CM10.080	-
90	CM10.090	-
100	CM10.100	-
120	CM10.120	-
140	CM10.140	-
160	CM10.160	-
180	CM10.180	-
200	CM10.200	-

La misura reale dell'illuminazione a LED e' di 4 cm inferiore rispetto alla larghezza del mobile in modo che non si veda a lato.

H	COD	LACCA	PANNELLO MULTISTRATO MARINO
27	CM15.27	-	-
35	CM15.35	-	-
54	CM15.54	-	-
81	CM15.81	-	-

X da definire secondo necessita'.



# 02 Casual Arredo bagno

La tendenza, la freschezza, il quotidiano.

# Play

Libertà di comporre, modulare,  
colorare ogni progetto.





▲ Vasca  
*Orion Solid Surface*

Accessorio  
*Doppia scaffalatura  
metallica mensola*



339



333



Mobile  
2 cassettoni cassetto  
interno / Frontale  
maniglia Glass



Piano lavabo  
Integrato con rifinitura  
nero marquina



Specchio con cornice  
Specchio con bordo  
metallico mobile



Luce decorativa  
Ledarc





◀ Dettaglio frontale  
vetro con profilo  
metallico e puller  
integrato con vetro,  
strutturato nel colore  
carta laccata.





Specchio con cornice  
*Metalsquare*

Luce pendente  
*Ledarc*



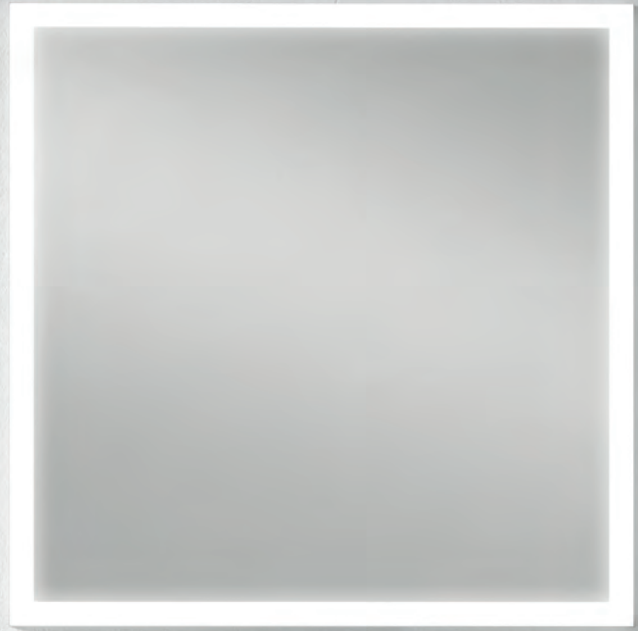



◀ Mobile

*1 cassettone con  
cassetto interno /  
frontale color vetro*



239

Piano lavabo  
*Piatto Ceramcolor  
Lavabo Ceramcolor  
Circus*



290

Specchio  
retroilluminato  
*Fronled*



304

Accessorio  
*Sgabello in metallo  
con sopra laccato*



335





- ▲ Lavabo in ceramica colorata con lo stesso colore dei mobili disponibili fino a 8 colori

- ◀ Vetrina frontale in vetro laccato testurizzato stesso colore tra i 18 colori di mobili a disposizione.

- ▼ Panca ausiliaria







◀ Mobile

*4 cassetti / maniglia  
Incolor finitura laccata  
Struttura metallica per  
gambe decorative*



241

Piano lavabo

*Solid Surface piana  
Lavabo da tavolo Cuadro  
in Solid Surface*



289

Specchio con cornice

*Corner personalizzato*



308

Luce decorativa

*Ledcirc*



321

Accessorio

*Armadio ausiliario due  
ante e decorativo*



331

Vasca

*Borealis Solid Surface*



338

Particolare interno del mobile. ►  
Cassetti in metallo 4D ad  
estrazione totale e frenata  
silenziosa. Il primo cassetto del  
lavabo con sifone distributore.

▼ Specchio angolare Mitra laccato









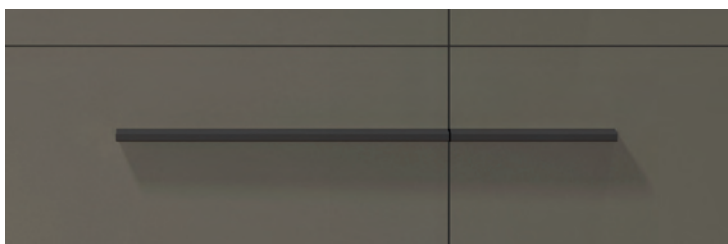
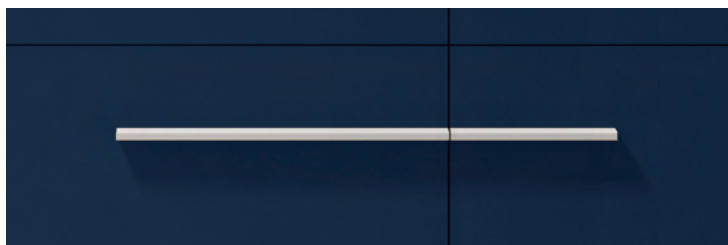
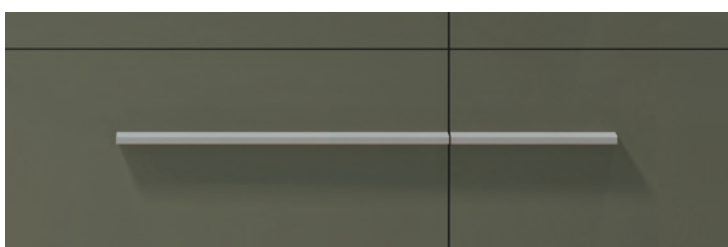

◀ Personalizza il tuo armadietto Incolore con uno qualsiasi tra i 18 colori della cartella laccature entrambi i mobili hanno la maniglia in alluminio laccato epossidico





- ◀ Mobile 📄 241  
*2 cassetti + cavo*  
*maniglia decorativa / Incolor*
  
- Piano lavabo 📄 288  
*Solid Mineral piatto*  
*Lavabo da appoggio Smile*
  
- Specchio liscio 📄 300  
*Rotondo liscio*
  
- Accessorio 📄 332  
*Ripiano in legno Complet*  
*portasciugamani da parete*  
*in metallo* 📄 334



239

**Mobile frontal ▶**

*2 cassette laccati / maniglia Black  
Porta asciugamano metallico  
com piedi*



306

**Specchio con cornice**  
*Metalsquareled*



321

**Luce decorativa**  
*Ledcirc*



330

**Accessori**

*Vetrina armadio 2 ante  
Panca ausiliaria*



335

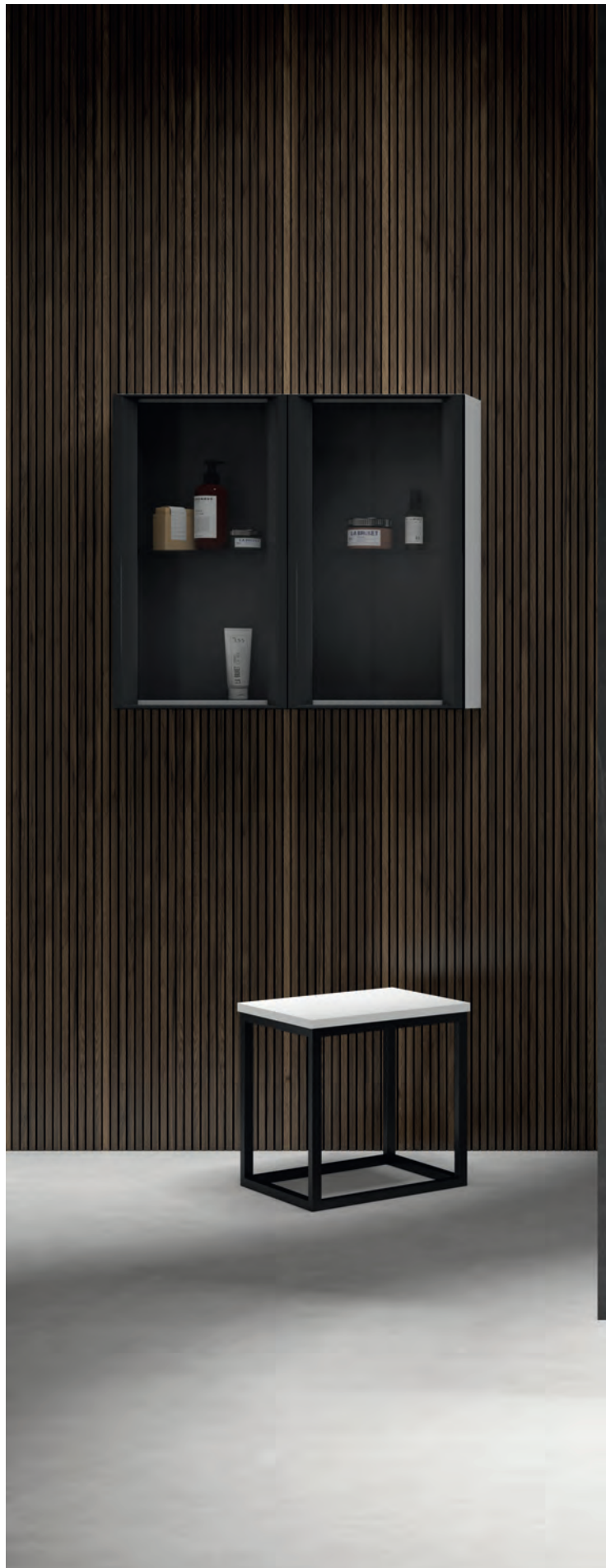



02 CASUAL  
MOBILIDA BAGNO

 244-245

Mobile  
Panca a 2 cassetti e modulo a  
1 cassetto Legno Nature / maniglia Negro

 284

Piano lavabo  
Plana con rivestimento in Legno  
Nature lavabo Circus Ceramcolor

 277

 306

Specchio con cornice  
Metalrounded







320

Luce decorativa  
*Ledpoint*



332

Complemento d'arredo  
*Mensola decorativa completato*



339

Vasca  
*Orion Solid Surface*



02 CASUAL  
MOBILI DA BAGNO



▲ Dettaglio maniglia nera



◀ Luce decorativa  
*Ledpoint*

Accessorio  
*Mensola decorativa  
Complet*



▲ Specchi con cornice in metallo  
con led integrato





▲ Complemento d'arredo  
*Pensile decorativa*





Mobile  
2 cassetti laccati / maniglia Curve  
Modulo decorativo laterale



Piano lavabo integrato  
Murale in ardesia



Specchio  
Eyeled



Accessorio  
Armadio ausiliario  
con decorativo 2 porte





◀ Specchio retroilluminato frontale Eyeled



▲ Dettaglio modulo decorativo laterale



Vasca ▶  
*Leo Solid Surface*







Mobile  
*Mobiletto 2 cassetti e 1 cassetto con  
foro decorativo / maniglia Lineal laccata*



Piano lavabo  
*Rovere massello piatto  
lavabo da appoggio in vetro*



Specchio retroilluminato ▲  
*Cerchiato*







▲ Piano lavabo in massello di rovere



▲ Dettaglio maniglia fresata Lineal

-  238 **Mobile** ▶  
*Panca laccata 2 cassetti /  
estrattore Inglete*
  
-  268 **Contro soffitti**  
*Parete integrata  
Solid Mineral personalizzato  
Top: piatto in Solid Mineral  
su misura*
  
-  302 **Specchio retroilluminato**  
*Filed*
  
-  321 **Luce decorativa**  
*Circled*
  
-  328 **Accessorio**  
*Pensile due ante  
laccata*





02 CASUAL  
MOBILI DA BAGNO

Complementi d'arredo ►  
*Pensile 2 ante / maniglia Push /  
banco ausiliario*

Vasca  
*Leo Solid Surface*



▲ Dettaglio della maniglia Mitra 45°









◀ Mobile

*1 cassetto / struttura  
laterale laccata e frontale  
Legno Nature / maniglia  
Rail / portasciugamani  
laterale laccato*



238

Piano lavabo integrato  
*Standard Solid Mineral*



264

Specchio  
*Liscio con LED 5X*



300-310

Accessorio  
*Porta asciugamani  
a muro*



334

Laccato  
*Applique per specchio  
Ledin*



318



▲ Vasca  
*Borealis*  
*Solid Surface*



Luce decorativa  
*Ledpoint*





**Mobile**  
2 cassetti e 1 anta / fianco  
Legno Nature e frontale  
laccato / maniglia Neo



**Piano lavabo integrato**  
Solid Mineral spostato  
a sinistra



**Specchio retroilluminato**  
Circled



**Accessorio**  
Armadio 1 anta  
supporto  
portasciugamani





◀ Portasciugamani da pavimento in metallo. A disposizione nei colori laccati



◀ Dettaglio cassetto top con distributore



◀ Dettaglio del tirante Neo



239



243



284



300



328



339



319

### Mobile ▶

*2 cassetti + struttura in metallo  
Legno Nature / maniglia Push*

### Piano lavabo

*legno naturale piano  
lavabo da appoggio  
color crema*

### Specchio

*liscio protetto su misura*

### Complementi d'arredo

*Composizione formata  
da pensile a 2 ante  
e 1 pensile porta laccato*

### Vasca

*Leo Solid Surface*

### Illuminazione

*Applique per specchio Ledbar*











- ▲ Le strutture metalliche possono essere personalizzate in uno qualsiasi tra i colori della cartella laccature

242

Mobile  
2 Cassettoni / Maniglia Line

285

Parte superiore piatta  
Laccato  
Lavabo solido minerale

303

Specchio retroilluminato  
Spinled





332



334



339



328



334





Accessori  
*Mensola decorativa Complet*  
*Portasciugamani da parete in metallo*

Vasca  
*Leo Solid Surface*







- ◀ Mobile  242  
*1 cassetto e 1 cassettone / maniglia*  
*Line finitura laccato*
  
- Parte superiore piatta  288  
*Solid Mineral*
  
- Lavabo  283  
*Totem in Solid Mieral*
  
- Specchio retroilluminato  303  
*Spinled*



◀ Mobile  
1 cassetto e 1 cassettone /  
maniglia Line finitura laccato

Parte superiore piatta  
Solid Mineral

Lavabo ▶  
Totem in Solid Surface  
Specchio retroilluminato  
Spinled





▲ Mobile  
 1 cassetto / maniglia Frame finitura  
 laccata / Struttura metallica con gambe  
 decorative con ripiano in vetro fumé



Piano lavabo integrato  
 Solid Mineral



Specchio liscio  
 Specchio con applique Ledbar







Luce decorativa  
*Ledcirc*



321

Vasca  
*Leo Solid Surface*



339

▼ Dettaglio cornice frontale



Vasca ►  
*Leo Solid Surface*  
Luce decorativa  
*Ledcirc*



▲ Struttura  
*Dettaglio struttura metallica in cristallo fume'*





▲ Mobile  
Struttura metallica gambe  
con ripiano in vetro fumé  
e portasciugamani

Piano lavabo integrato  
Solid Mineral Thin

Specchio retroilluminato  
Rounded



▲ Vasca  
*Borealis*

Accessorio  
*Porta asciugamani da terra  
in metallo*



# Step

Il cemento, appena in tempo.

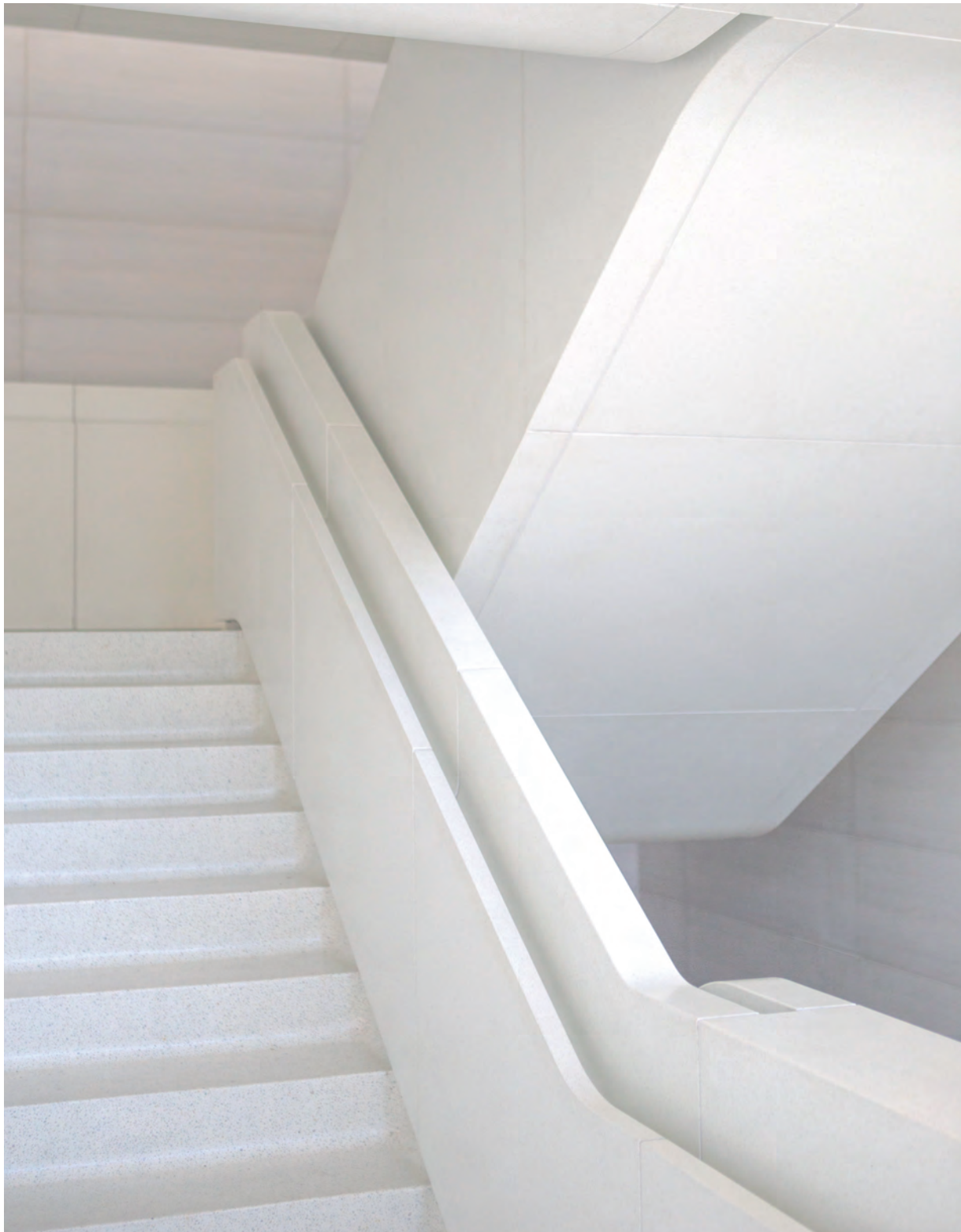

Vasca  
▼ *Borealis Solid Surface*

Accessorio  
*Portasciugamani da parete in metallo*







Mobile  
2 cassetti / maniglia Inglete  
Step finitura laccata



Piano lavabo integrato  
Ceramica



Specchio retroilluminato  
Rounded



02 CASUAL  
MOBILIDA BAGNO

Dettaglio ►  
frontale mitra







256

Mobile ▶

2 cassetti / maniglia Step  
con finitura laminato Sand



264

Piano lavabo integrato  
Solid Mineral



303

Specchio retroilluminato  
Spinled



335

Accessorio  
Porta asciugamani  
in metallo



338

Vasca  
Andrómeda Solid Surface







▲ Dettaglio della struttura in laminato





▲ Mobile  
2 cassetti / maniglia Inglete  
Step finitura laccata Blanco Opaco

Piano lavabo integrato  
Solid Mineral Hard doppia  
vasca

Specchio liscio  
Liscia / applique Ledin







Accessorio  
*Portasciugamani da parete in metallo*

Accessorio ►  
*Portasciugamani da parete  
in metallo*





▲ Dettaglio interno  
dei cassetti



STEP



# 02

## Informazioni tecniche e listino prezzi

# Casual

DECOSAN

Bath design

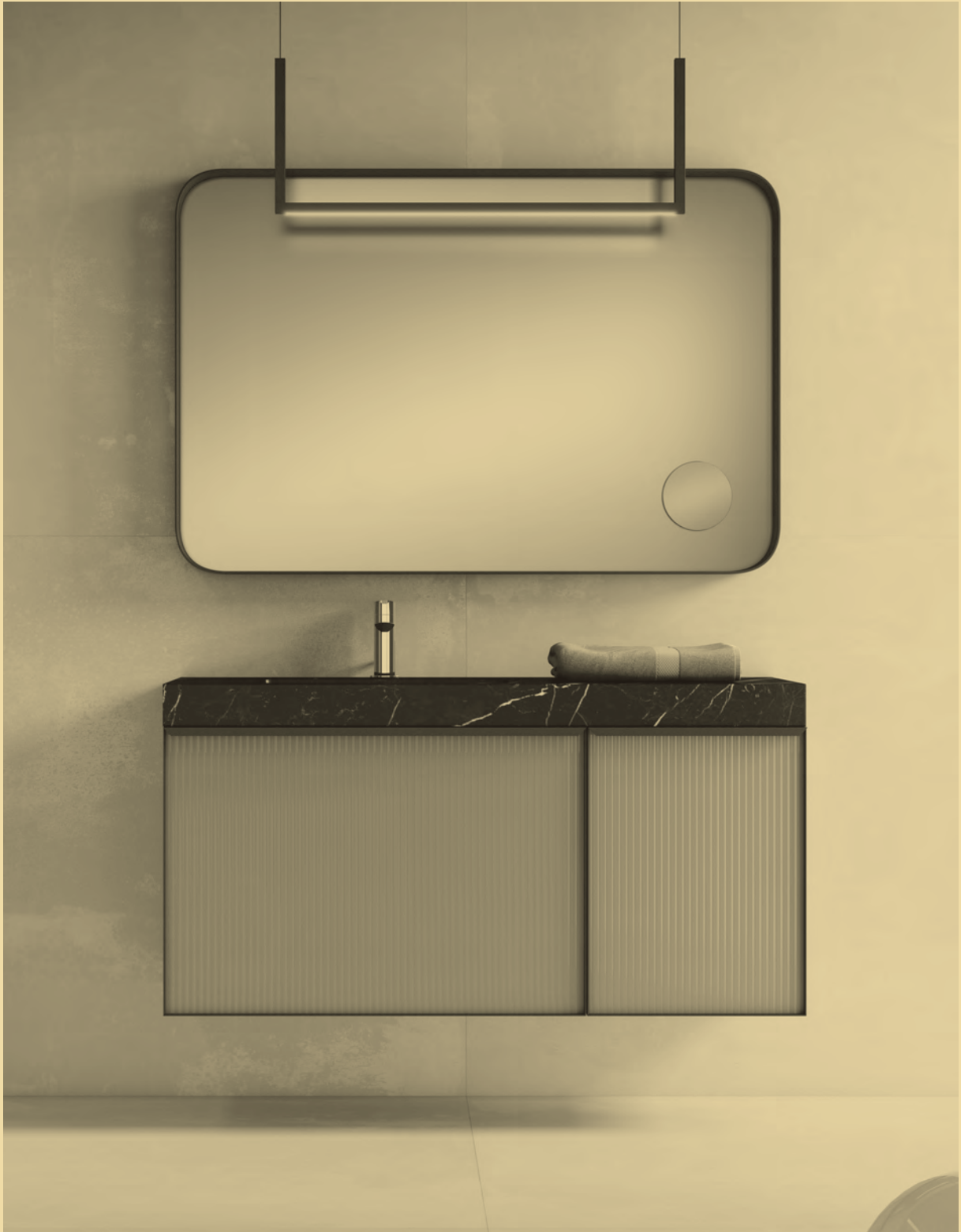

# Play

Caratteristiche e attrezzature	232
Personalizza i tuoi mobili Play	233
Basi lavabo sospese	238
Moduli sospesi	244
Play - Complementi	248



#### CASSETTI 4D

Cassetti in metallo Hettich o Blum colore antracite con profilo extra-sottile da 12 mm con 4 regolazioni. Le guide sono ad estrazione totale e impianto frenante progressivo.



#### SU MISURA

Questa collezione consente la produzione personalizzata. In caso di misure intermedie in altezza e larghezza prendere il prezzo della misura immediatamente più alta.



#### FULLCOLOR ANTRACITE

Idea di design d'interni per cui tutti i materiali degli interni dei mobili sono progettati in colore antracite. Il mobile con finitura laccata è internamente laccato antracite.



#### DURALACK SYSTEM

I colori laccati contengono additivi indurenti che permettono alla finitura finale di essere altamente resistente allo sfregamento e all'abrasione.



#### PUSH AND SLOW

I cassetti con il sistema di apertura senza maniglie "Push" hanno un sistema di sincronizzazione che permette loro di essere aperti premendo in qualsiasi punto del frontale. Allo stesso tempo, la chiusura è progressiva e silenziosa.



#### DECOFIX SYSTEM

Sistema di fissaggio a muro ad alta sicurezza con il quale le resistenze al carico sono maggiori di 240 kg.



#### DECOBUILD SYSTEM

Mobili realizzati con tavole da 19 mm incollate insieme ottenendo un'estetica pulita senza inserti visibili, offre una migliore resistenza e durezza.



Play ti consente di personalizzare facilmente i tuoi mobili

Scegli la maniglia, il colore e la struttura del mobile in soli due passaggi

- 1 Scegli la maniglia e specifica il colore desiderato
  - 1.1 Scegli la tua maniglia laccata
  - 1.2 Scegli la tua maniglia in legno
- 2 Scegli la struttura del mobile

**1.1** Scegli la tua maniglia Finitura laccata

**Black**

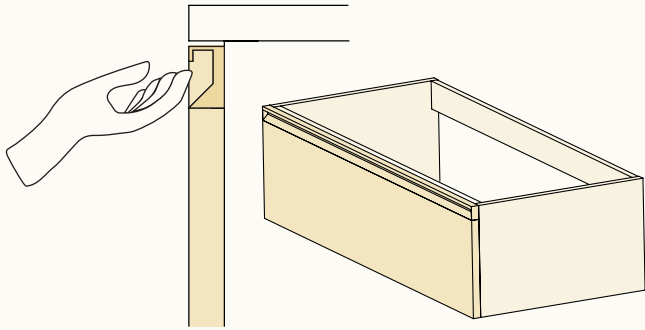

**Curve**

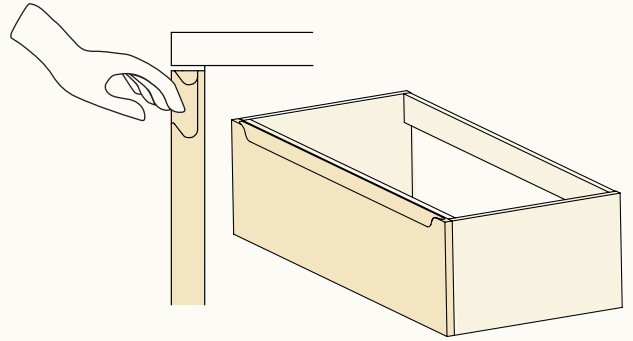

**Incolor**

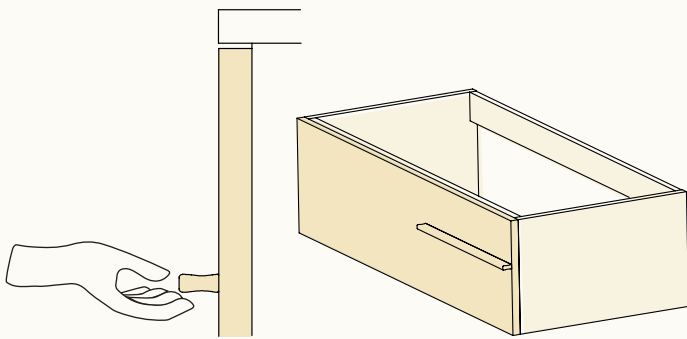

**Lineal**

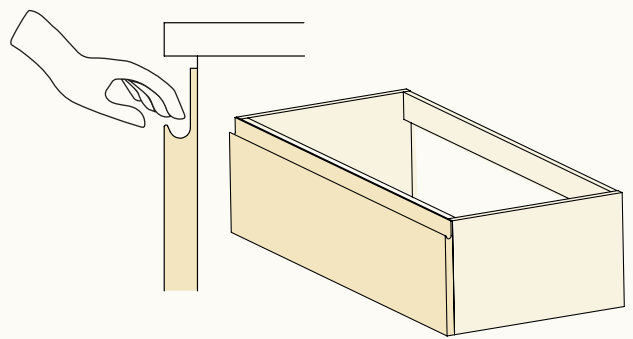

Si puo' scegliere il colore del cassetto diverso dal mobile

**Inglete**

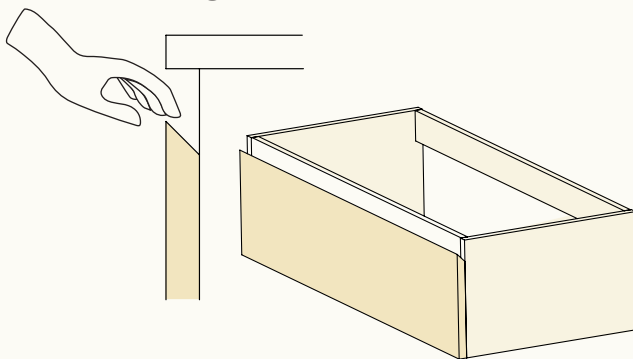

**Rail**

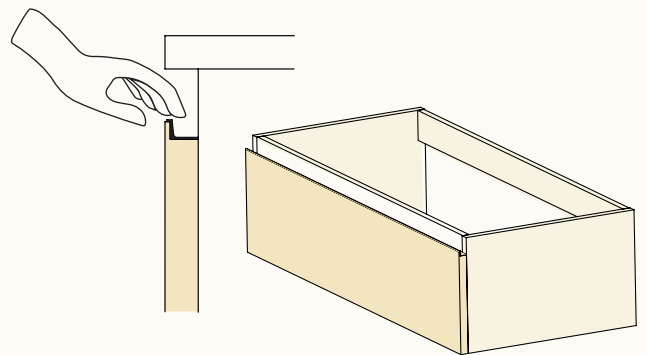

Profilo metallico in alluminio satinato

Blanco Opaco Blanco Lucido	Negro Opaco Negro Lucido	Beige Opaco Beige Lucido	Tierra Opaco Tierra Lucido	Caqui Opaco Caqui Lucido	Cuarzo Opaco Cuarzo Lucido	Moka Opaco Moka Lucido	Perla Opaco Perla Lucido	Piedra Opaco Piedra Lucido

### Neo

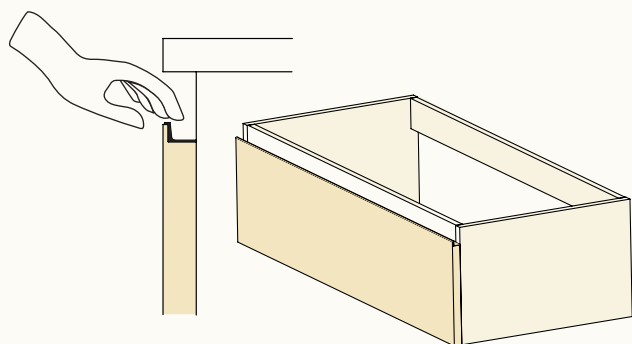

Profilo metallico nero opaco

### Push

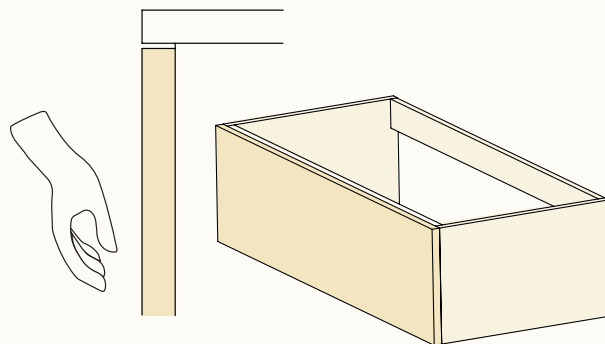

### Line

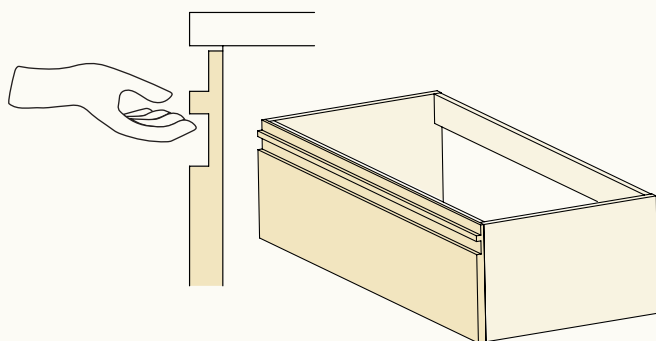

### Frame

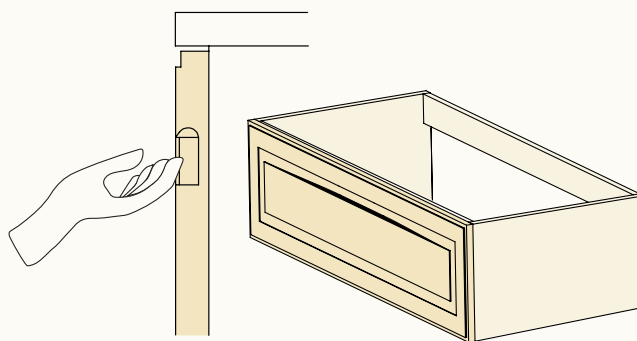

### Glass

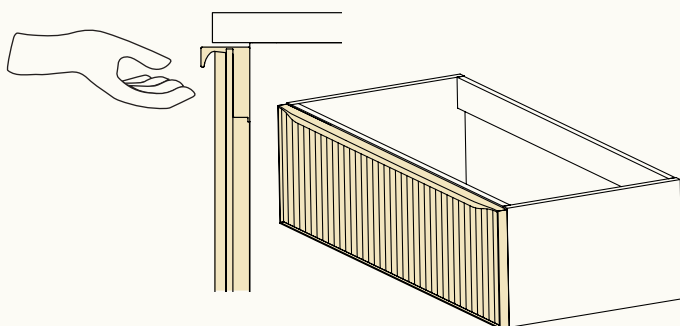

Profilo nero  
Si puo' scegliere il colore del cristallo diverso dal mobile



Colori RAL ó NCS

RAL / NCS Opaco

RAL / NCS Lucido

Acero Opaco  
Acero Lucido

Antracita Opaco  
Antracita Lucido

Burdeos Opaco  
Burdeos Lucido

Océano Opaco  
Océano Lucido

Menta Opaco  
Menta Lucido

Oliva Opaco  
Oliva Lucido

Terracota Opaco  
Terracota Lucido

Albero Opaco  
Albero Lucido

Rosa Opaco  
Rosa Lucido



**1.2** Scegli il tuo manico in legno Finitura Legno Nature

**Black**

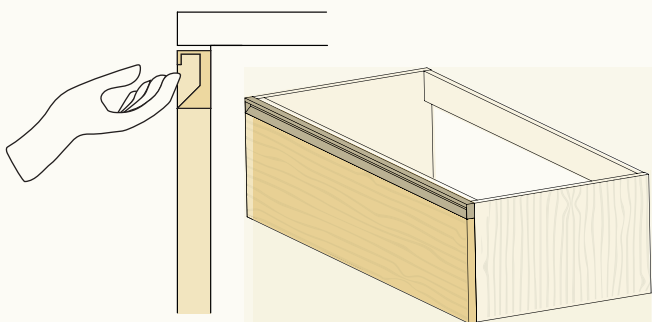

**Push**

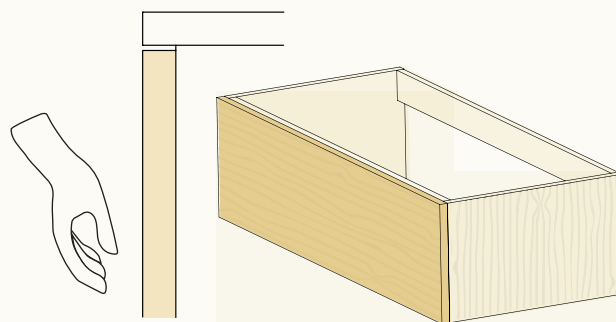

**Incolor**

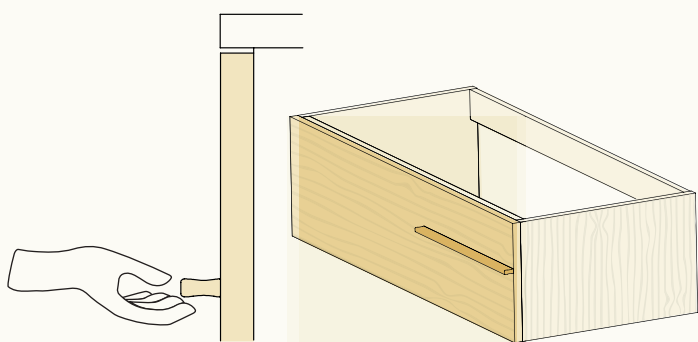

**Rail**

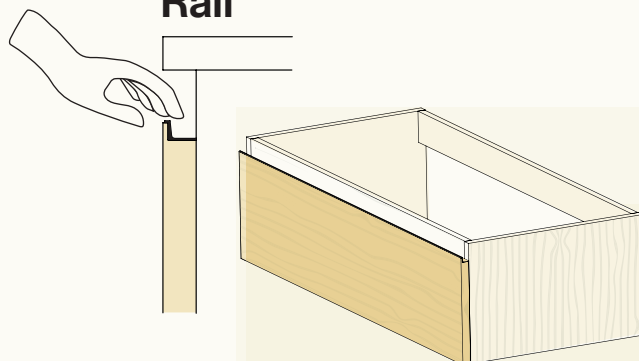

Scegli il colore del cassetto (finitura lucida o mate)

Profilo metallico alluminio satinato

**Neo**

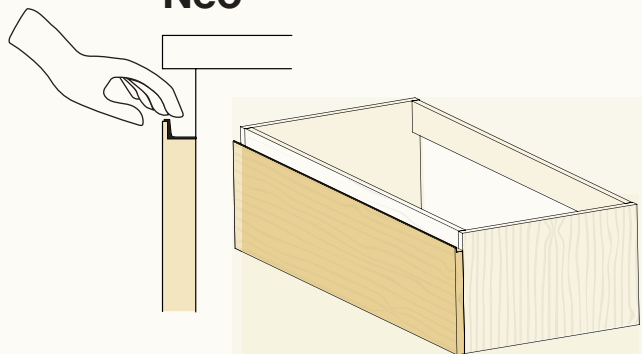

Profilo metallico nero opaco

Carbon



Brown

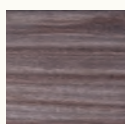

Artic

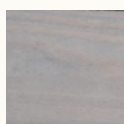

Cocoa

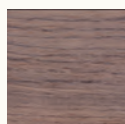

Camel

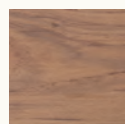

Savana

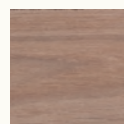

Noce

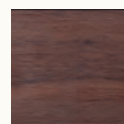

## 2 Scegli la struttura del mobile

In tutte le configurazioni puoi scegliere due differenti opzioni per la struttura

### Frontale

La maniglia si sovrappone alla struttura del mobile.

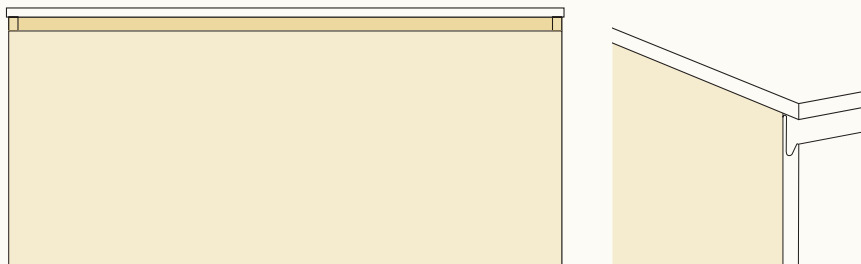

### Lato

I lati del mobile sono visti come un terminale decorativo.

- Particolarmente consigliato nei casi in cui i mobili sono attaccati ad un muro.
- In caso di demodulazione di più basi saranno visibili solo le estremità della composizione.

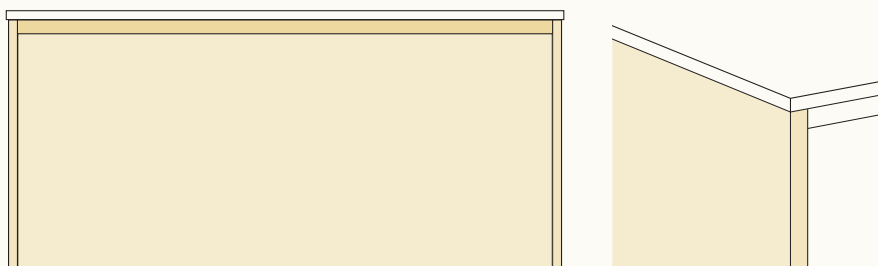

Nello standard il colore della struttura è uguale al colore della maniglia

Se si desidera si può scegliere il colore della struttura differente a quello della maniglia.

Blanco Opaco Blanco Lucido	Negro Opaco Negro Lucido	Beige Opaco Beige Lucido	Tierra Opaco Tierra Lucido	Caqui Opaco Caqui Lucido	Cuarzo Opaco Cuarzo Lucido	Moka Opaco Moka Lucido	Perla Opaco Perla Lucido	Piedra Opaco Piedra Lucido
Acero Opaco Acero Lucido	Antracita Opaco Antracita Lucido	Burdeos Opaco Burdeos Lucido	Océano Opaco Océano Lucido	Menta Opaco Menta Lucido	Oliva Opaco Oliva Lucido	Terracota Opaco Terracota Lucido	Albero Opaco Albero Lucido	Rosa Opaco Rosa Lucido
Carbon	Brown	Artic	Cocoa	Camel	Savana	Noce		

### BASI PER LAVABO SOSPESO

#### 1 CASSETTO

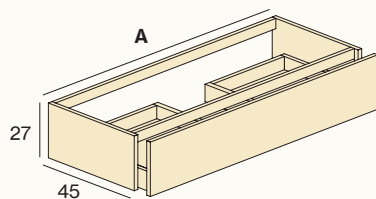

A (cm)	LAVABO	COD	LEGNO NATURE		LACCA	
			BLACK-INCOLOR-NEO-RAIL	PUSH	BLACK-CURVE-LINEAL-INCOLOR-INGLETE-NEO-RAIL	LINE-GLASS-FRAME-PUSH
60		P101.060.C	-	-	-	-
70		P101.070.C	-	-	-	-
80		P101.080.C	-	-	-	-
90		P101.090.C	-	-	-	-
100		P101.100.I	-	-	-	-
100		P101.100.C	-	-	-	-
100		P101.100.D	-	-	-	-
120		P101.120.I	-	-	-	-
120		P101.120.C	-	-	-	-
120		P101.120.D	-	-	-	-
120		P101.120.X	-	-	-	-
140		P101.140.I	-	-	-	-
140		P101.140.C	-	-	-	-
140		P101.140.D	-	-	-	-
140		P101.140.X	-	-	-	-

#### 2 CASSETTI ASIMMETRICI

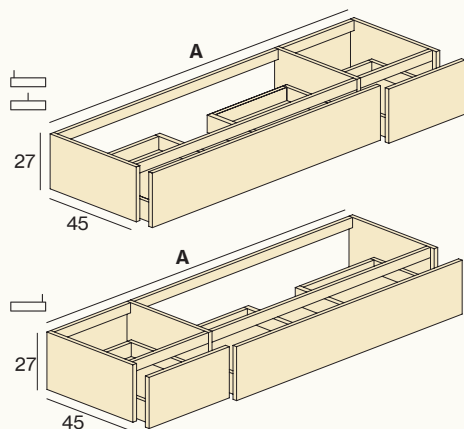

120		P102.120.I	-	-	-	-
120		P102.120.C	-	-	-	-
120		P102.120.D	-	-	-	-
140		P102.140.I	-	-	-	-
140		P102.140.C	-	-	-	-
140		P102.140.D	-	-	-	-
160		P102.160.I	-	-	-	-
160		P102.160.C	-	-	-	-
160		P102.160.D	-	-	-	-
180		P102.180.I	-	-	-	-
180		P102.180.C	-	-	-	-
180		P102.180.D	-	-	-	-
200		P102.200.I	-	-	-	-
200		P102.200.C	-	-	-	-
200		P102.200.D	-	-	-	-

#### 2 CASSETTI SIMMETRICI

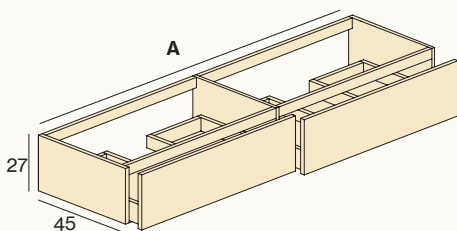

120		P103.120.I	-	-	-	-
120		P103.120.D	-	-	-	-
120		P103.120.X	-	-	-	-
140		P103.140.I	-	-	-	-
140		P103.140.D	-	-	-	-
140		P103.140.X	-	-	-	-
160		P103.160.I	-	-	-	-
160		P103.160.D	-	-	-	-
160		P103.160.X	-	-	-	-
180		P103.180.I	-	-	-	-
180		P103.180.D	-	-	-	-
180		P103.180.X	-	-	-	-
200		P103.200.I	-	-	-	-
200		P103.200.D	-	-	-	-
200		P103.200.X	-	-	-	-



- Le composizioni asimmetriche hanno la seguente modulazione: 120 (80 + 40), 140 (80 + 60), 160 (100 + 60), 180 (120 + 60), 200 (120 + 80). Altre configurazioni disponibili
- Mobili speciali: per misure intermedie in larghezza e / o altezza, prendere il prezzo della misura immediatamente superiore.

#### & complementi

Organizzatori, gambe, porta asciugamani, retroilluminazione pagina.....248

- C Lavabo centrato
- D Lavabo destro
- I Lavabo sinistro
- X Doppio lavabo

BASI PER LAVABO SOSPESO

2 CASSETTI

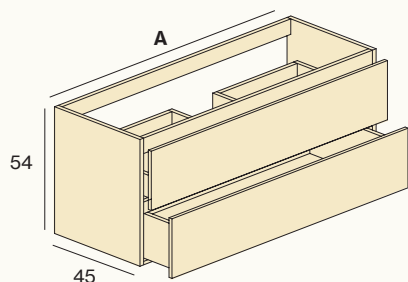

A (cm)	LAVABO	COD	LEGNO NATURE		LACCA	
			BLACK-INCOLOR-NEO-RAIL	PUSH	BLACK-CURVE-LINEAL-INCOLOR-INGLETE-NEO-RAIL	LINE-GLASS-FRAME-PUSH
60		P201.060.C	-	-	-	-
70		P201.070.C	-	-	-	-
80		P201.080.C	-	-	-	-
90		P201.090.C	-	-	-	-
100		P201.100.I	-	-	-	-
100		P201.100.C	-	-	-	-
100		P201.100.D	-	-	-	-
120		P201.120.I	-	-	-	-
120		P201.120.C	-	-	-	-
120		P201.120.D	-	-	-	-
120		P201.120.X	-	-	-	-
140		P201.140.I	-	-	-	-
140		P201.140.C	-	-	-	-
140		P201.140.D	-	-	-	-
140		P201.140.X	-	-	-	-

1 CASSETTONE

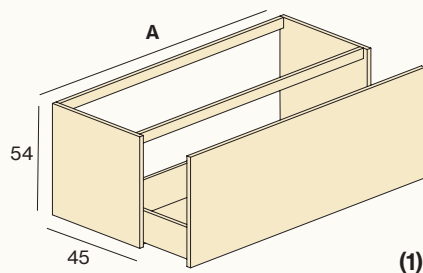

60		P202.060.C	-	-	-	-
70		P202.070.C	-	-	-	-
80		P202.080.C	-	-	-	-
90		P202.090.C	-	-	-	-
100		P202.100.I	-	-	-	-
100		P202.100.C	-	-	-	-
100		P202.100.D	-	-	-	-
120		P202.120.I	-	-	-	-
120		P202.120.C	-	-	-	-
120		P202.120.D	-	-	-	-
120		P202.120.X	-	-	-	-
140		P202.140.I	-	ND	-	-
140		P202.140.C	-	ND	-	-
140		P202.140.D	-	ND	-	-
140		P202.140.X	-	ND	-	-

· Larghezza 140 cm non disponibile per la spinta anteriore

1 CASSETTO + DECORATIVO

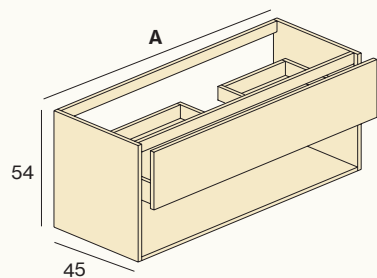

60		P203.060.C	-	-	-	-
70		P203.070.C	-	-	-	-
80		P203.080.C	-	-	-	-
90		P203.090.C	-	-	-	-
100		P203.100.I	-	-	-	-
100		P203.100.C	-	-	-	-
100		P203.100.D	-	-	-	-
120		P203.120.I	-	-	-	-
120		P203.120.C	-	-	-	-
120		P203.120.D	-	-	-	-
120		P203.120.X	-	-	-	-
140		P203.140.I	-	-	-	-
140		P203.140.C	-	-	-	-
140		P203.140.D	-	-	-	-
140		P203.140.X	-	-	-	-

(1) CASSETTO INTERNO

Nel cassetto interno può essere inserita la composizione con il cassettone

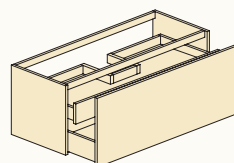

A (cm)	COD	PVP
40	P220.040	-
60	P220.060	-
70	P220.070	-
80	P220.080	-
90	P220.090	-
100	P220.100	-
120	P220.120	-
120X	P220.120X	-
140	P220.140	-
140X	P220.140X	-

### BASI PER LAVABO SOSPESO

#### 2 CASSETTI + ANTA

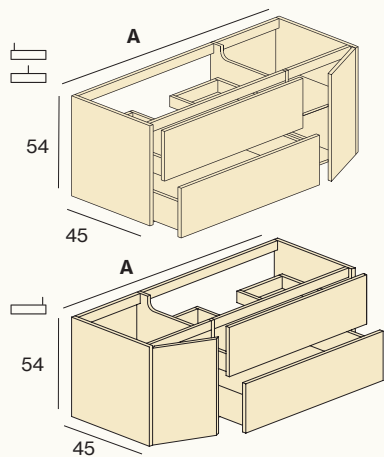

A (cm)	LAVABO	COD	LEGNO NATURE		LACCA	
			BLACK-INCOLOR-NEO-RAIL	PUSH	BLACK-CURVE-LINEAL-INCOLOR-INGLETE-NEO-RAIL	LINE-GLASS-FRAME-PUSH
120		P204.120.I	-	-	-	-
120		P204.120.C	-	-	-	-
120		P204.120.D	-	-	-	-
140		P204.140.I	-	-	-	-
140		P204.140.C	-	-	-	-
140		P204.140.D	-	-	-	-
160		P204.160.I	-	-	-	-
160		P204.160.C	-	-	-	-
160		P204.160.D	-	-	-	-
180		P204.180.I	-	-	-	-
180		P204.180.C	-	-	-	-
180		P204.180.D	-	-	-	-

#### CASSETTONE + 2 CASSETTI ASIMMETRICI

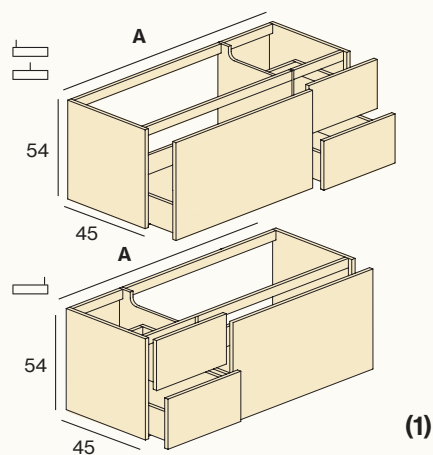

120		P205.120.I	-	-	-	-
120		P205.120.C	-	-	-	-
120		P205.120.D	-	-	-	-
140		P205.140.I	-	-	-	-
140		P205.140.C	-	-	-	-
140		P205.140.D	-	-	-	-
160		P205.160.I	-	-	-	-
160		P205.160.C	-	-	-	-
160		P205.160.D	-	-	-	-
180		P205.180.I	-	-	-	-
180		P205.180.C	-	-	-	-
180		P205.180.D	-	-	-	-
200		P205.200.I	-	-	-	-
200		P205.200.C	-	-	-	-
200		P205.200.D	-	-	-	-

#### CASSETTONE + 2 CASSETTI SIMMETRICI

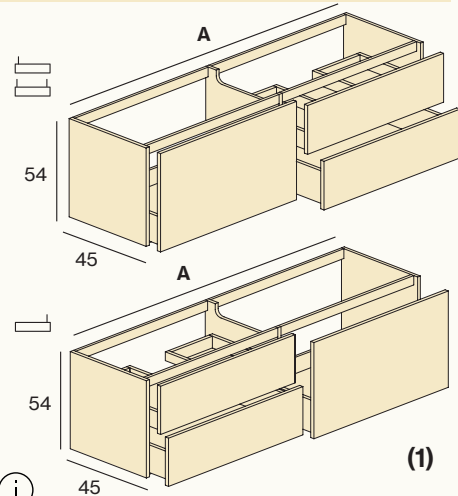

120		P206.120.I	-	-	-	-
120		P206.120.D	-	-	-	-
120		P206.120.X	-	-	-	-
140		P206.140.I	-	-	-	-
140		P206.140.D	-	-	-	-
140		P206.140.X	-	-	-	-
160		P206.160.I	-	-	-	-
160		P206.160.D	-	-	-	-
160		P206.160.X	-	-	-	-
180		P206.180.I	-	-	-	-
180		P206.180.D	-	-	-	-
180		P206.180.X	-	-	-	-
200		P206.200.I	-	-	-	-
200		P206.200.D	-	-	-	-
200		P206.200.X	-	-	-	-

- Le composizioni asimmetriche hanno la seguente modulazione: 120 (80 + 40), 140 (80 + 60), 160 (100 + 60), 180 (120 + 60), 200 (120 + 80). Altre configurazioni disponibili
- Mobili speciali: per misure intermedie in larghezza e / o altezza, prendere il prezzo della misura immediatamente superiore.

#### & complementi

Organizzatori, gambe, porta asciugamani, retroilluminazione pagina.....248

- C Lavabo centrato
- D Lavabo destro
- I Lavabo sinistro
- X Doppio lavabo



BASI PER LAVABO SOSPESO

4 CASSETTI ASIMMETRICI

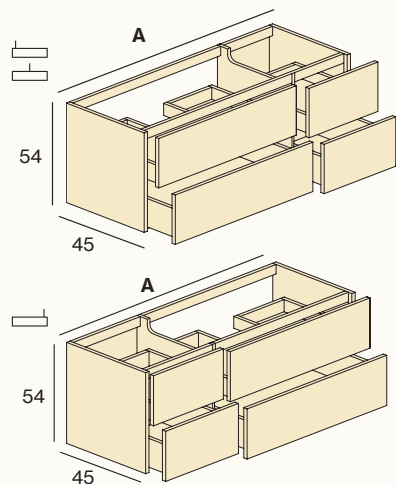

A (cm)	LAVABO	COD	LEGNO NATURE		LACCA	
			BLACK-INCOLOR-NEO-RAIL	PUSH	BLACK-CURVE-LINEAL-INCOLOR-INGLETE-NEO-RAIL	LINE-GLASS-FRAME-PUSH
120		P208.120.I	-	-	-	-
120		P208.120.C	-	-	-	-
120		P208.120.D	-	-	-	-
140		P208.140.I	-	-	-	-
140		P208.140.C	-	-	-	-
140		P208.140.D	-	-	-	-
160		P208.160.I	-	-	-	-
160		P208.160.C	-	-	-	-
160		P208.160.D	-	-	-	-
180		P208.180.I	-	-	-	-
180		P208.180.C	-	-	-	-
180		P208.180.D	-	-	-	-
200		P208.200.I	-	-	-	-
200		P208.200.C	-	-	-	-
200		P208.200.D	-	-	-	-

4 CASSETTI SIMMETRICI

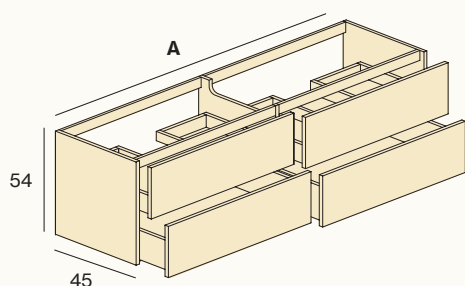

120		P209.120.I	-	-	-	-
120		P209.120.D	-	-	-	-
120		P209.120.X	-	-	-	-
140		P209.140.I	-	-	-	-
140		P209.140.D	-	-	-	-
140		P209.140.X	-	-	-	-
160		P209.160.I	-	-	-	-
160		P209.160.D	-	-	-	-
160		P209.160.X	-	-	-	-
180		P209.180.I	-	-	-	-
180		P209.180.D	-	-	-	-
180		P209.180.X	-	-	-	-
200		P209.200.I	-	-	-	-
200		P209.200.D	-	-	-	-
200		P209.200.X	-	-	-	-

2 CASSETTI + DECORATIVO

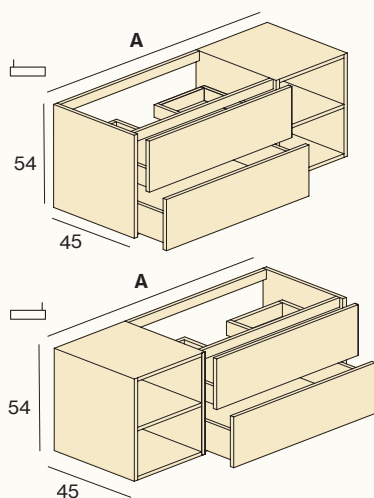

120		P207.120.I	-	-	-	-
120		P207.120.D	-	-	-	-
140		P207.140.I	-	-	-	-
140		P207.140.D	-	-	-	-
160		P207.160.I	-	-	-	-
160		P207.160.D	-	-	-	-
180		P207.180.I	-	-	-	-
180		P207.180.D	-	-	-	-

(1) CASSETTO INTERNO

Nel cassetto interno può essere inserita la composizione con il cassettone

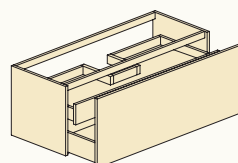

A (cm)	COD	PVP
40	P220.040	-
60	P220.060	-
70	P220.070	-
80	P220.080	-
90	P220.090	-
100	P220.100	-
120	P220.120	-
120X	P220.120X	-
140	P220.140	-
140X	P220.140X	-

### BASI PER LAVABO SOSPESO

#### 2 CASSETTONI ASIMMETRICI

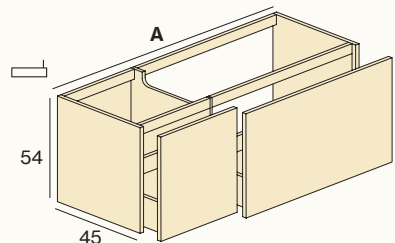
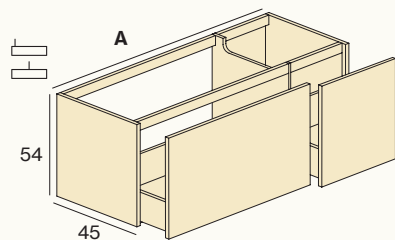

(1)

#### 2 CASSETTONI SIMMETRICI

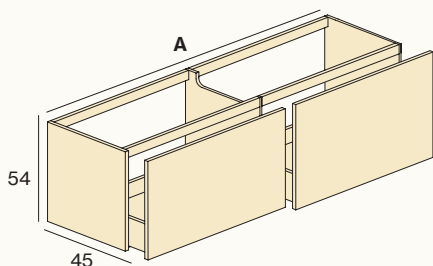

(1)

#### 1 CASSETTO + 1 CASSETTONE

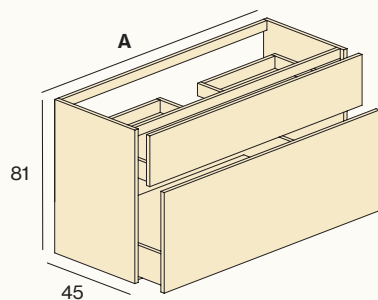

(1)

A (cm)	LAVABO	COD	LEGNO NATURE		LACCA	
			BLACK-INCOLOR-NEO-RAIL	PUSH	BLACK-CURVE-LINEAL-INCOLOR-INGLETE-NEO-RAIL	LINE-GLASS-FRAME-PUSH
120		P210.120.I	-	-	-	-
120		P210.120.C	-	-	-	-
120		P210.120.D	-	-	-	-
140		P210.140.I	-	-	-	-
140		P210.140.C	-	-	-	-
140		P210.140.D	-	-	-	-
160		P210.160.I	-	-	-	-
160		P210.160.C	-	-	-	-
160		P210.160.D	-	-	-	-
180		P210.180.I	-	-	-	-
180		P210.180.C	-	-	-	-
180		P210.180.D	-	-	-	-
200		P210.200.I	-	-	-	-
200		P210.200.C	-	-	-	-
200		P210.200.D	-	-	-	-

120		P211.120.I	-	-	-	-
120		P211.120.D	-	-	-	-
120		P211.120.X	-	-	-	-
140		P211.140.I	-	-	-	-
140		P211.140.D	-	-	-	-
140		P211.140.X	-	-	-	-
160		P211.160.I	-	-	-	-
160		P211.160.D	-	-	-	-
160		P211.160.X	-	-	-	-
180		P211.180.I	-	-	-	-
180		P211.180.D	-	-	-	-
180		P211.180.X	-	-	-	-
200		P211.200.I	-	-	-	-
200		P211.200.D	-	-	-	-
200		P211.200.X	-	-	-	-

60		P312.060.C	-	-	-	-
70		P312.070.C	-	-	-	-
80		P312.080.C	-	-	-	-
90		P312.090.C	-	-	-	-
100		P312.100.I	-	-	-	-
100		P312.100.C	-	-	-	-
100		P312.100.D	-	-	-	-
120		P312.120.I	-	-	-	-
120		P312.120.C	-	-	-	-
120		P312.120.D	-	-	-	-



- Le composizioni asimmetriche hanno la seguente modulazione: 120 (80 + 40), 140 (80 + 60), 160 (100 + 60), 180 (120 + 60), 200 (120 + 80). Altre configurazioni disponibili
- Mobili speciali: per misure intermedie in larghezza e / o altezza, prendere il prezzo della misura immediatamente superiore.

#### & complementi

Organizzatori, gambe, porta asciugamani, retroilluminazione pagina.....248

- C Lavabo centrato
- D Lavabo destro
- I Lavabo sinistro
- X Doppio lavabo

BASI PER LAVABO SOSPESO

3 CASSETTI

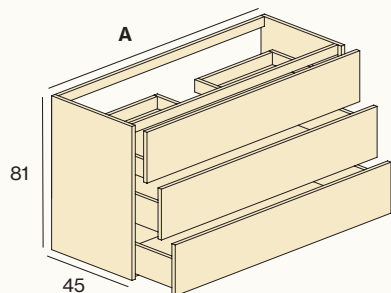

A (cm)	LAVABO	COD	LEGNO NATURE		LACCA	
			BLACK-INCOLOR-NEO-RAIL	PUSH	BLACK-CURVE-LINEAL-INCOLOR-INGLETE-NEO-RAIL	LINE-GLASS-FRAME-PUSH
60		P313.060.C	-	-	-	-
70		P313.070.C	-	-	-	-
80		P313.080.C	-	-	-	-
90		P313.090.C	-	-	-	-
100		P313.100.I	-	-	-	-
100		P313.100.C	-	-	-	-
100		P313.100.D	-	-	-	-
120		P313.120.I	-	-	-	-
120		P313.120.C	-	-	-	-
120		P313.120.D	-	-	-	-

BASE MOBILE SOSPESO

STRUTTURA METALLICA SOSPESA

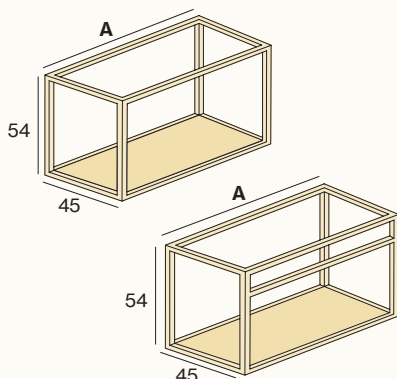

A (cm)	COD	NEGRO			COLORE		
		LEGNO NATURE	LACCA	CRISTALLO FUMÉ	LEGNO NATURE	LACCA	CRISTALLO FUMÉ
60	P214.060.C	-	-	-	-	-	-
70	P214.070.C	-	-	-	-	-	-
80	P214.080.C	-	-	-	-	-	-
90	P214.090.C	-	-	-	-	-	-
100	P214.100.C	-	-	-	-	-	-
120	P214.120.C	-	-	-	-	-	-
140	P214.140.C	-	-	-	-	-	-
60	P216.060.C	-	-	-	-	-	-
70	P216.070.C	-	-	-	-	-	-
80	P216.080.C	-	-	-	-	-	-
90	P216.090.C	-	-	-	-	-	-
100	P216.100.C	-	-	-	-	-	-
120	P216.120.C	-	-	-	-	-	-
140	P216.140.C	-	-	-	-	-	-

STRUTTURA METALLICA A PAVIMENTO

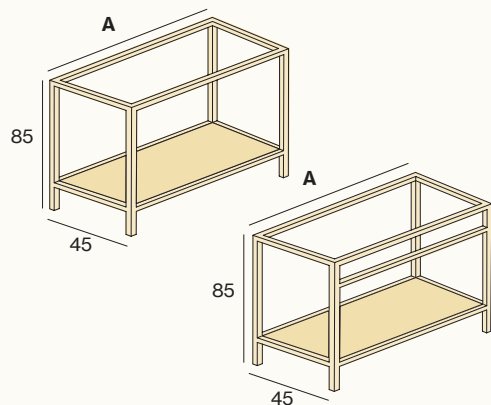

60	P215.060.C	-	-	-	-	-	-
70	P215.070.C	-	-	-	-	-	-
80	P215.080.C	-	-	-	-	-	-
90	P215.090.C	-	-	-	-	-	-
100	P215.100.C	-	-	-	-	-	-
120	P215.120.C	-	-	-	-	-	-
140	P215.140.C	-	-	-	-	-	-
60	P217.060.C	-	-	-	-	-	-
70	P217.070.C	-	-	-	-	-	-
80	P217.080.C	-	-	-	-	-	-
90	P217.090.C	-	-	-	-	-	-
100	P217.100.C	-	-	-	-	-	-
120	P217.120.C	-	-	-	-	-	-
140	P217.140.C	-	-	-	-	-	-

(1) CASSETTO INTERNO

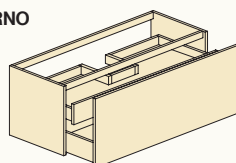

Nel cassetto interno può essere inserita la composizione con il cassettone

A (cm)	COD	PVP
40	P220.040	-
60	P220.060	-
70	P220.070	-
80	P220.080	-
90	P220.090	-
100	P220.100	-
120	P220.120	-
120X	P220.120X	-
140	P220.140	-
140X	P220.140X	-

### MODULI SOSPESI

#### 1 CASSETTO

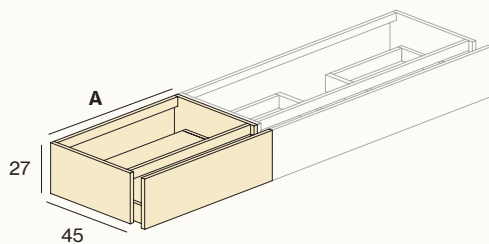

A (cm)	COD	LEGNO NATURE		LACCA	
		BLACK-INCOLOR-NEO-RAIL	PUSH	BLACK-CURVE-LINEAL-INCOLOR-INGLETE-NEO-RAIL	LINE-GLASS-FRAME-PUSH
30	P101.030.M	-	-	-	-
40	P101.040.M	-	-	-	-
60	P101.060.M	-	-	-	-
70	P101.070.M	-	-	-	-
80	P101.080.M	-	-	-	-
90	P101.090.M	-	-	-	-
100	P101.100.M	-	-	-	-
120	P101.120.M	-	-	-	-
140	P101.140.M	-	-	-	-

#### 2 CASSETTI

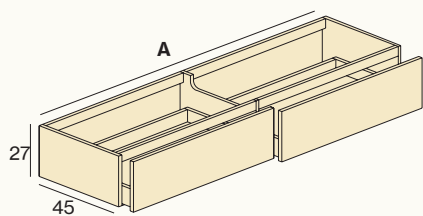

120	P103.120.M	-	-	-	-
140	P103.140.M	-	-	-	-
160	P103.160.M	-	-	-	-
180	P103.180.M	-	-	-	-
200	P103.200.M	-	-	-	-

#### DECORATIVO

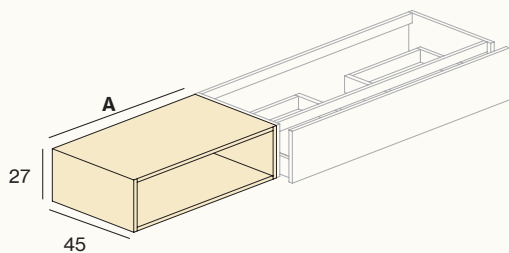

30	P104.030.M	-	-	-	-
40	P104.040.M	-	-	-	-
60	P104.060.M	-	-	-	-
70	P104.070.M	-	-	-	-
80	P104.080.M	-	-	-	-



·Puoi creare il tuo arredo personalizzato aggiungendo i moduli a destra e / o sinistra della base lavabo selezionata.  
Specifica la loro posizione.

MODULI SOSPESI

1 ANTA

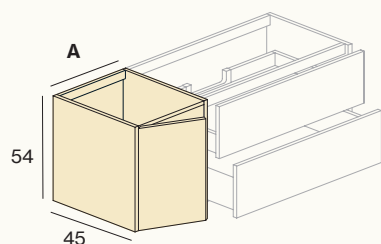

A (cm)	ANTA	COD	LEGNO NATURE		LACCA	
			BLACK-INCOLOR-NEO-RAIL	PUSH	BLACK-CURVE-LINEAL-INCOLOR-INGLETE-NEO-RAIL	LINE-GLASS-FRAME-PUSH
30		P204.030.MI	-	-	-	-
30		P204.030.MD	-	-	-	-
40		P204.040.MI	-	-	-	-
40		P204.040.MD	-	-	-	-

2 CASSETTI

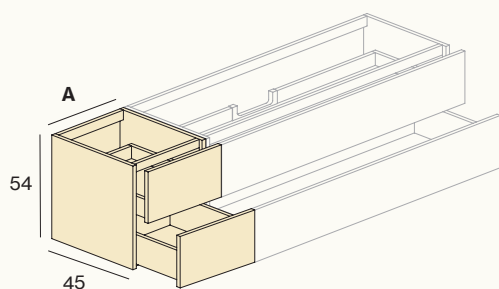

A (cm)	COD	LEGNO NATURE		LACCA	
		BLACK-INCOLOR-NEO-RAIL	PUSH	BLACK-CURVE-LINEAL-INCOLOR-INGLETE-NEO-RAIL	LINE-GLASS-FRAME-PUSH
30	P201.030.M	-	-	-	-
40	P201.040.M	-	-	-	-
60	P201.060.M	-	-	-	-
70	P201.070.M	-	-	-	-
80	P201.080.M	-	-	-	-
90	P201.090.M	-	-	-	-
100	P201.100.M	-	-	-	-
120	P201.120.M	-	-	-	-
140	P201.140.M	-	-	-	-

1 CASSETTONE

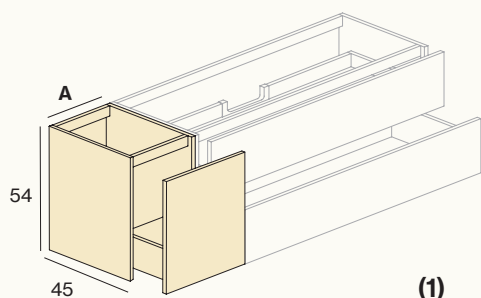

30	P202.030.M	-	-	-	-
40	P202.040.M	-	-	-	-
60	P202.060.M	-	-	-	-
70	P202.070.M	-	-	-	-
80	P202.080.M	-	-	-	-
90	P202.090.M	-	-	-	-
100	P202.100.M	-	-	-	-
120	P202.120.M	-	-	-	-
140	P202.140.M	-	ND	-	-

· Per larghezza 140 cm non disponibile a spinta anteriore.

(1) CASSETTO INTERNO

Nel cassetto interno può essere inserita la composizione con il cassettone

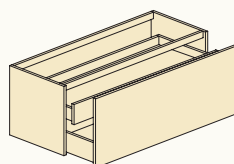

A (cm)	COD	PVP
40	A221.040	-
60	A221.060	-
70	A221.070	-
80	A221.080	-
90	A221.090	-
100	A221.100	-
120	A221.120	-
140	A221.140	-

### MODULI SOSPESI

#### 1 CASSETTO + DECORATIVO

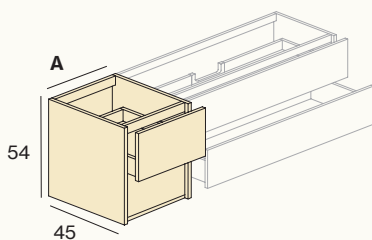

A (cm)	COD	LEGNO NATURE		LACCA	
		BLACK-INCOLOR-NEO-RAIL	PUSH	BLACK-CURVE-LINEAL-INCOLOR-INGLETE-NEO-RAIL	LINE-GLASS-FRAME-PUSH
30	P203.030.M	-	-	-	-
40	P203.040.M	-	-	-	-
60	P203.060.M	-	-	-	-
70	P203.070.M	-	-	-	-
80	P203.080.M	-	-	-	-
90	P203.090.M	-	-	-	-
100	P203.100.M	-	-	-	-
120	P203.120.M	-	-	-	-
140	P203.140.M	-	-	-	-

#### RIPIANI DECORATIVI

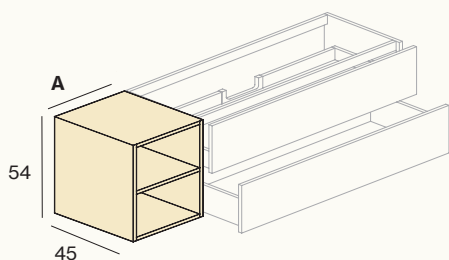

30	P207.030.M	-	-	-	-
40	P207.040.M	-	-	-	-
60	P207.060.M	-	-	-	-
70	P207.070.M	-	-	-	-
80	P207.080.M	-	-	-	-

#### 1 CASSETTO + ANTA

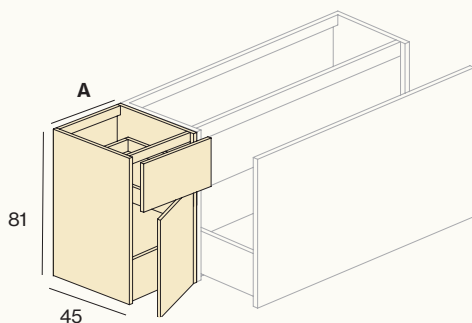

A (cm)	ANTA	COD	LEGNO NATURE		LACCA	
			BLACK-INCOLOR-NEO-RAIL	PUSH	BLACK-CURVE-LINEAL-INCOLOR-INGLETE-NEO-RAIL	LINE-GLASS-FRAME-PUSH
30		P314.030.MI	-	-	-	-
30		P314.030.MD	-	-	-	-
40		P314.040.MI	-	-	-	-
40		P314.040.MD	-	-	-	-



· Puoi creare il tuo arredo personalizzato aggiungendo i moduli a destra e / o sinistra della base lavabo selezionata. Specifica la loro posizione.

MODULI SOSPESI

3 CASSETTI

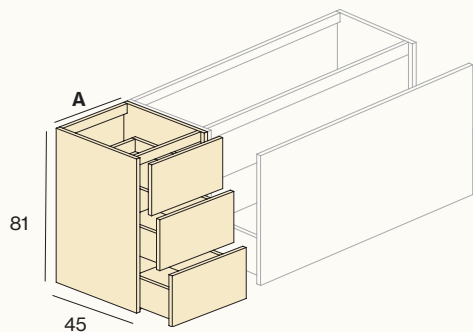

A (cm)	COD	LEGNO NATURE		LACCA	
		BLACK-INCOLOR-NEO-RAIL	PUSH	BLACK-CURVE-LINEAL-INCOLOR-INGLETE-NEO-RAIL	LINE-GLASS-FRAME-PUSH
30	P313.030.M	-	-	-	-
40	P313.040.M	-	-	-	-
60	P313.060.M	-	-	-	-
70	P313.070.M	-	-	-	-
80	P313.080.M	-	-	-	-
90	P313.090.M	-	-	-	-
100	P313.100.M	-	-	-	-
120	P313.120.M	-	-	-	-

MODULI STRUTTURA METALLIC A SOSPESA

METALLIZZATO DECORATIVO

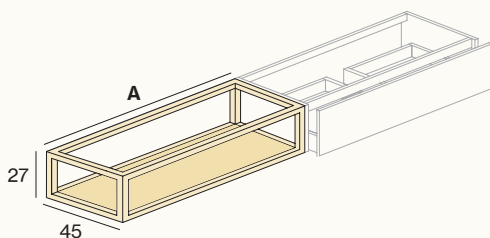

A (cm)	COD	NEGRO			COLORE		
		LEGNO NATURE	LACCA	CRISTALLO FUMÉ	LEGNO NATURE	LACCA	CRISTALLO FUMÉ
30	P105.030.M	-	-	-	-	-	-
40	P105.040.M	-	-	-	-	-	-
60	P105.060.M	-	-	-	-	-	-
70	P105.070.M	-	-	-	-	-	-
80	P105.080.M	-	-	-	-	-	-
90	P105.090.M	-	-	-	-	-	-
100	P105.100.M	-	-	-	-	-	-
120	P105.120.M	-	-	-	-	-	-
140	P105.140.M	-	-	-	-	-	-

DECORATIVO METALLIZZATO H54

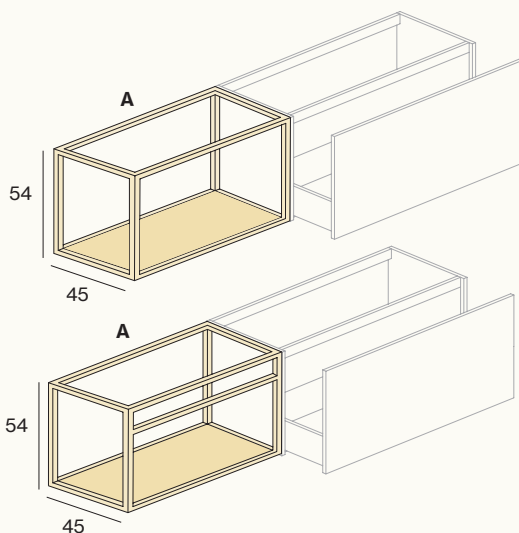

30	P214.030.M	-	-	-	-	-	-
40	P214.040.M	-	-	-	-	-	-
60	P214.060.M	-	-	-	-	-	-
70	P214.070.M	-	-	-	-	-	-
80	P214.080.M	-	-	-	-	-	-
90	P214.090.M	-	-	-	-	-	-
100	P214.100.M	-	-	-	-	-	-
120	P214.120.M	-	-	-	-	-	-
140	P214.140.M	-	-	-	-	-	-

  

30	P216.030.M	-	-	-	-	-	-
40	P216.040.M	-	-	-	-	-	-
60	P216.060.M	-	-	-	-	-	-
70	P216.070.M	-	-	-	-	-	-
80	P216.080.M	-	-	-	-	-	-
90	P216.090.M	-	-	-	-	-	-
100	P216.100.M	-	-	-	-	-	-
120	P216.120.M	-	-	-	-	-	-
140	P216.140.M	-	-	-	-	-	-

### MOBILI PER INTERNI

#### DECOSPACE

Sistema che include un sifone salvaspazio e una valvola click-clack cromata lucida. Questa soluzione consente al cassetto superiore di andare senza registro a sifone.

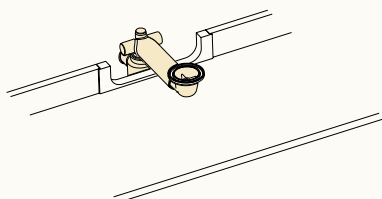

#### COD

#### PVP

CM13  
CM13X2

-  
-

#### ORGADRAW

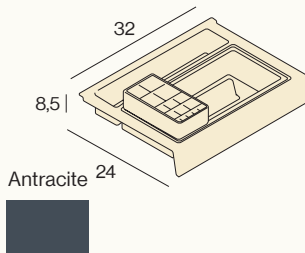

#### COD

#### PVP

CM1

-

#### ORGASTRIP

Sistema separatore guidato su rotaia.

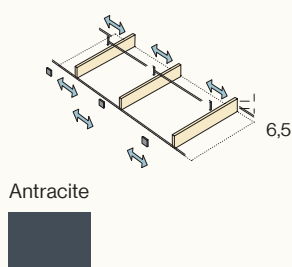

#### A

#### COD

#### SEPARATORI

#### PVP

30	CM2.030	1	-
40	CM2.040	1	-
60	CM2.060	2	-
70	CM2.070	2	-
80	CM2.080	3	-
90	CM2.090	3	-
100	CM2.100	4	-
120	CM2.120	4	-
140	CM2.140	4	-

#### Separatore aggiuntivo

CM2.010

1

-

#### PROTEZIONE DEL CASSETTO

Telo protettivo antiscivolo per cassetto.

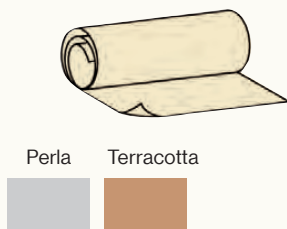

#### A

#### PERLA

#### TERRACOTTA

#### COD

#### PVP

#### COD

#### PVP

30	CM3.030	-	CM4.030	-
40	CM3.040	-	CM4.040	-
60	CM3.060	-	CM4.060	-
70	CM3.070	-	CM4.070	-
80	CM3.080	-	CM4.080	-
90	CM3.090	-	CM4.090	-
100	CM3.100	-	CM4.100	-
120	CM3.120	-	CM4.120	-
140	CM3.140	-	CM4.140	-



### GAMBE PER MOBILI

#### STRUTTURA METALLICA PER MOBILI H27

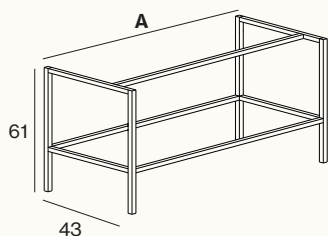

A (cm)	COD	NEGRO			COLORE		
		LEGNO NATURE	LACCA	CRISTALLO FUMÉ	LEGNO NATURE	LACCA	CRISTALLO FUMÉ
60	CM14.060	-	-	-	-	-	-
70	CM14.070	-	-	-	-	-	-
80	CM14.080	-	-	-	-	-	-
90	CM14.090	-	-	-	-	-	-
100	CM14.100	-	-	-	-	-	-
120	CM14.120	-	-	-	-	-	-
140	CM14.140	-	-	-	-	-	-

#### Colori



#### STRUTTURA METALLICA PER MOBILI H54

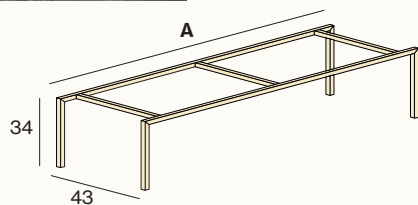

A	COD	NEGRO	COLORE
60	CM5.060	-	-
70	CM5.070	-	-
80	CM5.080	-	-
90	CM5.090	-	-
100	CM5.100	-	-
120	CM5.120	-	-
140	CM5.140	-	-
160	CM5.160	-	-
180	CM5.180	-	-
200	CM5.200	-	-

La misura del fondo della struttura e' approssimativamente di 2 cm inferiore rispetto al fondo del mobile per non interferire con i frontali.

#### Colori



#### GAMBE H3

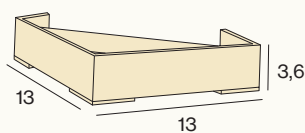

Cromo lucido



#### COD

CM6

#### PVP

-

Set di 4 unità

#### GAMBE H7

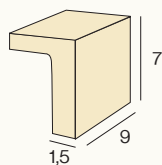

Cromo lucido



#### COD

CM7

#### PVP

-

Set di 4 unità

### MOBILI DA ESTERNO

#### PORTA ASCIUGAMANO LATERALE

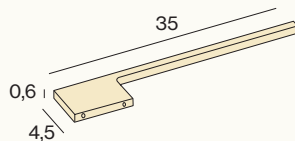

COLORE	COD	PVP
--------	-----	-----

Cromo lucido	CM8.CB	-
Nero opaco	CM8.BK	-
Colore (lettera laccata)	CM8.CO	-

#### Colori



#### PORTA ASCIUGAMANO CON GAMBE

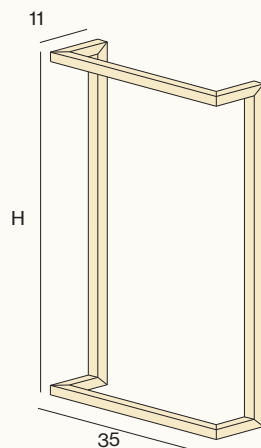

H	COLORE	COD	PVP
---	--------	-----	-----

75	Nero opaco	CM9.75.BK	-
75	Colore (lettera laccata)	CM9.75.CO	-
85	Nero opaco	CM9.85.BK	-
85	Colore (lettera laccata)	CM9.85.CO	-

Mobile H = 85 cm con lavabo integrato.

Mobile H = 75 cm con lavabo con piana.

#### Colori



#### RETROILLUMINAZIONE INFERIORE

Illuminazione sotto i mobili, sotto il controsoffitto, pensile.

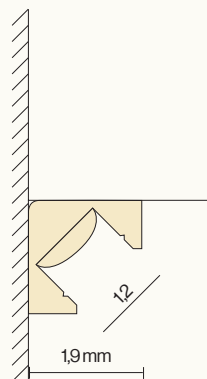

A	COD	PVP
---	-----	-----

60	CM10.060	-
70	CM10.070	-
80	CM10.080	-
90	CM10.090	-
100	CM10.100	-
120	CM10.120	-
140	CM10.140	-
160	CM10.160	-
180	CM10.180	-
200	CM10.200	-

La misura reale dell'illuminazione a LED è di 4 centimetri più bassa della larghezza del mobile in modo che non sia visibile di lato.

LUZ	COLORE °K	CONSUMO	POTENZA	TENUTA STAGNA	DRIVER	MATERIALE
LED	4000°K Neutro	4,8W	400 LUMENS metro lineare	IP67	INCLUSO	ALUMINIO

Personalizza il tuo LED in 3000°K e 4200°K senza extra costo. Standard in 4000°K.

### MOBILI DA ESTERNO

#### REGOLAZIONE DELLA PARETE



H	COD	LEGNO NATURE	LACCA
27	CM11.27	-	-
54	CM11.54	-	-
81	CM11.81	-	-

Da definire secondo necessità.

#### DECORATIVI LATERALI

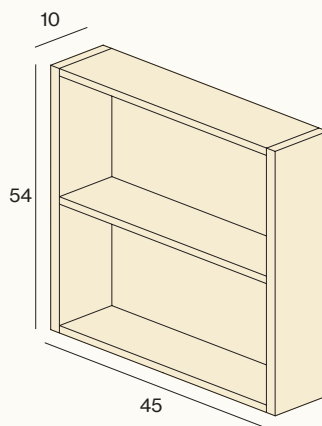

COD	LEGNO NATURE	LACCA
CM12	-	-



# Step

Caratteristiche e attrezzature	254
Personalizza i tuoi mobili Step	255
Basi lavabo sospese	256
Basi lavabo sospese + top	257

**CASSETTI 3D**

Cassetti in metallo Hettich colore antracite con 4 regolazioni. Le guide sono ad estrazione totale e impianto frenante progressivo.

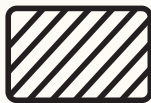
**FULLCOLOR ANTRACITE**

Idea di design d'interni per cui tutti i materiali degli interni dei mobili sono progettati in colore antracite. Il mobile con finitura laccata è internamente laccato antracite.

**DECOBUILD SYSTEM**

Mobili realizzati con tavole da 19 mm incollate insieme ottenendo un'estetica pulita senza inserti visibili, offre una migliore resistenza e durezza.

**SISTEMA DI SICUREZZA PENSILE SCARICA 150 KG**

Le colonne e gli armadi hanno un sistema di sospensione di sicurezza con una capacità di carico di 150 Kg.

## Scegli la tua composizione Step personalizzata

Prodotti sempre disponibili

- ✔ Una finiture
- ✔ Due colori
- ✔ Tre lavabi

### A Scegli il colore

Laccato

Legno Nature

Blanco Opaco

Sand

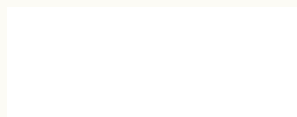

### B Scegli il piano lavabo

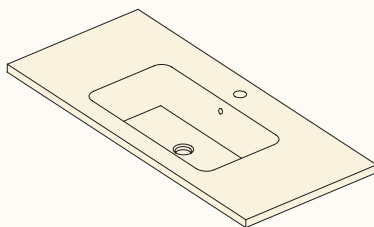

CERAMICA

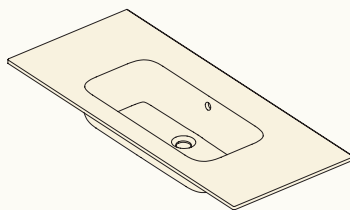

SOLID MINERAL - LUCIDO

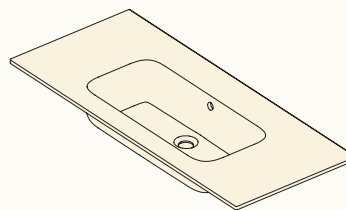

SOLID MINERAL - OPACO

### BASI PER LAVABO SOSPESO

2 CASSETTI

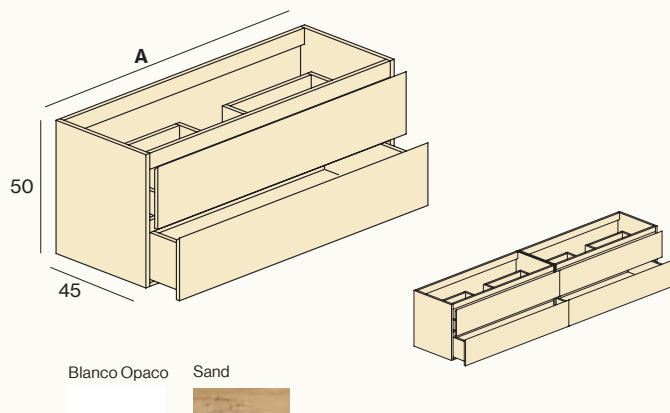

A (cm)	LAVABO	BLANCO	SAND	PVP
		COD	COD	
<b>60</b>		S201.060.CB	S201.060.CS	-
<b>80</b>		S201.080.CB	S201.080.CS	-
<b>100</b>		S201.100.CB	S201.100.CS	-
<b>120</b>		S201.120.CB	S201.120.CS	-
<b>120X</b>		S201.120.XB	S201.120.XS	-



· Prodotto in magazzino.



### PACK MOBILI + PIANO DI LAVORO

#### 2 CASSETTI + PIANO IN CERAMICA

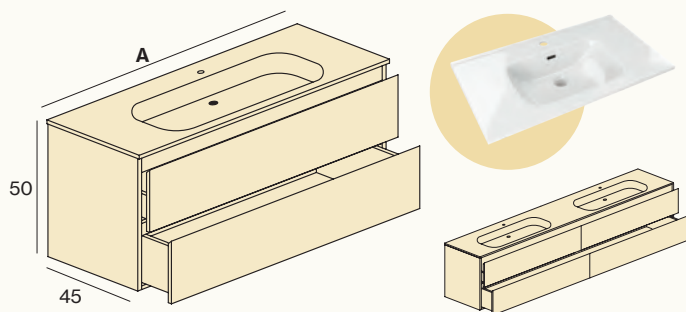

Blanco Opaco Sand



A (cm)	LAVABO	BLANCO	SAND	PVP
		COD	COD	
60		S901.060.CB	S901.060.CS	-
80		S901.080.CB	S901.080.CS	-
100		S901.100.CB	S901.100.CS	-
120		S901.120.CB	S901.120.CS	-
120X		S901.120.XB	S901.120.XS	-

#### 2 CASSETTI + PIANO DI LAVORO - HARD (Lucido)

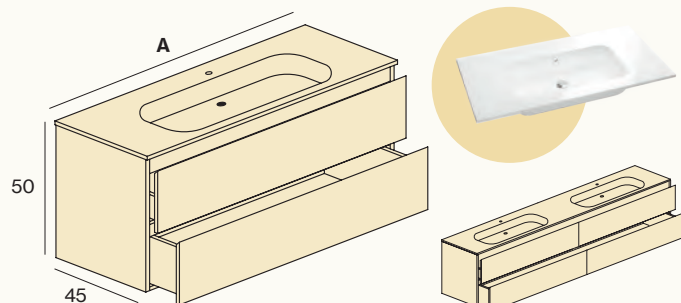

Blanco Opaco Sand



A (cm)	LAVABO	BLANCO	SAND	PVP
		COD	COD	
60		S902.060.CB	S902.060.CS	-
80		S902.080.CB	S902.080.CS	-
100		S902.100.CB	S902.100.CS	-
120		S902.120.CB	S902.120.CS	-
120X		S902.120.XB	S902.120.XS	-

#### 2 CASSETTI + PIANO SOLIDMINERAL - HARD (Opaco)

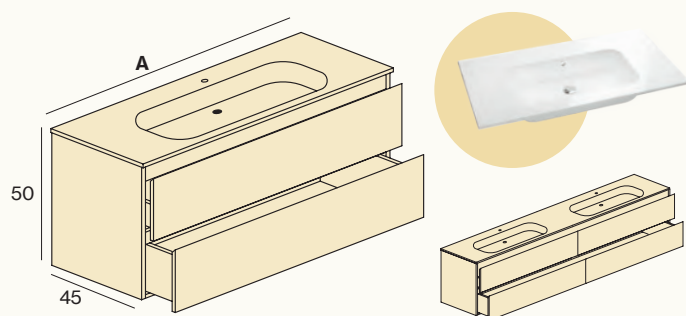

Blanco Opaco Sand



A (cm)	LAVABO	BLANCO	SAND	PVP
		COD	COD	
60		S903.060.CB	S903.060.CS	-
80		S903.080.CB	S903.080.CS	-
100		S903.100.CB	S903.100.CS	-
120		S903.120.CB	S903.120.CS	-
120X		S903.120.XB	S903.120.XS	-



· Prodotto in magazzino.



# 03

## Piani lavabo

Integrati, piatti, lavelli, soluzioni  
e materiali per ogni esigenza.

## MATERIALI

Per conoscere le caratteristiche dei nostri materiali per piani lavabo e lavabi, consultare pagina 351.

## PIANO LAVABO CON VASCA INTEGRATA STANDARD

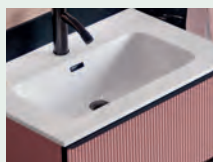
**Ceramica**

pag. 262

**Glass Bianco**

pag. 263

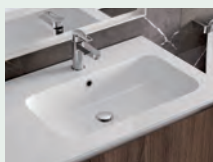
**Solid Mineral**

pag. 264

## PIANI LAVABO CON LAVABO INTEGRATO SU MISURA

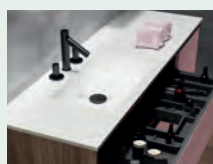
**Solid Mineral**

pag. 268

**Solid Surface**  **eco**

pag. 270

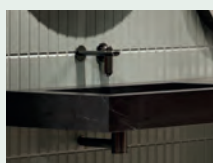
**Pietra Naturale**

pag. 272

**Cristalcolor**

pag. 274

## LAVABO DA APPOGGIO

**Ceramica /  
Ceramcolor**

pag. 276

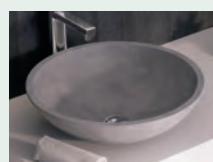
**Microcemento**

pag. 279

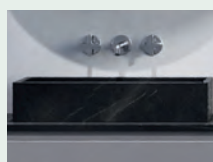
**Pietra Naturale**

pag. 279

**Solid Surface**  **eco**

pag. 280

**TOTEM**



**Solid Surface**  *eco*

pag. 283

**PIANI LAVABO**



**Legno Nature**

pag. 284



**Lacca**

pag. 285



**Compensato  
Multistrato Marino**

pag. 286

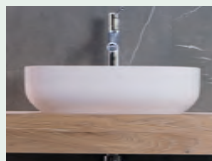

**Legno  
Rovere Massello**

pag. 287

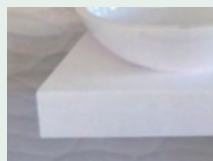

**Solid Mineral**

pag. 288

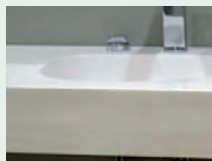

**Solid Surface**  *eco*

pag. 289



**Ceramcolor**

pag. 290



**Pietra Naturale**

pag. 291

**ACCESSORI DA APPOGGIO**



**Supporti a parete**

pag. 292



**Pilette**

pag. 292



**Sifoni decorativi**

pag. 293



**Portasciugamani**

pag. 293

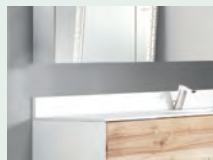

**Alzatina per mobile**

pag. 293

CERAMICA

CERAMICS

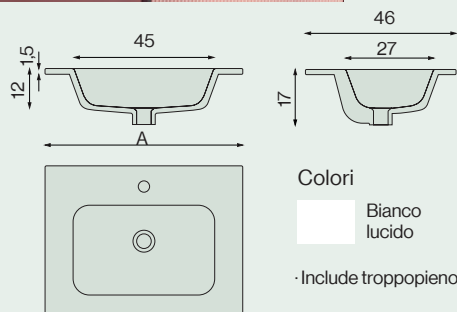

POSIZIONE LAVABO

A (cm)

E (cm)

COD

PVP

CENTRATO

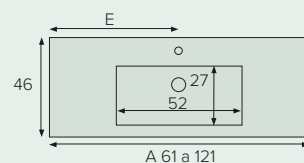

61	30	EC.061.C	-
71	35	EC.071.C	-
81	40	EC.081.C	-
91	45	EC.091.C	-
101	50	EC.101.C	-
121	60	EC.121.C	-

DESTRA

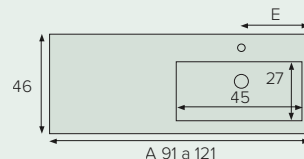

91	30	EC.091.D	-
101	35	EC.101.D	-
121	30	EC.121.D	-

SINISTRA

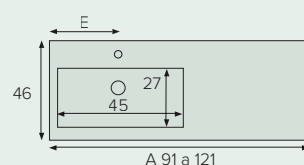

91	30	EC.091.I	-
101	35	EC.101.I	-
121	40	EC.121.I	-

DOPPIO

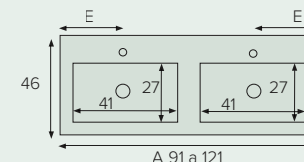

121	30	EC.121.X	-
141	35	EC.141.X	-

CERAMICS Profondità 39

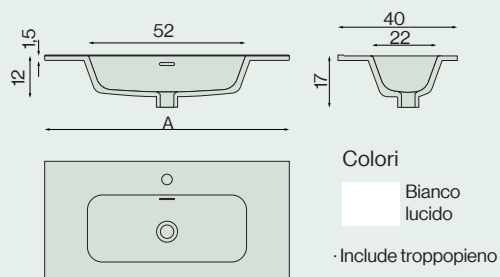

POSIZIONE LAVABO

A (cm)

E (cm)

COD

PVP

CENTRATO

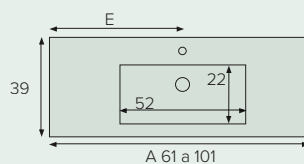

61	30	EC.061.R	-
71	35	EC.071.R	-
81	45	EC.081.R	-
101	50	EC.101.R	-

### GLASS BLANCO

### GLASS BLANCO

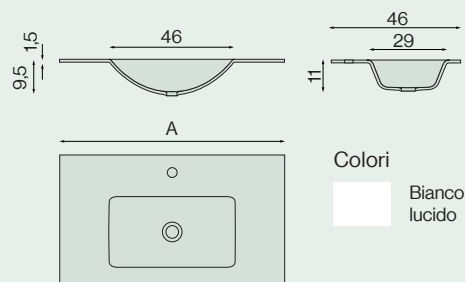

Colori  
 Bianco lucido

### POSIZIONE LAVABO

A (cm) E (cm)

COD

PVP

#### CENTRATO

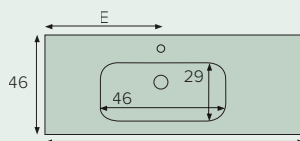

<b>61</b>	30	EL.061.C	-
<b>71</b>	35	EL.071.C	-
<b>81</b>	40	EL.081.C	-
<b>91</b>	45	EL.091.C	-
<b>101</b>	50	EL.101.C	-
<b>121</b>	60	EL.121.C	-

#### SINISTRA

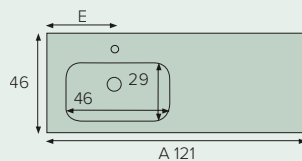

<b>121</b>	40	EL.121.I	-
------------	----	----------	---

#### DOPPIO

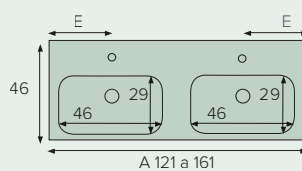

<b>121</b>	30	EL.121.X	-
<b>141</b>	35	EL.141.X	-
<b>161</b>	40	EL.161.X	-

### & complementi

Pilette e sifoni  
 pagina 292

### SOLID MINERAL

#### HARD

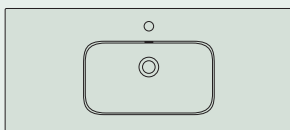
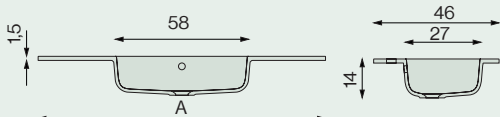

#### Colori

- Bianco lucido
- Bianco opaco

· Include troppopieno

#### POSIZIONE LAVABO

A (cm) E (cm) Opaco Lucido PVP

#### CENTRATO

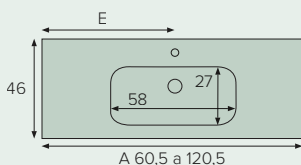

60,5	30	EH.061.CM	EH.061.CB	-
70,5	35	EH.071.CM	EH.071.CB	-
80,5	40	EH.081.CM	EH.081.CB	-
90,5	45	EH.091.CM	EH.091.CB	-
100,5	50	EH.101.CM	EH.101.CB	-
120,5	60	EH.121.CM	EH.121.CB	-

#### SINISTRA

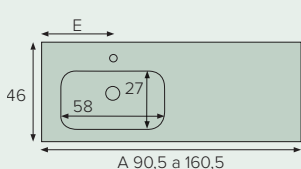

90,5	30	EH.091.IM	EH.091.IB	-
100,5	30	EH.101.IM	EH.101.IB	-
120,5	40	EH.121.IM	EH.121.IB	-
140,5	35	EH.141.IM	EH.141.IB	-
160,5	40	EH.161.IM	EH.161.IB	-

#### DESTRA

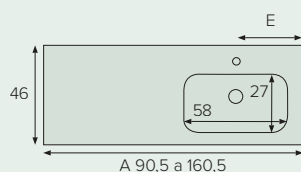

90,5	30	EH.091.DM	EH.091.DB	-
100,5	30	EH.101.DM	EH.101.DB	-
120,5	40	EH.121.DM	EH.121.DB	-
140,5	35	EH.141.DM	EH.141.DB	-
160,5	40	EH.161.DM	EH.161.DB	-

#### DOPPIO

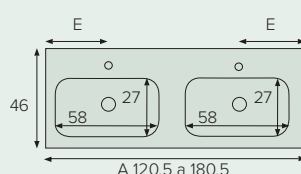

120,5	30	EH.121.XM	EH.121.XB	-
140,5	35	EH.141.XM	EH.141.XB	-
160,5	40	EH.161.XM	EH.161.XB	-
180,5	45	EH.181.XM	EH.181.XB	-

· Per piani lavabo da 60,5 e 120,5 e 140,5 doppio, il lavabo è profondo 48 cm

#### MUR

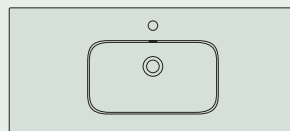
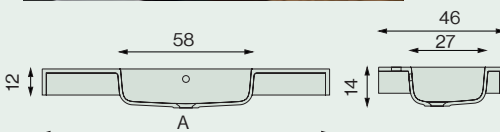

#### Colori

- Bianco lucido
- Bianco opaco

· Staffe incluse  
· Include troppopieno

#### POSIZIONE LAVABO

A (cm) E (cm) Opaco Lucido PVP

#### CENTRATO

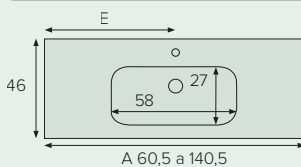

60,5	30	EM.061.CM	EM.061.CB	-
70,5	35	EM.071.CM	EM.071.CB	-
80,5	40	EM.081.CM	EM.081.CB	-
90,5	45	EM.091.CM	EM.091.CB	-
100,5	50	EM.101.CM	EM.101.CB	-
120,5	60	EM.121.CM	EM.121.CB	-
140,5	60	EM.141.CM	EM.141.CB	-

#### SINISTRA

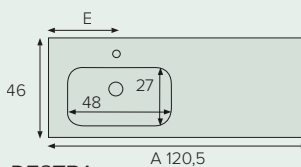

120,5	30	EM.121.IM	EM.121.IB	-
-------	----	-----------	-----------	---

#### DESTRA

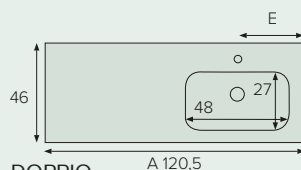

120,5	30	EM.121.DM	EM.121.DB	-
-------	----	-----------	-----------	---

#### DOPPIO

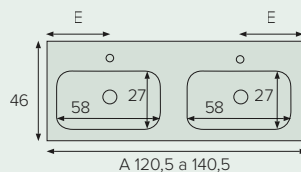

120,5	30	EM.121.XM	EM.121.XB	-
140,5	35	EM.141.XM	EM.141.XB	-

· Per piani lavabo da 60,5 cm e 120,5 cm doppio, il lavabo è profondo 48,5 cm



### SOLID MINERAL

#### PRISMA

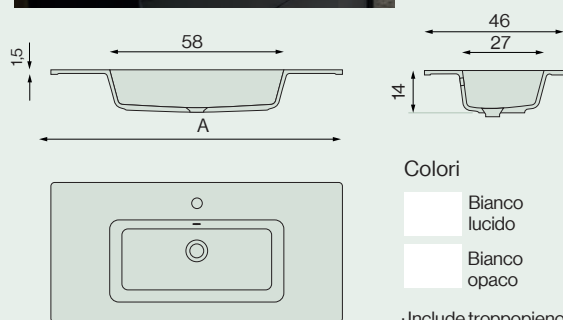
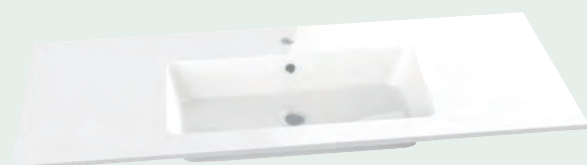

Colori  
 Bianco lucido  
 Bianco opaco

· Include troppopieno

#### POSIZIONE LAVABO A (cm) E (cm) Opaco Lucido PVP

##### CENTRATO

A (cm)	E (cm)	Opaco	Lucido	PVP
60,5	30	EP061.CM	EP061.CB	-
80,5	40	EP081.CM	EP081.CB	-
90,5	45	EP091.CM	EP091.CB	-
100,5	50	EP101.CM	EP101.CB	-
120,5	60	EP121.CM	EP121.CB	-

##### SINISTRA

A (cm)	E (cm)	Opaco	Lucido	PVP
120,5	30	EP121.IM	EP121.IB	-

##### DESTRA

A (cm)	E (cm)	Opaco	Lucido	PVP
120,5	30	EP121.DM	EP121.DB	-

##### DOPPIO

A (cm)	E (cm)	Opaco	Lucido	PVP
120,5	30	EP121.XM	EP121.XB	-
140,5	35	EP141.XM	EP141.XB	-

· Per piani lavabo da 60,5 cm e 120,5 cm doppio, il lavabo è profondo 48,5 cm

#### WALL

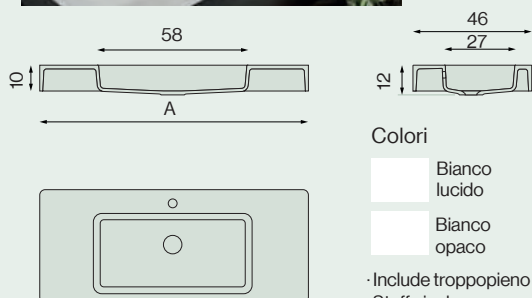

Colori  
 Bianco lucido  
 Bianco opaco

· Include troppopieno  
 · Staffe incluse

#### POSIZIONE LAVABO A (cm) E (cm) Opaco Lucido PVP

##### CENTRATO

A (cm)	E (cm)	Opaco	Lucido	PVP
60,5	30	EA.061.CM	EA.061.CB	-
80,5	40	EA.081.CM	EA.081.CB	-
90,5	45	EA.091.CM	EA.091.CB	-
100,5	50	EA.101.CM	EA.101.CB	-
120,5	60	EA.121.CM	EA.121.CB	-

##### DOPPIO

A (cm)	E (cm)	Opaco	Lucido	PVP
120,5	30	EA121.XM	EA121.XB	-
140,5	35	EA141.XM	EA141.XB	-

· Per piani lavabo da 60,5 cm e 120,5 cm doppio, il lavabo è profondo 48,5 cm

#### & complementi

Pilette e sifoni  
 pagina 292

### SOLID MINERAL

#### WAVE

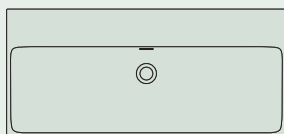
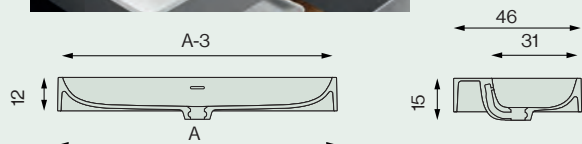

#### Colori

- Bianco lucido
- Bianco opaco

#### POSIZIONE LAVABO

A (cm) E (cm)

Opaco

Lucido

PVP

#### CENTRATO

A (cm)	E (cm)	Opaco	Lucido	PVP
60,5	30	EW.061.CM	EW.061.CB	-
70,5	35	EW.071.CM	EW.071.CB	-
80,5	40	EW.081.CM	EW.081.CB	-
90,5	45	EW.091.CM	EW.091.CB	-
100,5	50	EW.101.CM	EW.101.CB	-

#### DOPPIO

A (cm)	E (cm)	Opaco	Lucido	PVP
120,5	30	EW.121.XM	EW.121.XB	-

- Profilo spesso 1,5 cm
- Include troppopieno
- Include staffe di fissaggio a parete

#### THIN

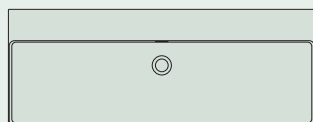
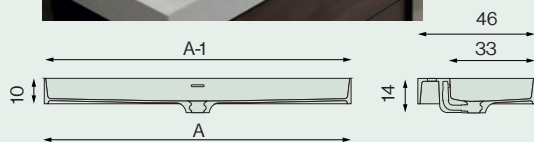
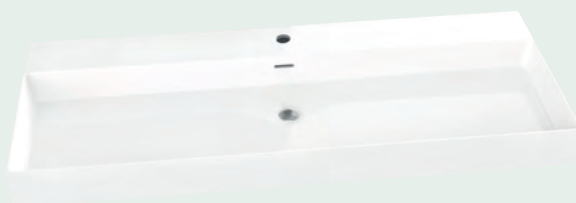

#### Colori

- Bianco opaco

#### POSIZIONE LAVABO

A (cm) E (cm)

Opaco

PVP

#### CENTRATO

A (cm)	E (cm)	Opaco	PVP
60,5	30	ET.061.CM	-
70,5	35	ET.071.CM	-
80,5	40	ET.081.CM	-
90,5	45	ET.091.CM	-
100,5	50	ET.101.CM	-
120,5	60	ET.121.CM	-

- Spessore profilo 0,5 cm
- Include troppopieno
- Include staffe di fissaggio a parete

### SOLID MINERAL

#### FLY

#### POSIZIONE LAVABO

A (cm) E (cm)

Opaco

Lucido

PVP

#### CENTRATO

A (cm)	E (cm)	Opaco	Lucido	PVP
60,5	30	EF.061.CM	EF.061.CB	-
70,5	35	EF.071.CM	EF.071.CB	-
80,5	40	EF.081.CM	EF.081.CB	-
90,5	45	EF.091.CM	EF.091.CB	-
100,5	50	EF.101.CM	EF.101.CB	-
120,5	60	EF.121.CM	EF.121.CB	-

#### SINISTRA

A (cm)	E (cm)	Opaco	Lucido	PVP
120,5	30	EF.121.IM	EF.121.IB	-

#### DESTRA

A (cm)	E (cm)	Opaco	Lucido	PVP
120,5	30	EF.121.DM	EF.121.DB	-

#### DOPPIO

A (cm)	E (cm)	Opaco	Lucido	PVP
120,5	30	EF.121.XM	EF.121.XB	-
140,5	35	EF.141.XM	EF.141.XB	-

· Per piani lavabo de 60,5 cm e piani lavabo doppio de 120,5 il lavabo è 50,5 · 35 cm

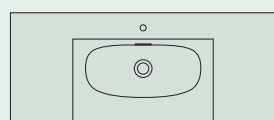
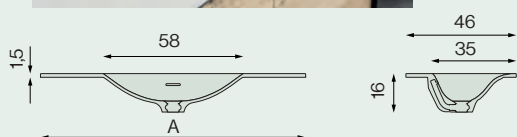
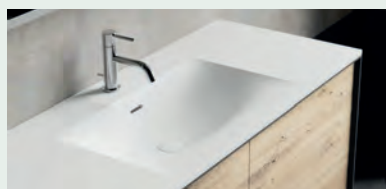

Colori  
 Bianco lucido  
 Bianco opaco

#### HUG



· Il piano lavabo può essere ordinato senza foro rubinetto  
 · Sono disponibili altri modelli speciali

#### POSIZIONE

A (cm)

E (cm)

Opaco

PVP

#### DESTRA

A (cm)	E (cm)	Opaco	PVP
90	50	EG.090.DM	-
110	60	EG.110.DM	-
130	70	EG.130.DM	-

#### SINISTRA

A (cm)	E (cm)	Opaco	PVP
90	50	EG.090.IM	-
110	60	EG.110.IM	-
130	70	EG.130.IM	-

Colori  
 Bianco opaco

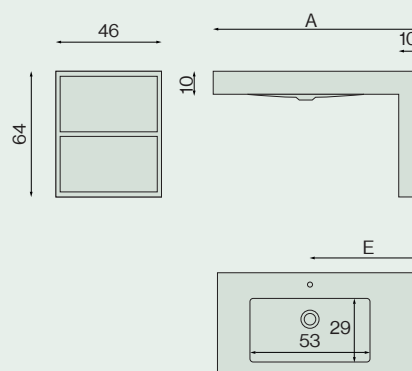

#### & complementi

Pilette e sifoni  
 pagina 292

### SOLID MINERAL

Materiale composto da cariche minerali e resine metacrilate ad alta resistenza. Non poroso e molto setoso al tatto.

PERSONALIZZA E CONFIGURA SU MISURA - Scegli la dimensione e lo spessore e aggiungi il lavabo desiderato



Colori

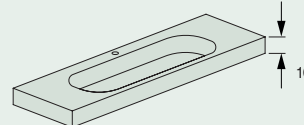
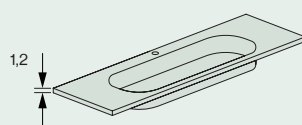
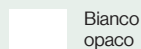

POSIZIONE LAVABO	A (cm)	E (cm)	COD	PVP	COD	PVP
<b>CENTRATO</b>						
	61	30	ES.061.CP	-	ES.061.CM	-
	71	35	ES.071.CP	-	ES.071.CM	-
	81	40	ES.081.CP	-	ES.081.CM	-
	91	45	ES.091.CP	-	ES.091.CM	-
	101	50	ES.101.CP	-	ES.101.CM	-
	121	60	ES.121.CP	-	ES.121.CM	-
	141	70	ES.141.CP	-	ES.141.CM	-
	161	80	ES.161.CP	-	ES.161.CM	-
181	90	ES.181.CP	-	ES.181.CM	-	
201	100	ES.201.CP	-	ES.201.CM	-	
<b>SINISTRA</b>						
	91	30	ES.091.IP	-	ES.091.IM	-
	101	35	ES.101.IP	-	ES.101.IM	-
	121	40	ES.121.IP	-	ES.121.IM	-
	141	35	ES.141.IP	-	ES.141.IM	-
	161	40	ES.161.IP	-	ES.161.IM	-
181	45	ES.181.IP	-	ES.181.IM	-	
201	50	ES.201.IP	-	ES.201.IM	-	
<b>DESTRA</b>						
	91	30	ES.091.DP	-	ES.091.DM	-
	101	35	ES.101.DP	-	ES.101.DM	-
	121	40	ES.121.DP	-	ES.121.DM	-
	141	35	ES.141.DP	-	ES.141.DM	-
	161	40	ES.161.DP	-	ES.161.DM	-
181	45	ES.181.DP	-	ES.181.DM	-	
201	50	ES.201.DP	-	ES.201.DM	-	
<b>DOPPIO</b>						
	121	30	ES.121.XP	-	ES.121.XM	-
	141	35	ES.141.XP	-	ES.141.XM	-
	161	40	ES.161.XP	-	ES.161.XM	-
	181	45	ES.181.XP	-	ES.181.XM	-
	201	50	ES.201.XP	-	ES.201.XM	-



#### MISURE SPECIALI

È possibile ordinare senza sovrapprezzo:

- Larghezze speciali. Prezzo della misura più alta.

- Altezza copertura da 5 a 10 cm.

#### FORO PER RUBINETTO E LAVABO

- È possibile ordinare il piano cottura senza foro rubinetto.

- Sifone del lavabo secondo necessità.

- Disponibile con troppopieno.

#### & complementi

Pilette e sifoni,  
Supporti da banco,  
Portasciugamani,  
Battiscopa  
paginas 292-293

LAVABI DISPONIBILI

MINI



OBI



LIENA

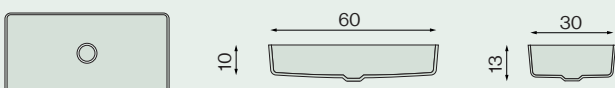

- Piani lavabo disponibili da 70 cm.
- Disponibile con doppio piano lavabo da 140 cm.

AMUR

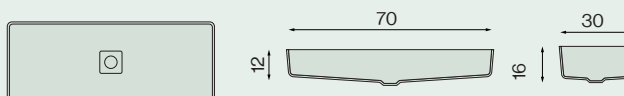

- Piani lavabo disponibili da 80 cm.
- Disponibile con doppio piano lavabo da 160 cm.

VOIGA

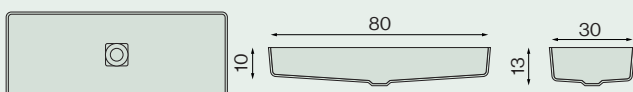

- Piani lavabo disponibili da 90 cm.
- Disponibile con doppio piano lavabo da 180 cm.

SKYE

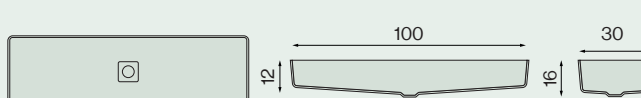

- Piani lavabo disponibili da 100 cm.
- Non disponibile per piani lavabo doppi.

OVAL

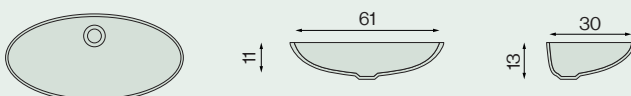

- Piani lavabo disponibili da 70 cm.
- Disponibile con doppio piano lavabo da 140 cm.

EXTRA KIT REDGE



COD	PVP
CE29	-

SOLID SURFACE 

**Cristalplant è un Solid Surface composto da cariche minerali e resine Biobased. Materiale non poroso, antibatterico e setoso al tatto. PERSONALIZZA E CONFIGURA SU MISURA - Scegli la dimensione e lo spessore e aggiungi il lavabo desiderato**

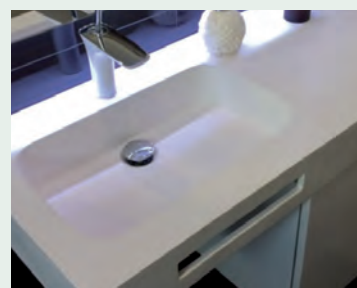

Colori

 Bianco opaco

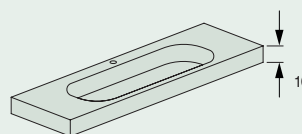
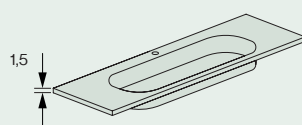

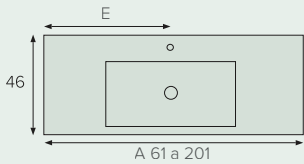
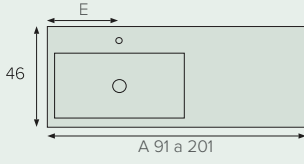
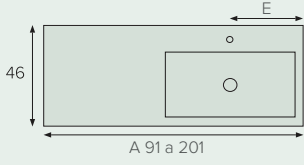
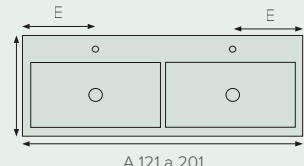
POSIZIONE LAVABO	A (cm)	E (cm)	COD	PVP	COD	PVP
<b>CENTRATO</b>						
	61	30	EJ.061.CP	-	EJ.061.CM	-
	71	35	EJ.071.CP	-	EJ.071.CM	-
	81	40	EJ.081.CP	-	EJ.081.CM	-
	91	45	EJ.091.CP	-	EJ.091.CM	-
	101	50	EJ.101.CP	-	EJ.101.CM	-
	121	60	EJ.121.CP	-	EJ.121.CM	-
	141	70	EJ.141.CP	-	EJ.141.CM	-
	161	80	EJ.161.CP	-	EJ.161.CM	-
181	90	EJ.181.CP	-	EJ.181.CM	-	
201	100	EJ.201.CP	-	EJ.201.CM	-	
<b>SINISTRA</b>						
	91	30	EJ.091.IP	-	EJ.091.IM	-
	101	35	EJ.101.IP	-	EJ.101.IM	-
	121	40	EJ.121.IP	-	EJ.121.IM	-
	141	35	EJ.141.IP	-	EJ.141.IM	-
	161	40	EJ.161.IP	-	EJ.161.IM	-
181	45	EJ.181.IP	-	EJ.181.IM	-	
201	50	EJ.201.IP	-	EJ.201.IM	-	
<b>DESTRA</b>						
	91	30	EJ.091.DP	-	EJ.091.DM	-
	101	35	EJ.101.DP	-	EJ.101.DM	-
	121	40	EJ.121.DP	-	EJ.121.DM	-
	141	35	EJ.141.DP	-	EJ.141.DM	-
	161	40	EJ.161.DP	-	EJ.161.DM	-
181	45	EJ.181.DP	-	EJ.181.DM	-	
201	50	EJ.201.DP	-	EJ.201.DM	-	
<b>DOPIO</b>						
	121	30	EJ.121.XP	-	EJ.121.XM	-
	141	35	EJ.141.XP	-	EJ.141.XM	-
	161	40	EJ.161.XP	-	EJ.161.XM	-
	181	45	EJ.181.XP	-	EJ.181.XM	-
	201	50	EJ.201.XP	-	EJ.201.XM	-



**MISURE SPECIALI**

È possibile ordinare senza sovrapprezzo:

- Larghezze speciali. Prezzo della misura più alta.
- Altezza copertura da 5 a 10 cm.

**FORO PER RUBINETTO E LAVABO**

- È possibile ordinare il piano cottura senza foro rubinetto.
- Sifone del lavabo secondo necessità.
- Disponibile con troppopieno.

**& complementi**

Pilette e sifoni,  
Supporti da banco,  
Portasciugamani,  
Battiscopa  
paginas 292-293

LAVABI DISPONIBILI

VICTORIA

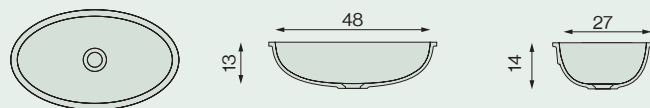

ONTARIO

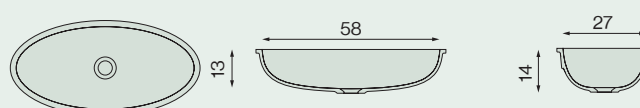

- Disponibile a partire da 70 cm.
- Disponibile doppio a partire da 140 cm.

BAIKAL

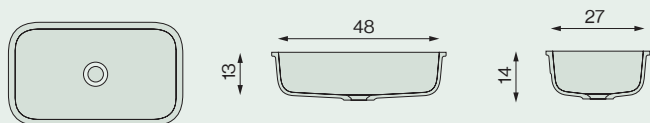

NYASSA

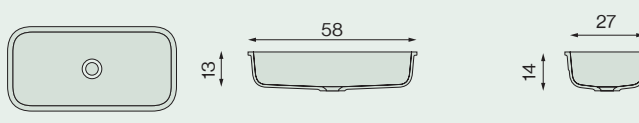

- Disponibile a partire da 70 cm.
- Disponibile doppio a partire da 140 cm.

NESS

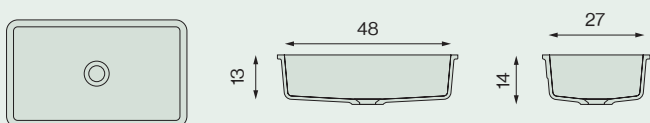

ERIE

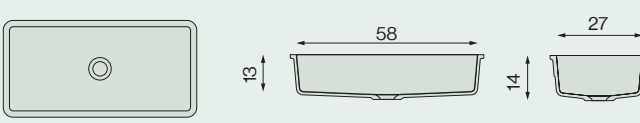

- Disponibile a partire da 70 cm.
- Disponibile doppio a partire da 140 cm.

NASSER

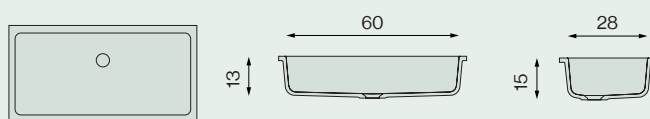

- Disponibile a partire da 70 cm.
- Disponibile doppio a partire da 140 cm.

EXTRA KIT REDGE



COD PVP

CE30 -

### PIETRA NATURALE

#### PERSONALIZZA E CONFIGURA LA MISURA

Scegli la misura e aggiungi il lavabo desiderato.



Colori

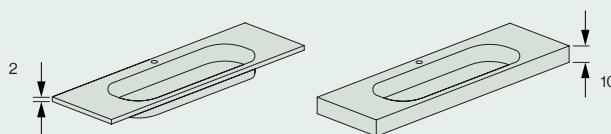
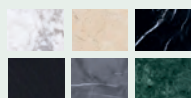

POSIZIONE LAVABO	A (cm)	E (cm)	COD	PVP	COD	PVP
<b>CENTRATO</b>						
	61	30	EQ.061.CP	-	EQ.061.CM	-
	71	35	EQ.071.CP	-	EQ.071.CM	-
	81	40	EQ.081.CP	-	EQ.081.CM	-
	91	45	EQ.091.CP	-	EQ.091.CM	-
	101	50	EQ.101.CP	-	EQ.101.CM	-
	121	60	EQ.121.CP	-	EQ.121.CM	-
	141	70	EQ.141.CP	-	EQ.141.CM	-
	161	80	EQ.161.CP	-	EQ.161.CM	-
	181	90			EQ.181.CM	-
	201	100			EQ.201.CM	-
<b>SINISTRA</b>						
	91	30	EQ.091.IP	-	EQ.091.IM	-
	101	35	EQ.101.IP	-	EQ.101.IM	-
	121	40	EQ.121.IP	-	EQ.121.IM	-
	141	35	EQ.141.IP	-	EQ.141.IM	-
	161	40	EQ.161.IP	-	EQ.161.IM	-
	181	45			EQ.181.IM	-
<b>DESTRA</b>						
	91	30	EQ.091.DP	-	EQ.091.DM	-
	101	35	EQ.101.DP	-	EQ.101.DM	-
	121	40	EQ.121.DP	-	EQ.121.DM	-
	141	35	EQ.141.DP	-	EQ.141.DM	-
	161	40	EQ.161.DP	-	EQ.161.DM	-
	181	45			EQ.181.DM	-
<b>DOPIO</b>						
	121	30	EQ.121.XP	-	EQ.121.XM	-
	141	35	EQ.141.XP	-	EQ.141.XM	-
	161	40	EQ.161.XP	-	EQ.161.XM	-
	181	45	EQ.181.XP	-	EQ.181.XM	-
	201	50			EQ.201.XM	-



#### MISURE SPECIALI

È possibile ordinare senza sovrapprezzo:

- Larghezze speciali. Prezzo della misura più alta.
- Altezza copertura da 5 a 10 cm.

#### FORO PER RUBINETTO E LAVABO

- È possibile ordinare il piano cottura senza foro rubinetto.

#### & complementi

Pilette e sifoni,  
Supporti da banco,  
Portasciugamani,  
Battiscopa  
paginas 292-293



LAVABI DISPONIBILI

PLUS

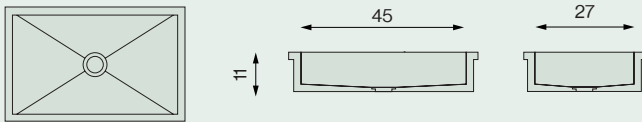

REGATA

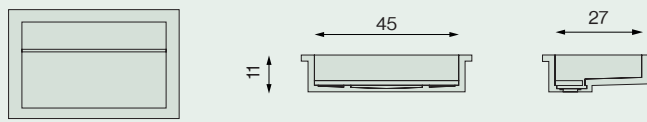

FALL

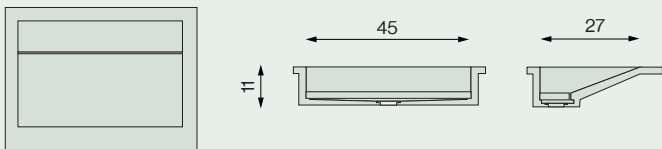

CRISTALCOLOR

Vetro ottico trasparente e vetrificato nel colore desiderato.

PERSONALIZZA E CONFIGURA LA MISURA - Scegli la misura e aggiungi il lavabo desiderato



Colori

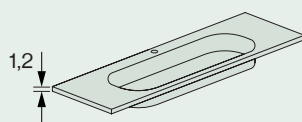

POSIZIONE LAVABO	A (cm)	E (cm)	COD	PVP
------------------	--------	--------	-----	-----

CENTRATO

	61	30	EK.061.CP	-
	71	35	EK.071.CP	-
	81	40	EK.081.CP	-
	91	45	EK.091.CP	-
	101	50	EK.101.CP	-
	121	60	EK.121.CP	-
	141	70	EK.141.CP	-
	161	80	EK.161.CP	-
	181	90	EK.181.CP	-
201	100	EK.201.CP	-	

SINISTRA

	91	30	EK.091.IP	-
	101	35	EK.101.IP	-
	121	40	EK.121.IP	-
	141	35	EK.141.IP	-
	161	40	EK.161.IP	-
	181	45	EK.181.IP	-
201	50	EK.201.IP	-	

DESTRA

	91	30	EK.091.DP	-
	101	35	EK.101.DP	-
	121	40	EK.121.DP	-
	141	35	EK.141.DP	-
	161	40	EK.161.DP	-
	181	45	EK.181.DP	-
	201	50	EK.201.DP	-

DOPPIO

	141	35	EK.141.XP	-
	161	45	EK.161.XP	-
	181	45	EK.181.XP	-
	201	50	EK.201.XP	-



MISURE SPECIALI

È possibile ordinare senza sovrapprezzo:

- Larghezze speciali. Prezzo della misura più alta.

FORO PER RUBINETTO E LAVABO

- È possibile ordinare il piano cottura senza foro rubinetto.

COLORE SPECIALE

- È possibile ordinare colori speciali nella tabella RAL.

& complementi

Pilette e sifoni, pagina 292

LAVABI DISPONIBILI

FLOW

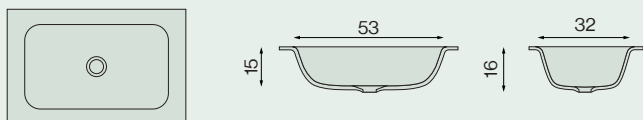

CANALE

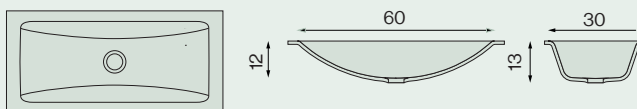

- Piani lavabo disponibili da 70 cm.
- Piano lavabo doppio non disponibile.

SEA

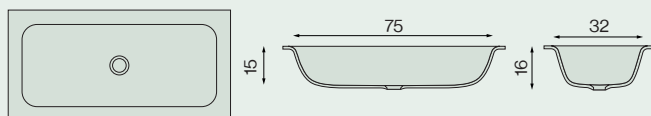

- Piani lavabo disponibili da 80 cm.
- Disponibile in doppio lavabo da 180 e 200 cm.

### CERAMICA / CERAMCOLOR

#### RECTÁNGULO



Colori



COLORE	COD	PVP
Blanco Lucido	LR.WB	-
Blanco Opaco	LR.WM	-
Negro Opaco	LR.BK	-
Tierra Opaco	LR.TR	-
Cuarzo Opaco	LR.CZ	-
Acero Opaco	LR.AC	-
Antracita Opaco	LR.AN	-
Oliva Opaco	LR.VO	-

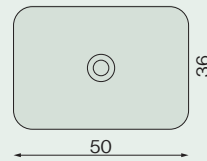

#### CUADRO



Colori



COLORE	COD	PVP
Blanco Lucido	LC.WB	-
Blanco Opaco	LC.WM	-
Negro Opaco	LC.BK	-
Tierra Opaco	LC.TR	-
Cuarzo Opaco	LCCZ	-
Acero Opaco	LC.AC	-
Antracita Opaco	LC.AN	-
Oliva Opaco	LC.VO	-

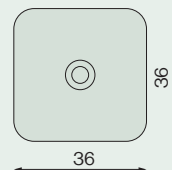

### CERAMICA / CERAMCOLOR

#### SQUARE



Colori



COLORE	COD	PVP
Blanco Lucido	LS.WB	-
Blanco Opaco	LS.WM	-
Negro Opaco	LS.BK	-
Tierra Opaco	LS.TR	-
Cuarzo Opaco	LS.CZ	-
Acero Opaco	LS.AC	-
Antracita Opaco	LS.AN	-
Oliva Opaco	LS.VO	-

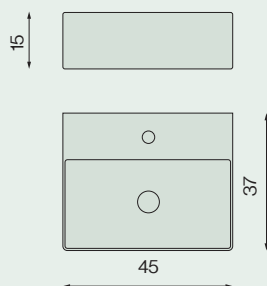

#### ÓVALO



Colori



COLORE	COD	PVP
Blanco Lucido	LV.WB	-
Blanco Opaco	LV.WM	-
Negro Opaco	LV.BK	-
Tierra Opaco	LV.TR	-
Cuarzo Opaco	LVCZ	-
Acero Opaco	LV.AC	-
Antracita Opaco	LV.AN	-
Oliva Opaco	LV.VO	-

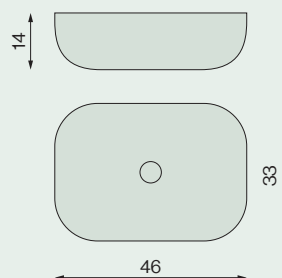

#### & complementi

Pilette e sifoni,  
Controsoffitti piatti copre  
pagina 292

### CERAMICA / CERAMCOLOR

#### CIRCUS



Colori



#### COLORE

#### COD

#### PVP

Blanco Lucido	LUWB	-
Blanco Opaco	LUWM	-
Negro Opaco	LUBK	-
Tierra Opaco	LUTR	-
Cuarzo Opaco	LUCZ	-
Acero Opaco	LUAC	-
Antracita Opaco	LUAN	-
Oliva Opaco	LUVO	-

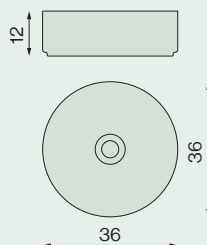

#### EYE



Colori



#### COLORE

#### COD

#### PVP

Blanco Opaco	LYWM	-
Negro Opaco	LYBK	-
Tierra Opaco	LYTR	-
Cuarzo Opaco	LYCZ	-
Acero Opaco	LYAC	-
Antracita Opaco	LYAN	-
Oliva Opaco	LYVO	-

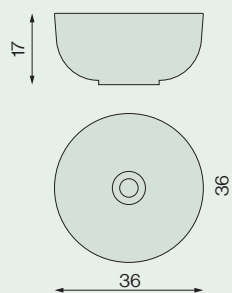

### MICROCEMENTO

#### CEMBOWL

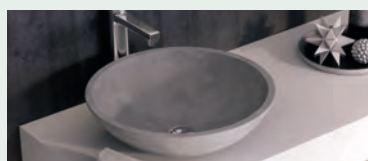

COLORE	COD	PVP
--------	-----	-----

Microcimento	LW	-
--------------	----	---

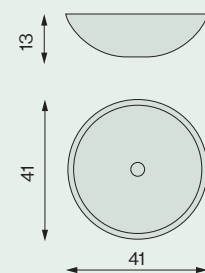

### PIETRA NATURALE

#### PIETRA

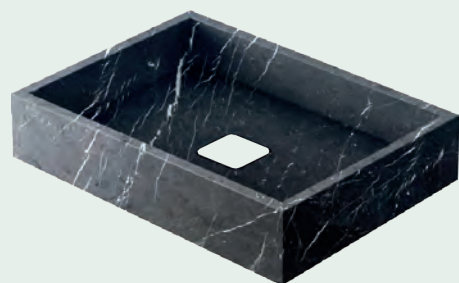

Colori

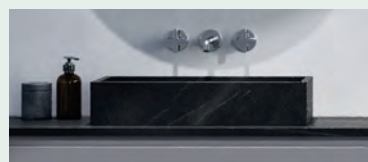
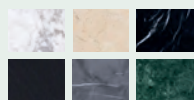

COLORE	COD	PVP
--------	-----	-----

Negro Marquina	LT.N	-
Carrara	LTC	-
Verde India	LTV	-
Negro Compacto	LT.NC	-
Crema Marfil	LT.CM	-
Pietra Gris	LT.PG	-

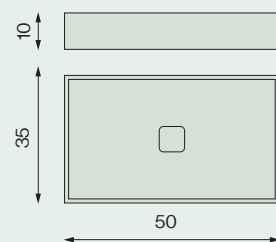

#### & complementi

Pilette e sifoni,  
Controsoffitti piatti copre  
pagina 292

SOLID SURFACE 

### PRIM



Colori

 Bianco opaco



A (cm)

COD

PVP

48	LK.048	-
58	LK.058	-

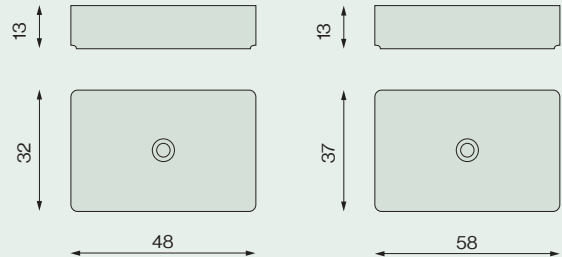

### CUADRA



Colori

 Bianco opaco



COLORE

COD

PVP

Opaco	LD	-
-------	----	---

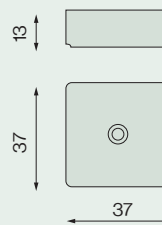

### CÍRCULO



Colori

 Bianco opaco



COLORE

COD

PVP

Opaco	LF	-
-------	----	---

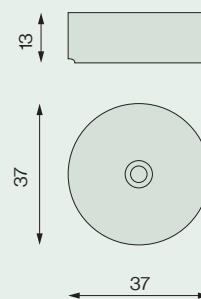



SOLID SURFACE 

### ROUND



Colori

 Bianco opaco

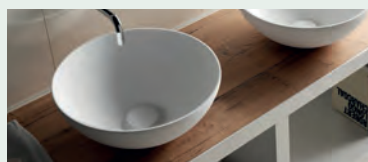

### COLORE

### COD

### PVP

Opaco

LZ

-

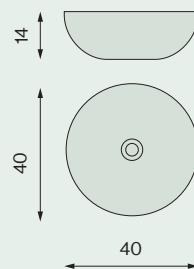

### ELIPTIC



Colori

 Bianco opaco



### COLORE

### COD

### PVP

Opaco

LH

-

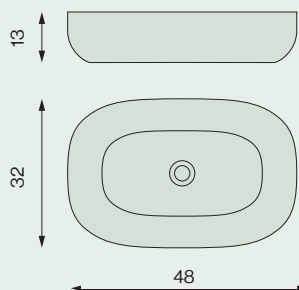

### MAX



Colori

 Bianco opaco



### COLORE

### COD

### PVP

Opaco

LA

-

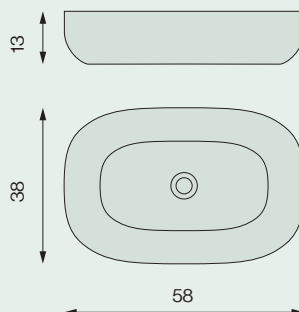

### & complementi

Pilette e sifoni,  
Controsoffitti piatti copre  
pagina 292

SOLID SURFACE  eco

COPA

COLORE

COD

PVP

Opaco

LG

-



Colori

 Bianco opaco

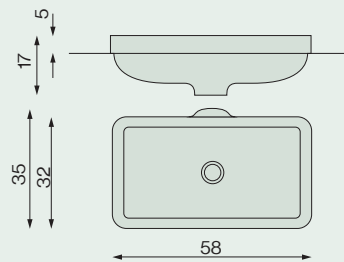

### & complementi

Pilette e sifoni,  
Controsoffitti piatti copre  
pagina 292

SOLID SURFACE 

### BALOON



#### POSIZIONE

#### COD

#### PVP

Scarico a pavimento*	TB.S	-
Scarico a muro	TB.P	-

\*include scarico e drenaggio

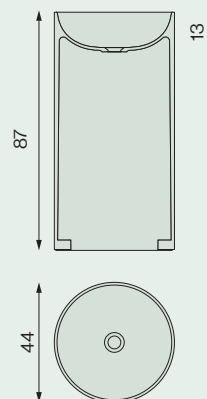

#### Colori

 Bianco opaco

### PILLAR



#### POSIZIONE

#### COD

#### PVP

Scarico a pavimento*	TL.S	-
Scarico a muro	TL.P	-

\*include scarico e drenaggio

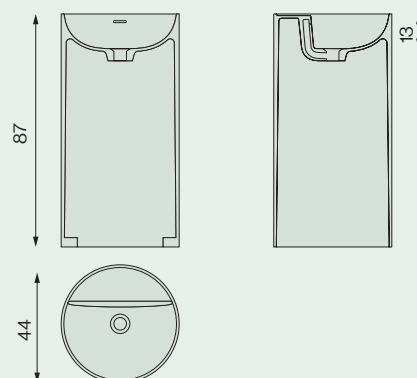

#### Colori

 Bianco opaco

### COLUMN



#### POSIZIONE

#### COD

#### PVP

Scarico a pavimento*	T.C.S	-
Scarico a muro	T.C.P	-

\*include scarico e drenaggio

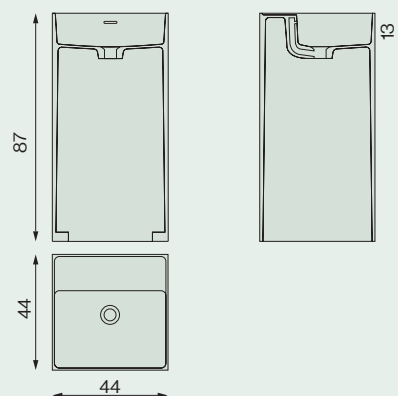

#### Colori

 Bianco opaco

LEGNO NATURE



Colori

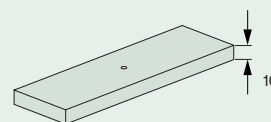
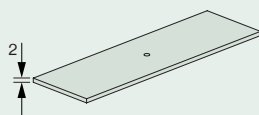
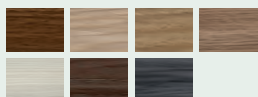

POSIZIONE LAVABO	A (cm)	E (cm)	COD	PVP	COD	PVP
------------------	--------	--------	-----	-----	-----	-----

CENTRATO

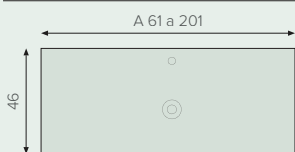

61	30	PN.061.CP	-	PN.061.CM	-
71	35	PN.071.CP	-	PN.071.CM	-
81	40	PN.081.CP	-	PN.081.CM	-
91	45	PN.091.CP	-	PN.091.CM	-
101	50	PN.101.CP	-	PN.101.CM	-
121	60	PN.121.CP	-	PN.121.CM	-
141	70	PN.141.CP	-	PN.141.CM	-
161	80	PN.161.CP	-	PN.161.CM	-
181	90	PN.181.CP	-	PN.181.CM	-
201	100	PN.201.CP	-	PN.201.CM	-

SINISTRA

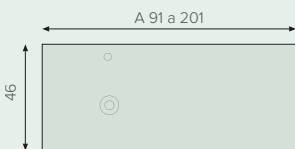

91	30	PN.091.IP	-	PN.091.IM	-
101	35	PN.101.IP	-	PN.101.IM	-
121	40	PN.121.IP	-	PN.121.IM	-
141	40	PN.141.IP	-	PN.141.IM	-
161	40	PN.161.IP	-	PN.161.IM	-
181	45	PN.181.IP	-	PN.181.IM	-
201	50	PN.201.IP	-	PN.201.IM	-

DESTRA

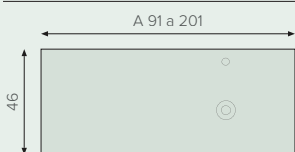

91	30	PN.091.DP	-	PN.091.DM	-
101	35	PN.101.DP	-	PN.101.DM	-
121	40	PN.121.DP	-	PN.121.DM	-
141	40	PN.141.DP	-	PN.141.DM	-
161	40	PN.161.DP	-	PN.161.DM	-
181	45	PN.181.DP	-	PN.181.DM	-
201	50	PN.201.DP	-	PN.201.DM	-

DOPPIO



121	30	PN.121.XP	-	PN.121.XM	-
141	35	PN.141.XP	-	PN.141.XM	-
161	40	PN.161.XP	-	PN.161.XM	-
181	45	PN.181.XP	-	PN.181.XM	-
201	50	PN.201.XP	-	PN.201.XM	-



MISURE SPECIALI

È possibile ordinare senza sovrapprezzo:

- Larghezze speciali. Prezzo della misura più alta.
- Profondità ridotta a 40 cm.
- Altezza copertura da 5 a 10 cm.

FORO PER RUBINETTO E LAVABO

Può essere ordinato:

- Nessun foro lavandino e / o rubinetto.
- Sifone del lavabo secondo necessità.
- Lavarozione speciale vasca fuori catalogo + € 50.

& complementi

Pilette e sifoni, Supporti da banco pagina 292

LACCA

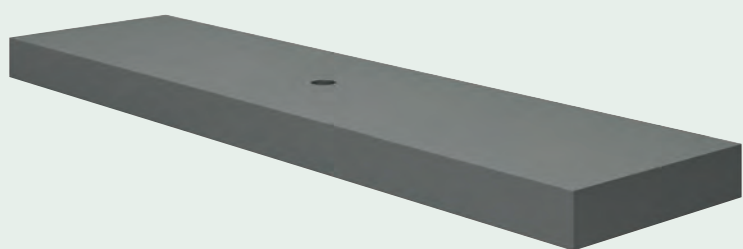
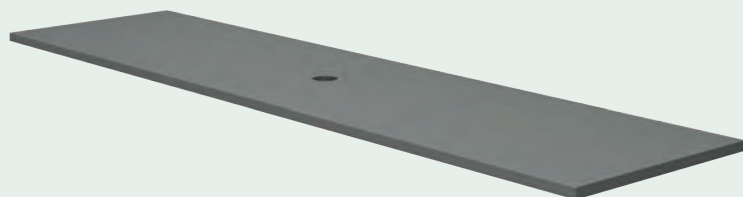

Colori

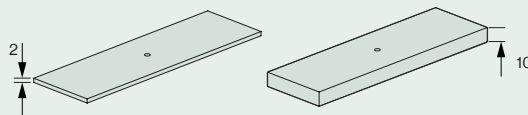

POSIZIONE LAVABO	A (cm)	E (cm)	COD	PVP	COD	PVP
<b>CENTRATO</b>						
	61	30	PL.061.CP	-	PL.061.CM	-
	71	35	PL.071.CP	-	PL.071.CM	-
	81	40	PL.081.CP	-	PL.081.CM	-
	91	45	PL.091.CP	-	PL.091.CM	-
	101	50	PL.101.CP	-	PL.101.CM	-
	121	60	PL.121.CP	-	PL.121.CM	-
	141	70	PL.141.CP	-	PL.141.CM	-
	161	80	PL.161.CP	-	PL.161.CM	-
	181	90	PL.181.CP	-	PL.181.CM	-
	201	100	PL.201.CP	-	PL.201.CM	-
<b>SINISTRA</b>						
	91	30	PL.091.IP	-	PL.091.IM	-
	101	35	PL.101.IP	-	PL.101.IM	-
	121	40	PL.121.IP	-	PL.121.IM	-
	141	40	PL.141.IP	-	PL.141.IM	-
	161	40	PL.161.IP	-	PL.161.IM	-
	181	45	PL.181.IP	-	PL.181.IM	-
<b>DESTRA</b>						
	91	30	PL.091.DP	-	PL.091.DM	-
	101	35	PL.101.DP	-	PL.101.DM	-
	121	40	PL.121.DP	-	PL.121.DM	-
	141	40	PL.141.DP	-	PL.141.DM	-
	161	40	PL.161.DP	-	PL.161.DM	-
	181	45	PL.181.DP	-	PL.181.DM	-
<b>DOPPIO</b>						
	121	30	PL.121.XP	-	PL.121.XM	-
	141	40	PL.141.XP	-	PL.141.XM	-
	161	40	PL.161.XP	-	PL.161.XM	-
	181	45	PL.181.XP	-	PL.181.XM	-
201	50	PL.201.XP	-	PL.201.XM	-	



**MISURE SPECIALI**

È possibile ordinare senza sovrapprezzo:

- Larghezze speciali. Prezzo della misura più alta.

- Profondità ridotta a 40 cm.

- Altezza copertura da 5 a 10 cm.

**FORO PER RUBINETTO E LAVABO**

Può essere ordinato:

- Nessun foro lavandino e / o rubinetto.

- Sifone del lavabo secondo necessità.

- Lavarazione speciale vasca fuori catalogo + € 50.

**& complementi**

Pilette e sifoni, Supporti da banco pagina 292

PANNELLO MULTISTRATO MARINO / Impiallacciato Rovere e Noce



Colori

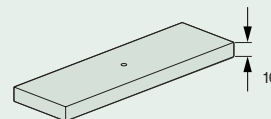
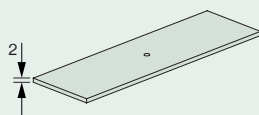
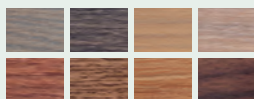

POSIZIONE LAVABO	A (cm)	E (cm)	COD	PVP	COD	PVP
<b>CENTRATO</b>						
	61	30	PT.061.CP	-	PT.061.CM	-
	71	35	PT.071.CP	-	PT.071.CM	-
	81	40	PT.081.CP	-	PT.081.CM	-
	91	45	PT.091.CP	-	PT.091.CM	-
	101	50	PT.101.CP	-	PT.101.CM	-
	121	60	PT.121.CP	-	PT.121.CM	-
	141	70	PT.141.CP	-	PT.141.CM	-
	161	80	PT.161.CP	-	PT.161.CM	-
	181	90	PT.181.CP	-	PT.181.CM	-
	201	100	PT.201.CP	-	PT.201.CM	-
<b>SINISTRA</b>						
	91	30	PT.091.IP	-	PT.091.IM	-
	101	35	PT.101.IP	-	PT.101.IM	-
	121	40	PT.121.IP	-	PT.121.IM	-
	141	40	PT.141.IP	-	PT.141.IM	-
	161	40	PT.161.IP	-	PT.161.IM	-
	181	45	PT.181.IP	-	PT.181.IM	-
<b>DESTRA</b>						
	91	30	PT.091.DP	-	PT.091.DM	-
	101	35	PT.101.DP	-	PT.101.DM	-
	121	40	PT.121.DP	-	PT.121.DM	-
	141	40	PT.141.DP	-	PT.141.DM	-
	161	40	PT.161.DP	-	PT.161.DM	-
	181	45	PT.181.DP	-	PT.181.DM	-
<b>DOPPIO</b>						
	121	30	PT.121.XP	-	PT.121.XM	-
	141	35	PT.141.XP	-	PT.141.XM	-
	161	40	PT.161.XP	-	PT.161.XM	-
	181	45	PT.181.XP	-	PT.181.XM	-
201	50	PT.201.XP	-	PT.201.XM	-	



**MISURE SPECIALI**

È possibile ordinare senza sovrapprezzo:

- Larghezze speciali. Prezzo della misura più alta.

- Profondità ridotta a 40 cm.

- Altezza copertura da 5 a 10 cm.

**FORO PER RUBINETTO E LAVABO**

Può essere ordinato:

- Nessun foro lavandino e / o rubinetto.

- Sifone del lavabo secondo necessità.

- Lavarazione speciale vasca fuori catalogo + € 50

**& complementi**

Pilette e sifoni, Supporti da banco pagina 292

### LEGNO ROVERE MASSELLO



#### Colori

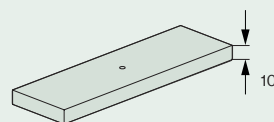
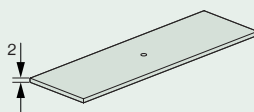
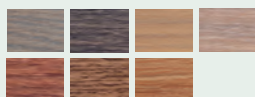

POSIZIONE LAVABO	A (cm)	E (cm)	COD	PVP	COD	PVP
<b>CENTRATO</b>						
	61	30	PZ.061.CP	-	PZ.061.CM	-
	71	35	PZ.071.CP	-	PZ.071.CM	-
	81	40	PZ.081.CP	-	PZ.081.CM	-
	91	45	PZ.091.CP	-	PZ.091.CM	-
	101	50	PZ.101.CP	-	PZ.101.CM	-
	121	60	PZ.121.CP	-	PZ.121.CM	-
	141	70	PZ.141.CP	-	PZ.141.CM	-
	161	80	PZ.161.CP	-	PZ.161.CM	-
	181	90	PZ.181.CP	-	PZ.181.CM	-
	201	100	PZ.201.CP	-	PZ.201.CM	-
<b>SINISTRA</b>						
	91	30	PZ.091.IP	-	PZ.091.IM	-
	101	35	PZ.101.IP	-	PZ.101.IM	-
	121	40	PZ.121.IP	-	PZ.121.IM	-
	141	40	PZ.141.IP	-	PZ.141.IM	-
	161	40	PZ.161.IP	-	PZ.161.IM	-
	181	45	PZ.181.IP	-	PZ.181.IM	-
<b>DESTRA</b>						
	91	30	PZ.091.DP	-	PZ.091.DM	-
	101	35	PZ.101.DP	-	PZ.101.DM	-
	121	40	PZ.121.DP	-	PZ.121.DM	-
	141	40	PZ.141.DP	-	PZ.141.DM	-
	161	40	PZ.161.DP	-	PZ.161.DM	-
	181	45	PZ.181.DP	-	PZ.181.DM	-
<b>DOPPIO</b>						
	121	30	PZ.121.XP	-	PZ.121.XM	-
	141	35	PZ.141.XP	-	PZ.141.XM	-
	161	40	PZ.161.XP	-	PZ.161.XM	-
	181	45	PZ.181.XP	-	PZ.181.XM	-
201	50	PZ.201.XP	-	PZ.201.XM	-	



#### MISURE SPECIALI

È possibile ordinare senza sovrapprezzo:

- Larghezze speciali. Prezzo della misura più alta.
- Profondità ridotta a 40 cm.
- Altezza copertura da 5 a 10 cm.

#### FORO PER RUBINETTO E LAVABO

Può essere ordinato:

- Nessun foro lavandino e / o rubinetto.
- Sifone del lavabo secondo necessità.
- Lavarazione speciale vasca fuori catalogo + € 50

#### & complementi

Pilette e sifoni, Supporti da banco pagina 292

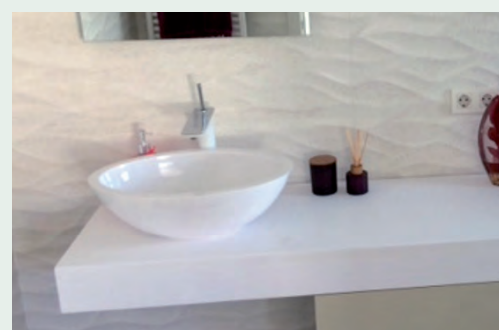

SOLID MINERAL

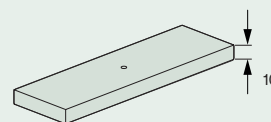
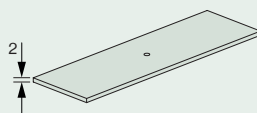

Colori

 Bianco opaco

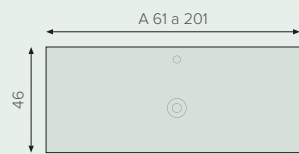
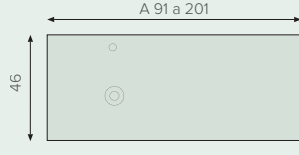
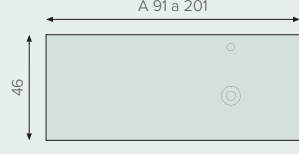

POSIZIONE LAVABO	A (cm)	E (cm)	COD	PVP	COD	PVP
<b>CENTRATO</b>						
	<b>61</b>	30	PS.061.CP	-	PS.061.CM	-
	<b>71</b>	35	PS.071.CP	-	PS.071.CM	-
	<b>81</b>	40	PS.081.CP	-	PS.081.CM	-
	<b>91</b>	45	PS.091.CP	-	PS.091.CM	-
	<b>101</b>	50	PS.101.CP	-	PS.101.CM	-
	<b>121</b>	60	PS.121.CP	-	PS.121.CM	-
	<b>141</b>	70	PS.141.CP	-	PS.141.CM	-
	<b>161</b>	80	PS.161.CP	-	PS.161.CM	-
	<b>181</b>	90	PS.181.CP	-	PS.181.CM	-
	<b>201</b>	100	PS.201.CP	-	PS.201.CM	-
<b>SINISTRA</b>						
	<b>91</b>	30	PS.091.IP	-	PS.091.IM	-
	<b>101</b>	35	PS.101.IP	-	PS.101.IM	-
	<b>121</b>	40	PS.121.IP	-	PS.121.IM	-
	<b>141</b>	40	PS.141.IP	-	PS.141.IM	-
	<b>161</b>	40	PS.161.IP	-	PS.161.IM	-
	<b>181</b>	45	PS.181.IP	-	PS.181.IM	-
<b>DESTRA</b>						
	<b>91</b>	30	PS.091.DP	-	PS.091.DM	-
	<b>101</b>	35	PS.101.DP	-	PS.101.DM	-
	<b>121</b>	40	PS.121.DP	-	PS.121.DM	-
	<b>141</b>	40	PS.141.DP	-	PS.141.DM	-
	<b>161</b>	40	PS.161.DP	-	PS.161.DM	-
	<b>181</b>	45	PS.181.DP	-	PS.181.DM	-
<b>DOPPIO</b>						
	<b>121</b>	30	PS.121.XP	-	PS.121.XM	-
	<b>141</b>	35	PS.141.XP	-	PS.141.XM	-
	<b>161</b>	40	PS.161.XP	-	PS.161.XM	-
	<b>181</b>	45	PS.181.XP	-	PS.181.XM	-
<b>201</b>	50	PS.201.XP	-	PS.201.XM	-	



**MISURE SPECIALI**

È possibile ordinare senza sovrapprezzo:

- Larghezze speciali. Prezzo della misura più alta.
- Profondità ridotta a 40 cm.
- Altezza copertura da 5 a 10 cm.

**FORO PER RUBINETTO E LAVABO**

Può essere ordinato:

- Nessun foro lavandino e / o rubinetto.
- Sifone del lavabo secondo necessità.
- Lavazione speciale vasca fuori catalogo + € 50

**& complementi**

Pilette e sifoni, supporti da banco, portasciugamani, battiscopa da appoggio pagine 292-293



SOLID SURFACE 

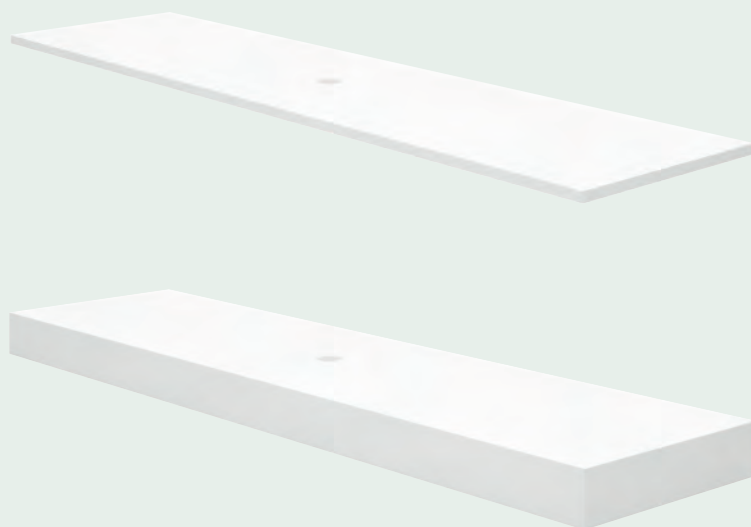

03 PIANI LAVABO

Colori

 Bianco opaco

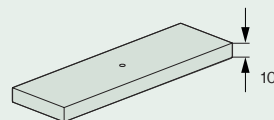
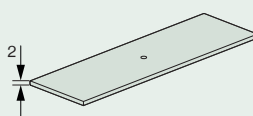

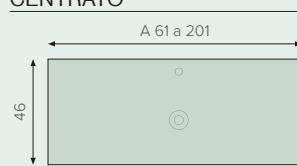
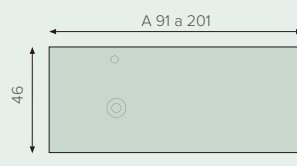
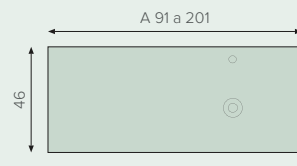
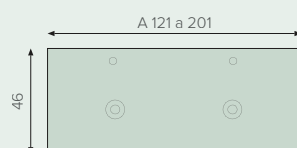
POSIZIONE LAVABO	A (cm)	E (cm)	COD	PVP	COD	PVP
<b>CENTRATO</b>						
	<b>61</b>	30	PJ.061.CP	-	PJ.061.CM	-
	<b>71</b>	35	PJ.071.CP	-	PJ.071.CM	-
	<b>81</b>	40	PJ.081.CP	-	PJ.081.CM	-
	<b>91</b>	45	PJ.091.CP	-	PJ.091.CM	-
	<b>101</b>	50	PJ.101.CP	-	PJ.101.CM	-
	<b>121</b>	60	PJ.121.CP	-	PJ.121.CM	-
	<b>141</b>	70	PJ.141.CP	-	PJ.141.CM	-
	<b>161</b>	80	PJ.161.CP	-	PJ.161.CM	-
	<b>181</b>	90	PJ.181.CP	-	PJ.181.CM	-
	<b>201</b>	100	PJ.201.CP	-	PJ.201.CM	-
<b>SINISTRA</b>						
	<b>91</b>	30	PJ.091.IP	-	PJ.091.IM	-
	<b>101</b>	35	PJ.101.IP	-	PJ.101.IM	-
	<b>121</b>	40	PJ.121.IP	-	PJ.121.IM	-
	<b>141</b>	40	PJ.141.IP	-	PJ.141.IM	-
	<b>161</b>	40	PJ.161.IP	-	PJ.161.IM	-
	<b>181</b>	45	PJ.181.IP	-	PJ.181.IM	-
<b>DESTRA</b>						
	<b>91</b>	30	PJ.091.DP	-	PJ.091.DM	-
	<b>101</b>	35	PJ.101.DP	-	PJ.101.DM	-
	<b>121</b>	40	PJ.121.DP	-	PJ.121.DM	-
	<b>141</b>	40	PJ.141.DP	-	PJ.141.DM	-
	<b>161</b>	40	PJ.161.DP	-	PJ.161.DM	-
	<b>181</b>	45	PJ.181.DP	-	PJ.181.DM	-
<b>DOPPIO</b>						
	<b>121</b>	30	PJ.121.XP	-	PJ.121.XM	-
	<b>141</b>	40	PJ.141.XP	-	PJ.141.XM	-
	<b>161</b>	40	PJ.161.XP	-	PJ.161.XM	-
	<b>181</b>	45	PJ.181.XP	-	PJ.181.XM	-
	<b>201</b>	50	PJ.201.XP	-	PJ.201.XM	-



### MISURE SPECIALI

È possibile ordinare senza sovrapprezzo:

- Larghezze speciali. Prezzo della misura più alta.
- Profondità ridotta a 40 cm.
- Altezza copertura da 5 a 10 cm.

### FORO PER RUBINETTO E LAVABO

Può essere ordinato:

- Nessun foro lavandino e / o rubinetto.
- Sifone del lavabo secondo necessità.
- Lavaggio speciale vasca fuori catalogo + € 50

### & complementi

Pilette e sifoni, supporti da banco, portasciugamani, battiscopa  
pagine 292-293

CERAMCOLOR

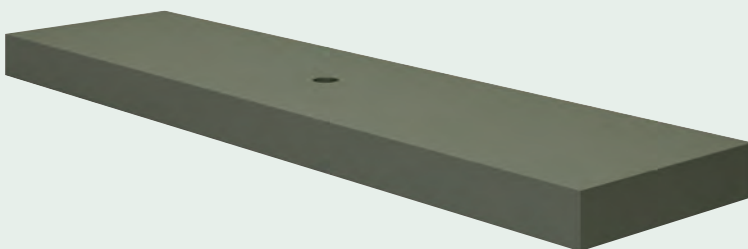
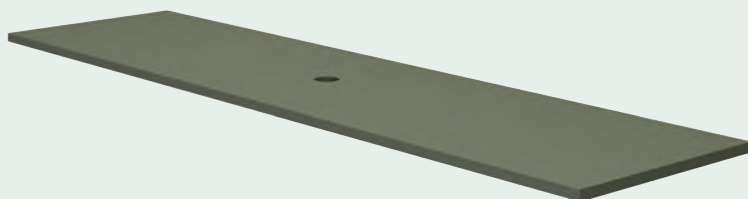

Colori Opaco

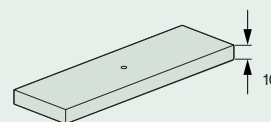
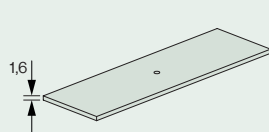

POSIZIONE LAVABO	A (cm)	E (cm)	COD	PVP	COD	PVP
<b>CENTRATO</b>						
	A 61 a 201					
	61	30	PC.061.CP	-	PC.061.CM	-
	71	35	PC.071.CP	-	PC.071.CM	-
	81	40	PC.081.CP	-	PC.081.CM	-
	91	45	PC.091.CP	-	PC.091.CM	-
	101	50	PC.101.CP	-	PC.101.CM	-
	121	60	PC.121.CP	-	PC.121.CM	-
	141	70	PC.141.CP	-	PC.141.CM	-
	161	80	PC.161.CP	-	PC.161.CM	-
181	90	PC.181.CP	-	PC.181.CM	-	
201	100	PC.201.CP	-	PC.201.CM	-	
<b>SINISTRA</b>						
	A 91 a 201					
	91	30	PC.091.IP	-	PC.091.IM	-
	101	35	PC.101.IP	-	PC.101.IM	-
	121	40	PC.121.IP	-	PC.121.IM	-
	141	40	PC.141.IP	-	PC.141.IM	-
	161	40	PC.161.IP	-	PC.161.IM	-
	181	45	PC.181.IP	-	PC.181.IM	-
201	50	PC.201.IP	-	PC.201.IM	-	
<b>DESTRA</b>						
	A 91 a 201					
	91	30	PC.091.DP	-	PC.091.DM	-
	101	35	PC.101.DP	-	PC.101.DM	-
	121	40	PC.121.DP	-	PC.121.DM	-
	141	40	PC.141.DP	-	PC.141.DM	-
	161	40	PC.161.DP	-	PC.161.DM	-
	181	45	PC.181.DP	-	PC.181.DM	-
201	50	PC.201.DP	-	PC.201.DM	-	
<b>DOPPIO</b>						
	A 121 a 201					
	121	30	PC.121.XP	-	PC.121.XM	-
	141	35	PC.141.XP	-	PC.141.XM	-
	161	40	PC.161.XP	-	PC.161.XM	-
	181	45	PC.181.XP	-	PC.181.XM	-
201	50	PC.201.XP	-	PC.201.XM	-	



**MISURE SPECIALI**

È possibile ordinare senza sovrapprezzo:

- Larghezze speciali. Prezzo della misura più alta.
- Profondità ridotta a 40 cm.
- Altezza copertura da 5 a 10 cm.

**FORO PER RUBINETTO E LAVABO**

- Può essere ordinato:
- Nessun foro lavandino e / o rubinetto
  - Sifone del lavabo secondo necessità.
  - Lavarazione speciale vasca fuori catalogo + € 50

**& complementi**

Pilette e sifoni, supporti da banco, pagina 292

PIETRA NATURALE

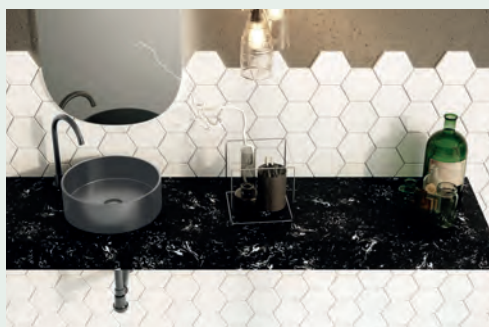
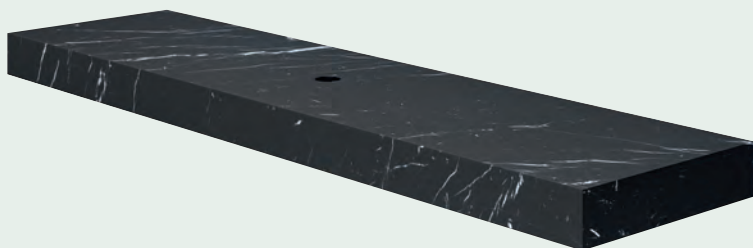
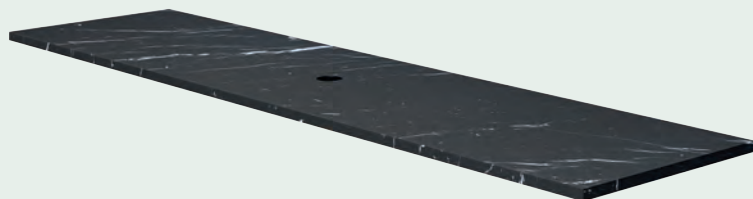

Colori

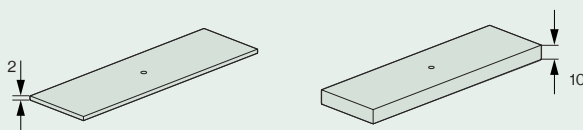
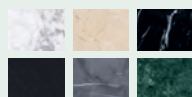

POSIZIONE LAVABO	A (cm)	E (cm)	COD	PVP	COD	PVP
<b>CENTRATO</b>						
	61	30	PQ.061.CP	-	PQ.061.CM	-
	71	35	PQ.071.CP	-	PQ.071.CM	-
	81	40	PQ.081.CP	-	PQ.081.CM	-
	91	45	PQ.091.CP	-	PQ.091.CM	-
	101	50	PQ.101.CP	-	PQ.101.CM	-
	121	60	PQ.121.CP	-	PQ.121.CM	-
	141	70	PQ.141.CP	-	PQ.141.CM	-
	161	80	PQ.161.CP	-	PQ.161.CM	-
	181	90			PQ.181.CM	-
	201	100			PQ.201.CM	-
<b>SINISTRA</b>						
	91	30	PQ.091.IP	-	PQ.091.IM	-
	101	35	PQ.101.IP	-	PQ.101.IM	-
	121	40	PQ.121.IP	-	PQ.121.IM	-
	141	40	PQ.141.IP	-	PQ.141.IM	-
	161	40	PQ.161.IP	-	PQ.161.IM	-
	181	45			PQ.181.IM	-
<b>DESTRA</b>						
	91	30	PQ.091.DP	-	PQ.091.DM	-
	101	35	PQ.101.DP	-	PQ.101.DM	-
	121	40	PQ.121.DP	-	PQ.121.DM	-
	141	40	PQ.141.DP	-	PQ.141.DM	-
	161	40	PQ.161.DP	-	PQ.161.DM	-
	181	45			PQ.181.DM	-
<b>DOPPIO</b>						
	121	30	PQ.121.XP	-	PQ.121.XM	-
	141	40	PQ.141.XP	-	PQ.141.XM	-
	161	40	PQ.161.XP	-	PQ.161.XM	-
	181	45	PQ.181.XP	-	PQ.181.XM	-
	201	50			PQ.201.XM	-



**MISURE SPECIALI**

È possibile ordinare senza sovrapprezzo:

- Larghezze speciali. Prezzo della misura più alta.
- Profondità ridotta a 40 cm.
- Altezza copertura da 5 a 10 cm.

**FORO PER RUBINETTO E LAVABO**

Può essere ordinato:

- Nessun foro lavandino e / o rubinetto.
- Sifone del lavabo secondo necessità.
- Lavarazione speciale vasca fuori catalogo + € 50

**& complementi**

Pilette e sifoni, supporti da banco mural, portasciugamani, controsoffitto pagine 292-293

### SUPPORTI A PARETE

#### SUPPORTI DI FISSAGGIO PER PIANI LAVABO A PARETE



1 unità

150 Kg di carico

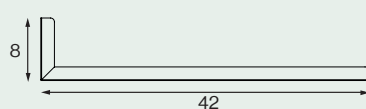

COD	PVP
CE01	-

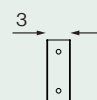

Colori



### PILETTE

#### PILETTE CLASSICHE



COLORE	COD	PVP
Cromo lucido	CE02	-
Bianco opaco	CE03	-
Nero opaco	CE04	-

Non compatibile con il Sistema Decospace

Colori



#### PILETTE CERAMCOLOR



COLORE	COD	PVP
Blanco Opaco	CE05	-
Negro Opaco	CE06	-
Antracita Opaco	CE07	-
Tierra Opaco	CE08	-

Non compatibile con il Sistema Decospace

Colori



#### PILETTE SOLID



MATERIALE	COD	PVP
Solid Mineral	CE09	-
Solid Surface	CE10	-

Non compatibile con il Sistema Decospace

Colori



#### FINITURE PER PILETTE DECOSPACE



COLORE	COD	PVP
Bianco opaco	CE11	-
Nero opaco	CE12	-
Oro lucido	CE13	-

Colori



SIFONI DECORATIVI

SIFONI DECORATIVI



COLORE	COD	PVP
Cromo lucido	CE14	-
Bianco opaco	CE15	-
Nero opaco	CE16	-

Colori



ASCIUGAMANI

PORTA ASCIUGAMANI ANTERIORE (INTEGRATO)



MATERIALE	COD	PVP
Pietra Naturale	CE17	-
Solid Mineral	CE18	-
Solid Surface	CE19	-

Colori Pietra

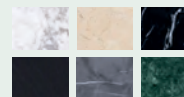

Colori



PORTA ASCIUGAMANI

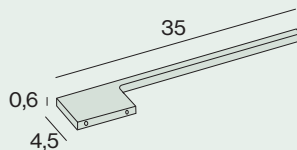

COLORE	COD	PVP
Cromo lucido	CM8.CB	-
Nero opaco	CM8.BK	-
Colore (lettera laccata)	CM8.CO	-

Colori



Colori Laccati



ALZATINA PER MOBILE



A(cm)	SOLID MINERAL		SOLID SURFACE		PIETRA NATURALE	
	COD	PVP (metro lineare)	COD	PVP (metro lineare)	COD	PVP (metro lineare)
Da 40 a 100	CE20	-	CE23	-	CE26	-
Da 100 a 160	CE21	-	CE24	-	CE27	-
Da 160 a 200	CE22	-	CE25	-	CE28	-

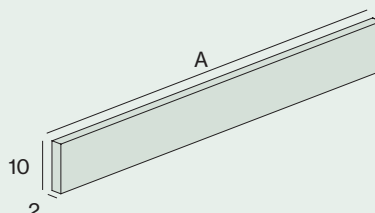

Colori Pietra

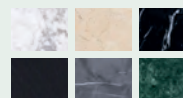

Colori







# 04 Specchi

La fusione dello specchio con la migliore tecnologia LED unisce specchi lisci, smussati e a incasso di diversi formati per dare soluzione ad ogni progetto.

**LISCIO**

Ampia gamma di specchi essenziali con bordi lucidi.

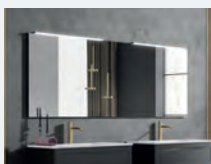

**Rettangolare Liscio**

pag. 300

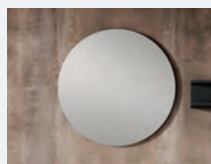

**Round Liscio**

pag. 300

**RETROILLUMINAZIONE**

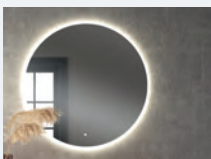

**Rounded**

pag. 301

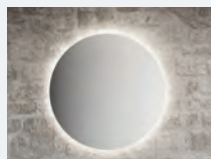

**Circled**

pag. 301



**Retroled**

pag. 302

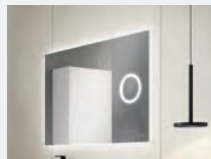

**Filed**

pag. 302



**Spinled**

pag. 303

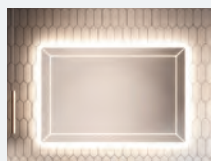

**Frameled**

pag. 303

**RETROILLUMINAZIONE ANTERIORE**

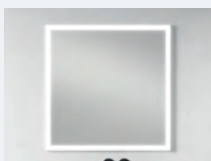

**Fronled**

pag. 304

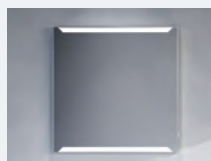

**Duoled**

pag. 304

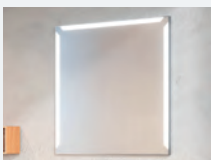

**Triled**

pag. 305

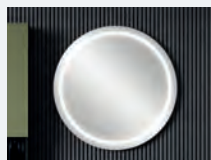

**Eyeled**

pag. 305



**CORNICI IN METALLO**



**Metalrounded**

pag. 306



**Metalsquareled**

pag. 306

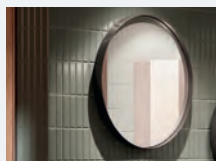

**Metalround**

pag. 307



**Metalsquare**

pag. 307

**CORNICI IN LEGNO**

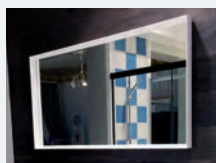

**Corner**

pag. 308

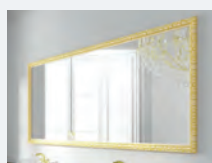

**Luxor**

pag. 308

**ARMADI A SPECCHIO**

Armadio con ante di grande capienza e funzionalità, totalmente rivestite a specchio.



**Armadio a specchio un'anta**

pag. 309



**Armadio a specchio a due ante**

pag. 309

**COMPLETA IL TUO SPECCHIO**

Personalizza il tuo specchio con opzioni come antiappannamento, sensori, luci.

pag. 310

Ciascuna delle soluzioni può essere personalizzata.

I nostri prodotti sono certificati e conformi alla certificazione CE e IP44 nel caso di specchi retroilluminati.

Tutti gli specchi hanno uno spessore di 4 mm con bordi lucidi e vengono forniti con il kit di fissaggio necessario per il loro posizionamento con ganci regolabili.

Gli specchi lisci hanno finiture laterali rifinite in cromo lucido e una schiuma antishock che permette un perfetto adattamento alla parete e previene le vibrazioni dello specchio.

Gli specchi lisci possono essere dotati del SISTEMA SICURO, che fornisce una sicurezza extra che impedisce a un pezzo di cadere in caso di rottura.

Specchi con illuminazione a led.

Consultare la pagina relativa alle informazioni tecniche sull'illuminazione pag. 317.

## Scopri le diverse opzioni che la maggior parte degli specchi ti offre



### SPECCHIO ANTI APPANNAMENTO

È possibile dotare lo specchio di un sistema anti appannamento. Una lamina termica aderisce alla parte posteriore dello specchio e evitando la condensa dell'acqua sullo specchio, migliorando il comfort di utilizzo e il perfetto riflesso di quest'ultimo.



### SPECCHI CON LUCE FREDDA E / O CALDA

Puoi personalizzare il tuo specchio con la temperatura del colore che desideri, più calda o più fredda, da 2700°k a 5500°K. Puoi persino dotare il tuo specchio di un sensore tattile che ti permetterà di modificare la temperatura del colore, che sia caldo, neutro o freddo.



### SPECCHI CON SENSORE ACCESO SPENTO

Questa opzione ti consentirà di accendere / spegnere lo specchio e modificare l'intensità della luce se necessario con una leggera pressione sul sensore tattile.



### SPECCHI CON SCREEN MIRROR

La tecnologia ci consente di riprodurre lo schermo del tuo cellulare sullo specchio. Con questo, puoi facilmente riprodurre tutti i contenuti nello specchio dal tuo cellulare come video e foto. Compatibile con IOS e Android.



### SPECCHI CON BLUETOOTH

Puoi collegare il tuo cellulare allo specchio tramite bluetooth e goderti la tua musica in bagno.



### SENSORE ANTIAPPANNAMENTO

Sensore ON/OFF per sistema antiappannamento.



### SPECCHI INGRANDENTI X5 LED

Puoi personalizzare il tuo specchio con uno specchio ingrandente x5 con LED integrato.

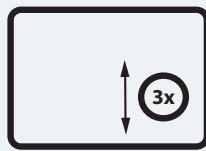

### SPECCHI INGRANDENTI MOBILI

È possibile dotare lo specchio di uno specchio magnetizzato x3 che consente il posizionamento nella zona destra dello specchio e regolarne la posizione in altezza o riporlo nel mobile.

**RETTANGOLARE LISCIO: Standard e misurato**

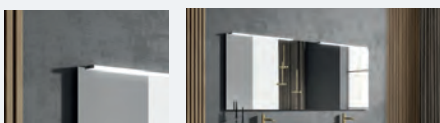

- Standard base: con piastra da appendere.
- Standard garantito: specchio con sistema di sicurezza e protezioni laterali antishock
- Personalizzato: specchio a misura con sistema di sicurezza e protezioni laterali antishock.

TIPI	A (cm)	H (cm)	COD	PVP
<b>Standard di base</b>				
60	80	80	SLB.06080	-
70	80	80	SLB.07080	-
80	80	80	SLB.08080	-
90	80	80	SLB.09080	-
100	80	80	SLB.10080	-
120	80	80	SLB.12080	-
140	80	80	SLB.14080	-
<b>Standard garantito</b>				
60	80	80	SLS.06080	-
70	80	80	SLS.07080	-
80	80	80	SLS.08080	-
90	80	80	SLS.09080	-
100	80	80	SLS.10080	-
120	80	80	SLS.12080	-
140	80	80	SLS.14080	-
<b>Personalizzato sicuro</b>				
60 a 80	50 a 90	50 a 90	SLM.08090	-
81 a 100	50 a 90	50 a 90	SLM.10090	-
101 a 120	50 a 90	50 a 90	SLM.12090	-
121 a 140	50 a 90	50 a 90	SLM.14090	-
141 a 160	50 a 90	50 a 90	SLM.16090	-
161 a 180	50 a 90	50 a 90	SLM.18090	-
181 a 200	50 a 90	50 a 90	SLM.20090	-
40 a 60	150 a 200	150 a 200	SLM.040200	-

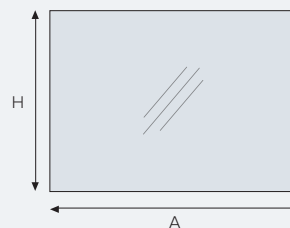

**& complementi**  
 Sistema antiappannamento,  
 Sensore antiappannamento,  
 Led 5X  
 Pag.....310

**ROUND LISCIO: Specchio tondo liscio standard**

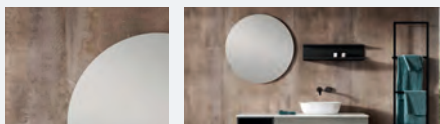

- Appendini regolabili

D (cm)	COD	PVP
60	SR.06060	-
70	SR.07070	-
80	SR.08080	-
90	SR.09090	-
100	SR.100100	-
120	SR.120120	-

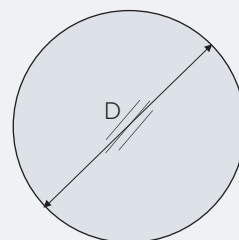

### ROUNDLED: Retroilluminazione laterale e cornice perimetrale

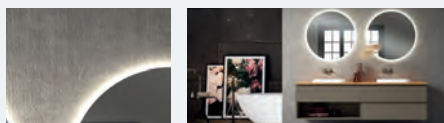

LUCE	COLORE °K	CONSUMO	ENERGIA	TENUTA
LED	5500K Bianca	9.6W	960 LUMENS metro lineare	IP44

▲ Personalizza il tuo LED a 3000°K e 4200°K senza costi aggiuntivi. Standard de 5500°K.

D (cm)	COD	PVP
60	SD.6060	-
80	SD.8080	-

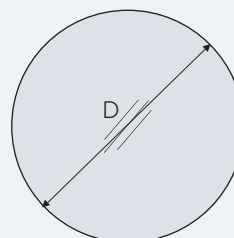

#### & complementi

Sensore On/Off,  
Sensore antiappannamento,  
Sistema antiappannamento  
Pag....310

### CIRCLED: Retroilluminazione perimetrale

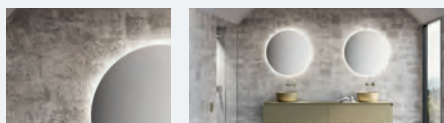

LUCE	COLORE °K	CONSUMO	ENERGIA	TENUTA
LED	5500K Bianca	9.6W	960 LUMENS metro lineare	IP44

▲ Personalizza il tuo LED a 3000°K e 4200°K senza costi aggiuntivi. Standard de 5500°K.

D (cm)	COD	PVP
60	SC.06060	-
70	SC.07070	-
80	SC.08080	-
90	SC.09090	-
100	SC.100100	-

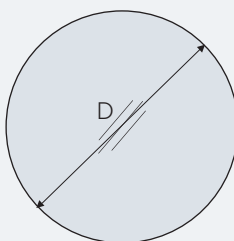

#### & complementi

Sensore On/Off,  
Sensore antiappannamento,  
Sistema antiappannamento  
Pag.....310

### RETROLED: Retroilluminazione superiore e inferiore

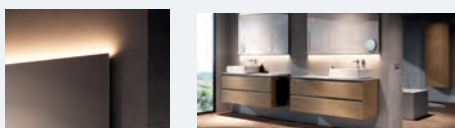

Standard y a medida

LUCE	COLORE °K	CONSUMO	ENERGIA	TENUTA
LED	5500K Bianca	9.6W	960 LUMENS metro lineare	IP44

Personalizza il tuo LED a 3000°K e 4200°K senza costi aggiuntivi. Standard de 5500°K.

TIPI	A (cm)	H (cm)	COD	PVP
<b>Standard</b>				
60	80	80	ST.06080	-
80	80	80	ST.08080	-
100	80	80	ST.10080	-
120	80	80	ST.12080	-
140	80	80	ST.14080	-
<b>Su misura</b>				
60 a 80	50 a 72	50 a 72	ST.08072	-
81 a 100	50 a 72	50 a 72	ST.10072	-
101 a 120	50 a 72	50 a 72	ST.12072	-
121 a 140	50 a 72	50 a 72	ST.14072	-
141 a 160	50 a 72	50 a 72	ST.16072	-
161 a 180	50 a 72	50 a 72	ST.18072	-
181 a 200	50 a 72	50 a 72	ST.20072	-
60 a 80	73 a 90	73 a 90	ST.08090	-
81 a 100	73 a 90	73 a 90	ST.10090	-
101 a 120	73 a 90	73 a 90	ST.12090	-
121 a 140	73 a 90	73 a 90	ST.14090	-
141 a 160	73 a 90	73 a 90	ST.16090	-
161 a 180	73 a 90	73 a 90	ST.18090	-
181 a 200	73 a 90	73 a 90	ST.20090	-

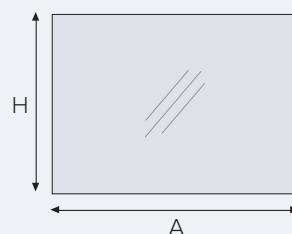

#### & complementi

Sistema antiappannamento,  
Led 5X,  
Sensore On/Off,  
Sensore di colore,  
Sensore Bluetooth,  
Sensore Screen,  
Pagine.....310-312

### FILED : Retroilluminazione e cornice perimetrale

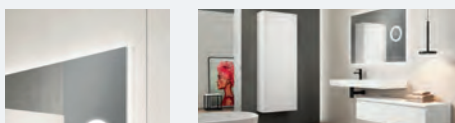
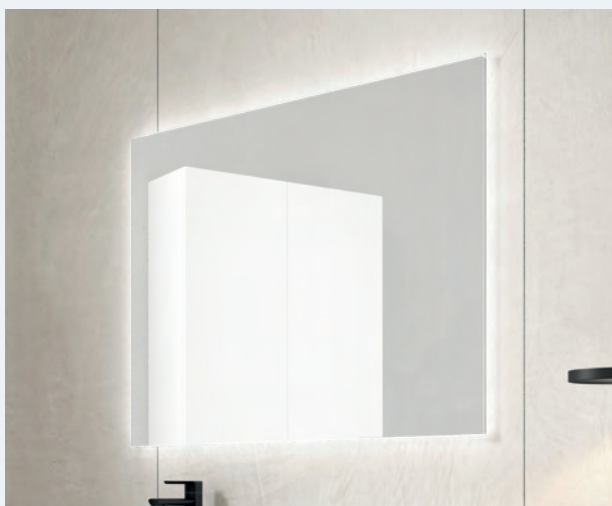

LUCE	COLORE °K	CONSUMO	ENERGIA	TENUTA
LED	5500K Bianca	9.6W	960 LUMENS metro lineare	IP44

Personalizza il tuo LED a 3000°K e 4200°K senza costi aggiuntivi. Standard de 5500°K.

TIPI	A (cm)	H (cm)	COD	PVP
<b>Standard</b>				
60	80	80	SF.06080	-
80	80	80	SF.08080	-
100	80	80	SF.10080	-
120	80	80	SF.12080	-
140	80	80	SF.14080	-
<b>Su misura</b>				
60 a 80	50 a 72	50 a 72	SF.08072	-
81 a 100	50 a 72	50 a 72	SF.10072	-
101 a 120	50 a 72	50 a 72	SF.12072	-
121 a 140	50 a 72	50 a 72	SF.14072	-
141 a 160	50 a 72	50 a 72	SF.16072	-
161 a 180	50 a 72	50 a 72	SF.18072	-
181 a 200	50 a 72	50 a 72	SF.20072	-
60 a 80	73 a 90	73 a 90	SF.08090	-
81 a 100	73 a 90	73 a 90	SF.10090	-
101 a 120	73 a 90	73 a 90	SF.12090	-
121 a 140	73 a 90	73 a 90	SF.14090	-
141 a 160	73 a 90	73 a 90	SF.16090	-
161 a 180	73 a 90	73 a 90	SF.18090	-
181 a 200	73 a 90	73 a 90	SF.20090	-

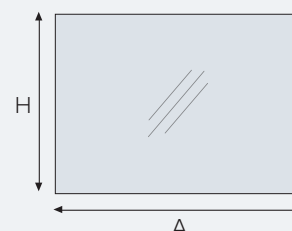

#### & complementi

Sistema antiappannamento,  
Led 5X,  
Sensore On/Off,  
Sensore di colore,  
Sensore Bluetooth,  
Sensore Screen,  
Pagine.....310-312

### SPINLED: Retroilluminazione perimetrale

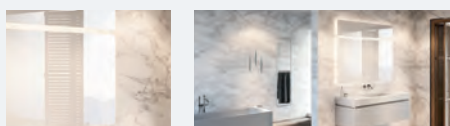

LUCE	COLORE °K	CONSUMO	ENERGIA	TENUTA
LED	5500K Bianca	9.6W	960 LUMENS metro lineare	IP44

Personalizza il tuo LED a 3000°K e 4200°K senza costi aggiuntivi. Standard de 5500°K.

TIPI	A (cm)	H (cm)	COD	PVP
<b>Standard</b>				
	60	80	SP.06080	-
	80	80	SP.08080	-
	100	80	SP.10080	-
	120	80	SP.12080	-
	140	80	SP.14080	-
<b>Su misura</b>				
	60 a 80	50 a 72	SP.08072	-
	81 a 100	50 a 72	SP.10072	-
	101 a 120	50 a 72	SP.12072	-
	121 a 140	50 a 72	SP.14072	-
	141 a 160	50 a 72	SP.16072	-
	161 a 180	50 a 72	SP.18072	-
	181 a 200	50 a 72	SP.20072	-
	60 a 80	73 a 90	SP.08090	-
	81 a 100	73 a 90	SP.10090	-
	101 a 120	73 a 90	SP.12090	-
	121 a 140	73 a 90	SP.14090	-
	141 a 160	73 a 90	SP.16090	-
	161 a 180	73 a 90	SP.18090	-
	181 a 200	73 a 90	SP.20090	-

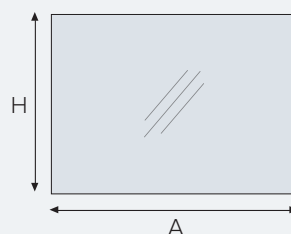

#### & complementi

Sistema antiappannamento,  
Led 5X,  
Sensore On/Off,  
Sensore di colore,  
Sensore Bluetooth,  
Sensore Screen,  
Pagine.....310-312

### FRAMELED: Retroilluminazione perimetrale e Led frontale

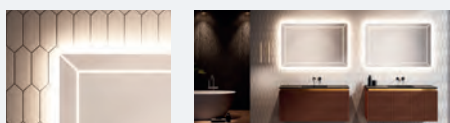

Il sensore spegne e accende la luce. Led perimetrale e frontale

LUCE	COLORE °K	CONSUMO	ENERGIA	TENUTA
LED	5500K Bianca	9.6W	960 LUMENS metro lineare	IP44

A (cm)	H (cm)	COD	PVP
60	80	SM.06080	-
80	80	SM.08080	-

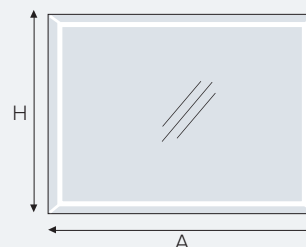

### FRONLED: Illuminazione perimetrale anteriore 4 lati



- Standard
- Profilo perimetrale alluminio spazzolato

LUCE	COLORE °K	CONSUMO	ENERGIA	TENUTA
LED	5500°K Bianca	9.6W	960 LUMENS metro lineare	IP44

Personalizza il tuo LED a 3000°K e 4200°K senza costi aggiuntivi. Standard da 5500°K.

A (cm)	H (cm)	COD	PVP
60	80	SA.06080	-
80	80	SA.08080	-
100	80	SA.10080	-
120	80	SA.12080	-

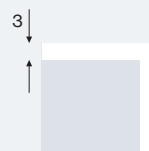
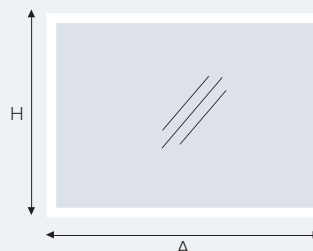

#### & complementi

Sistema antiappannamento,  
Led 5X,  
Sensore On/Off,  
Sensore di colore,  
Sensore Bluetooth,  
Sensore Screen,  
Pagine.....310-312

### DUOLED: Illuminazione frontale superiore e inferiore

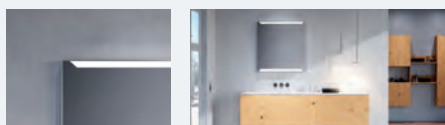
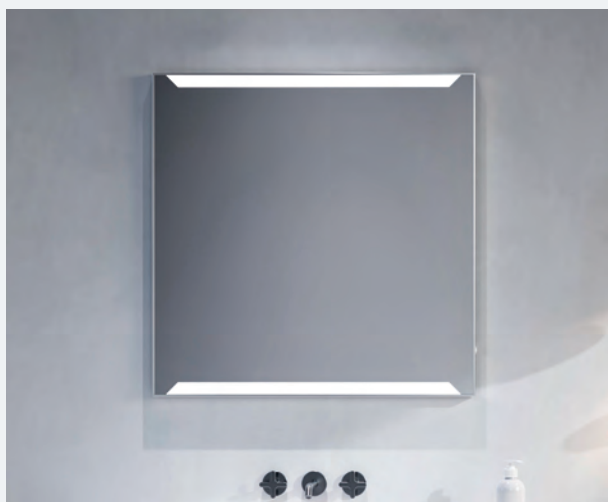

- Standard e personalizzato
- Sensore laterale On / Off + regolatore di intensità

LUCE	COLORE °K	CONSUMO	ENERGIA	TENUTA
LED	5500°K Bianca	9.6W	960 LUMENS metro lineare	IP44

Personalizza il tuo LED a 3000°K e 4200°K senza costi aggiuntivi. Standard de 5500°K.

A (cm)	H (cm)	COD	PVP
60	80	SG.06080	-
80	80	SG.08080	-
100	80	SG.10080	-
120	80	SG.12080	-

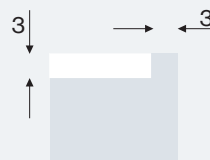
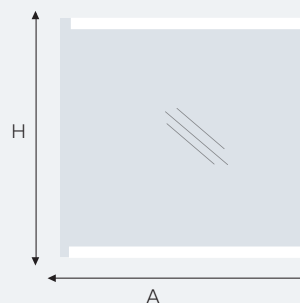

#### & complementi

Sistema antiappannamento,  
Led 5X,  
Pag.....310



### TRILED: Illuminazione frontale superiore e laterale

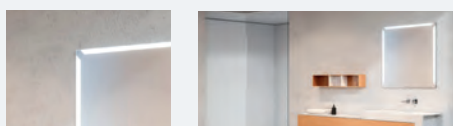

- Standard e personalizzato
- Sistema antinfortunistico sicuro

LUCE	COLORE °K	CONSUMO	ENERGIA	TENUTA
LED	5500K Bianca	9.6W	960 LUMENS metro lineare	IP44

Personalizza il tuo LED a 3000°K e 4200°K senza costi aggiuntivi. Standard de 5500°K.

A (cm)	H (cm)	COD	PVP
60	80	SH.06080	-
80	80	SH.08080	-
100	80	SH.10080	-
120	80	SH.12080	-

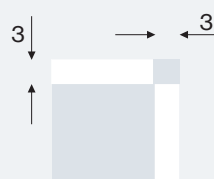
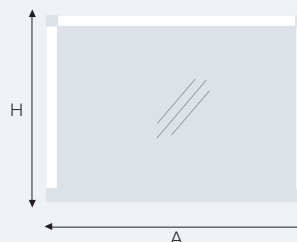

#### & complementi

Sistema antiappannamento,  
Led 5X,  
Sensore On/Off,  
Sensore di colore,  
Sensore Bluetooth,  
Sensore Screen,  
Pagine.....310-312

### EYELED: Illuminazione frontale

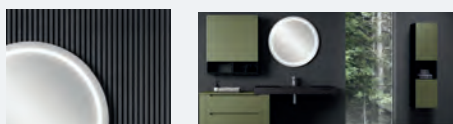

LUCE	COLORE °K	CONSUMO	ENERGIA	TENUTA
LED	5500K Bianca	9.6W	960 LUMENS metro lineare	IP44

Personalizza il tuo LED a 3000°K e 4200°K senza costi aggiuntivi. Standard de 5500°K.

D (cm)	COD	PVP
60	SY.06060	-
80	SY.08080	-

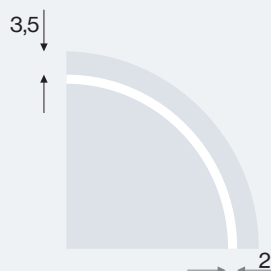
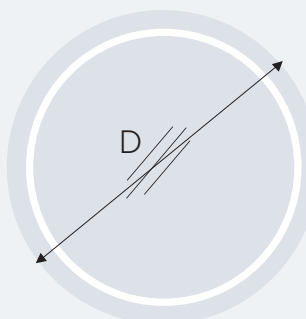

#### & complementi

Sistema antiappannamento,  
Sensore On/Off,  
Sensore antiappannamento  
Pagine.....310-312

**METALROUNDED:** Led in metallo liscio + rotondo

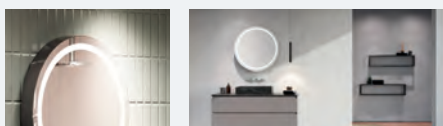

**COLORI:**  
 Nero  
 Cromo

LUCE	COLORE °K	CONSUMO	ENERGIA	TENUTA
LED	5500K Bianca	9.6W	960 LUMENS metro lineare	IP44

Personalizza il tuo LED a 3000°K e 4200°K senza costi aggiuntivi. Standard de 5500°K.

**METALSQUARELED:** Led in metallo liscio + quadrato

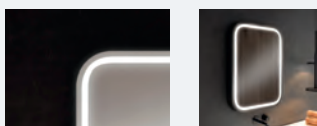

**COLORI:**  
 Nero  
 Cromo

LUCE	COLORE °K	CONSUMO	ENERGIA	TENUTA
LED	5500K Bianca	9.6W	960 LUMENS metro lineare	IP44

Personalizza il tuo LED a 3000°K e 4200°K senza costi aggiuntivi. Standard de 5500°K.

TIPI	D (cm)	COD	PVP
Nero	60	SJ.06060.N	-
	80	SJ.08080.N	-

Cromo	60	SJ.06060.CR	-
	80	SJ.08080.CR	-

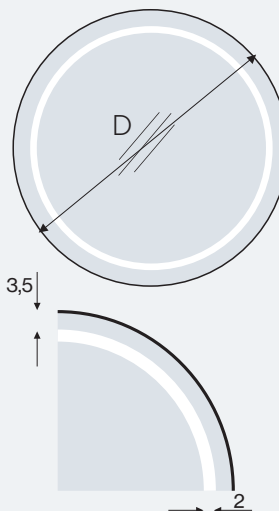

**& complementi**  
 Sistema antiappannamento,  
 Sensore On/Off,  
 Sensore antiappannamento  
 Pagine.....310-312

TIPI	A (cm)	H (cm)	COD	PVP
Nero	60	80	SK.06080.N	-
	80	80	SK.08080.N	-
	100	80	SK.10080.N	-
	120	80	SK.12080.N	-

Cromo	60	80	SK.06080.CR	-
	80	80	SK.08080.CR	-
	100	80	SK.10080.CR	-
	120	80	SK.12080.CR	-

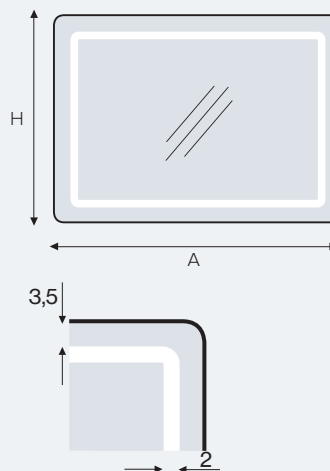

**& complementi**  
 Sistema antiappannamento,  
 Sensore On/Off,  
 Sensore antiappannamento  
 Pagine.....310-312

### METALROUND: Rotondo in metallo liscio

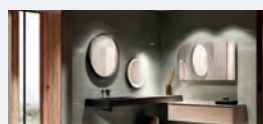

COLORI:  
 Nero  
 Cromo

TIPI	D (cm)	COD	PVP
Nero	60	SL.06060.N	-
	80	SL.08080.N	-
Cromo	60	SL.06060.CR	-
	80	SL.08080.CR	-

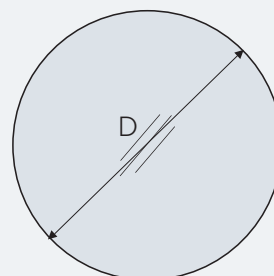

#### & complementi

Sistema antiappannamento  
 Pagine.....310

### METALSQUARE: Quadrato in metallo liscio



COLORI:  
 Nero  
 Cromo

TIPI	A (cm)	H (cm)	COD	PVP
Nero	60	80	SQ.06080.N	-
	80	80	SQ.08080.N	-
	100	80	SQ.10080.N	-
	120	80	SQ.12080.N	-
Cromo	60	80	SQ.06080.CR	-
	80	80	SQ.08080.CR	-
	100	80	SQ.10080.CR	-
	120	80	SQ.12080.CR	-

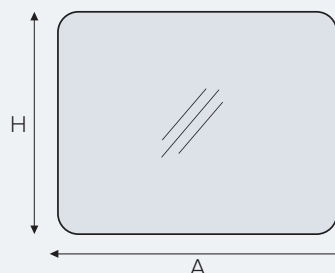

#### & complementi

Sistema antiappannamento,  
 Led 5X  
 Pagine.....310

**CORNER:** Cornice in legno con profilo prismatico

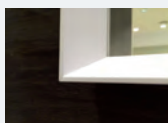

**COLORI**

- Bianco opaco
- Nero opaco

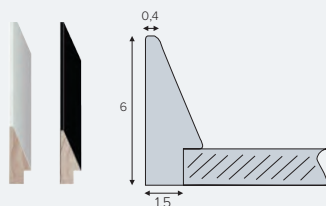

A (cm)	H (cm)	COD	PVP
60 a 80	60 a 90	SU.08090	-
81 a 100	60 a 90	SU.10090	-
101 a 120	60 a 90	SU.12090	-
121 a 140	60 a 90	SU.14090	-
141 a 160	60 a 90	SU.16090	-
161 a 180	60 a 90	SU.18090	-
181 a 200	60 a 90	SU.20090	-
40 a 60	150 a 200	SU.060200	-

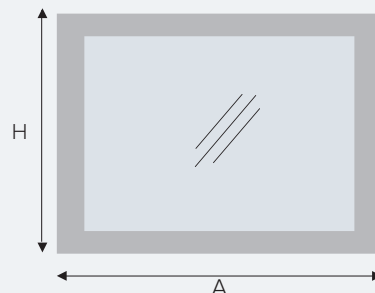

**LUXOR:** Decorativo in legno incorniciato



**COLORI**

- Foglia d'argento
- Foglia d'oro

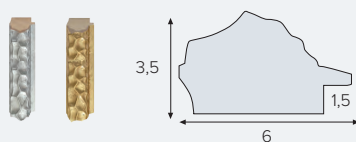

A (cm)	H (cm)	COD	PVP
60 a 80	60 a 90	SX.08090	-
81 a 100	60 a 90	SX.10090	-
101 a 120	60 a 90	SX.12090	-
121 a 140	60 a 90	SX.14090	-
141 a 160	60 a 90	SX.16090	-
161 a 180	60 a 90	SX.18090	-
181 a 200	60 a 90	SX.20090	-
40 a 60	150 a 200	SX.060200	-

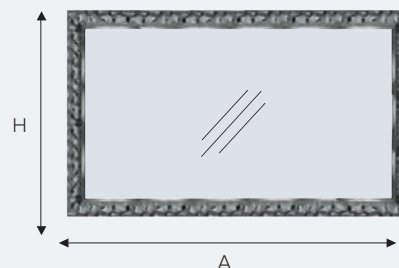

### ARMADIO A SPECCHIO A 1 ANTA

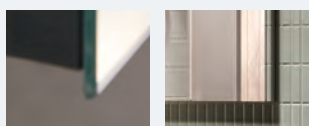

- Standard e personalizzato
- Appendini regolabili
- Modulabile
- Lati a specchio
- 2 ripiani interni in vetro
- Interni antracite
- Compatibile con inserti a specchio
- Porta con maniglia inferiore nascosta e chiusura rallentata

A (cm)	H (cm)	Apertura	COD	PVP
30	72		SW.3072I	-
30	72		SW.3072D	-
40	72		SW.4072I	-
40	72		SW.4072D	-
60	72		SW.6072I	-
60	72		SW.6072D	-

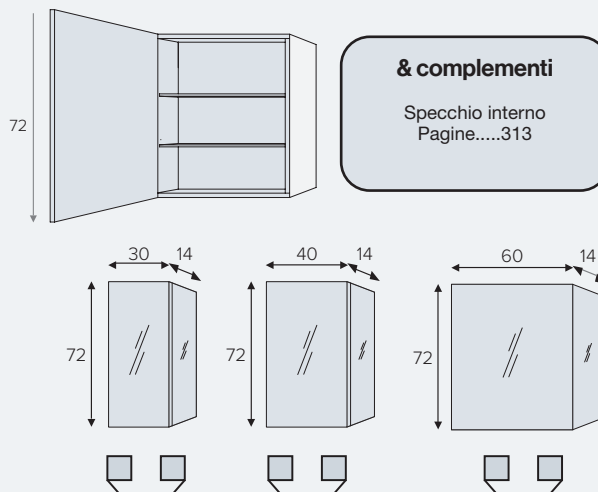

### ARMADIO A SPECCHIO A 2 PORTE

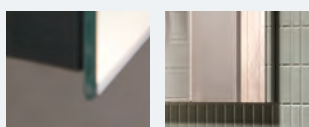

- Standard e personalizzato
- Appendini regolabili
- Modulabile
- Fianchi a specchio
- 2 ripiani interni in vetro
- Interni antracite
- Compatibile con inserti a specchio
- Porta con maniglia inferiore nascosta e chiusura rallentata

A (cm)	H (cm)	Apertura	COD	PVP
80 (60+20)	72		SZ.8072I	-
80 (20+60)	72		SZ.8072D	-
90 (60+30)	72		SZ.9072I	-
90 (30+60)	72		SZ.9072D	-
100 (60+40)	72		SZ.10072I	-
100 (40+60)	72		SZ.10072D	-

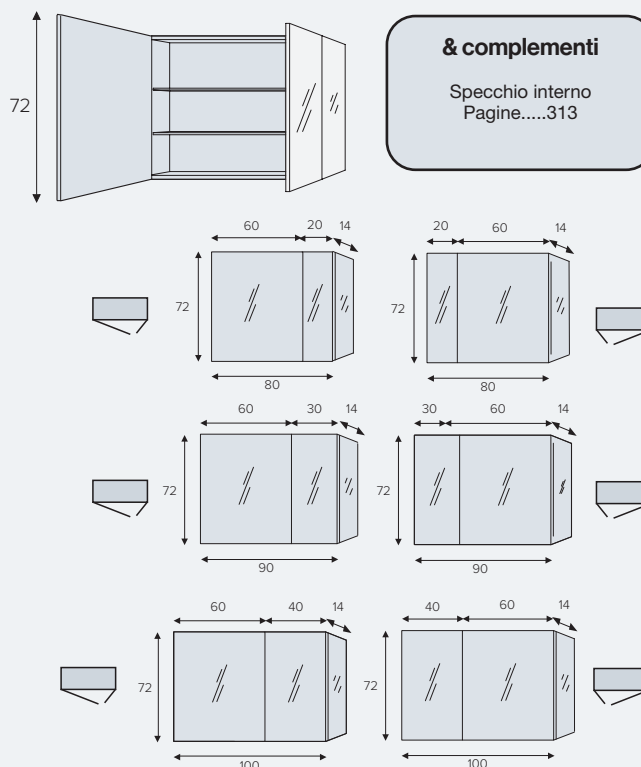

### SISTEMA ANTIAPPANNAMENTO

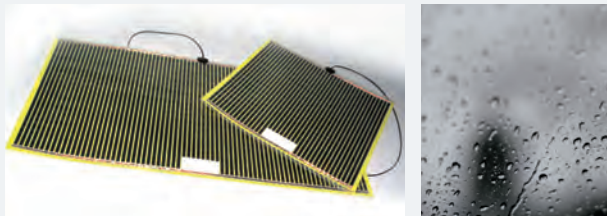

CONSUMO

9.6W

TENUTA

IP44

### SENSORE ANTIAPPANNAMENTO



antiappannamento



### LED 5X



LED 5X



COD

PVP

X004UNO (Indicato per mobili con un lavabo) -

X004DOS (Indicato per mobili con 2 lavabi) -

#### Sistema antiappannamento

Evita la condensa d'acqua sullo specchio che distorce l'immagine. Può essere collegato direttamente alla rete elettrica oppure accenderlo e spegnerlo con il sensore touch.

In funzione dell'equipaggiamento e della struttura del tuo specchio ti aiuteremo a scegliere il sistema anti appannante più consono alla misura dello specchio.

COD

PVP

X008 -

Richiede sistema antiappannamento

#### Sensore antiappannamento

Permette di accendere e spegnere il sistema antiappannamento.

COD

PVP

X015 -

#### LED 5X

Specchio ingranditore 5X integrato nello specchio stesso. Perimetro illuminato da luce Led.

**SENSORE ON / OFF**



On / Off  
+  
Regolatore di  
intensità

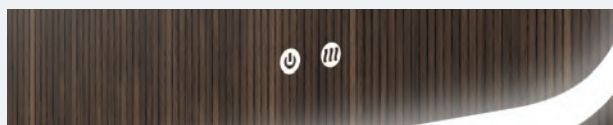

**SENSORE DI COLORE**

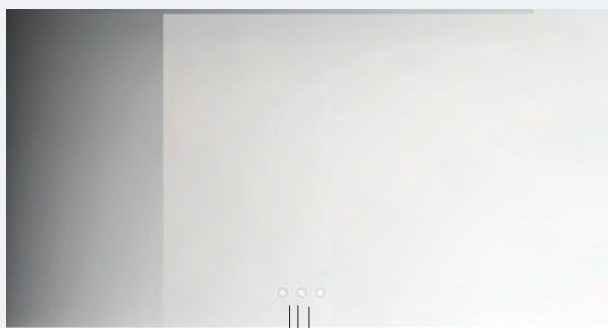

On / Off — 3000°K  
5000°K  
Regolatore  
Intensità



**GENERE**

**COD**

**PVP**

Sensore ON/OFF Senza sensore antiappannamento	X007	-
Sensore ON/OFF Sensore antiappannamento (richiede X004DOS o X008)	X009	-

**SENSORE ON/OFF**

Accende o spegne la luce Led e permette anche di regolarne l'intensità a scelta dell'utente.

**& compatibile** con sistema anti-appannamento e LED 5X

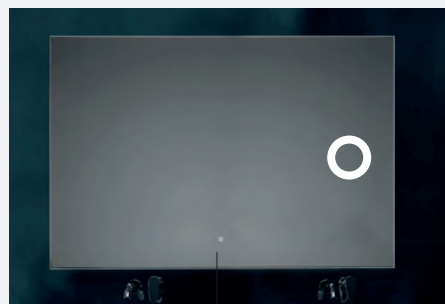

Anti nebbia  
(Opzionale)

LED 5X  
(Opzionale)

**COD**

**PVP**

X011

-

**SENSORE DI COLORE**

Consente di modificare la temperatura del colore della luce calda, neutra o fredda e / o l'intensità della luce.

**& compatibile** con Sistema antiappannamento e LED 5X

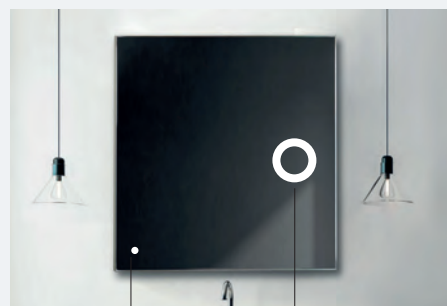

Anti nebbia  
(Opzionale)

LED 5X  
(Opzionale)

**SENSORE BLUETOOTH**



On/Off Bluetooth  
On/Off + Regolatore di intensità

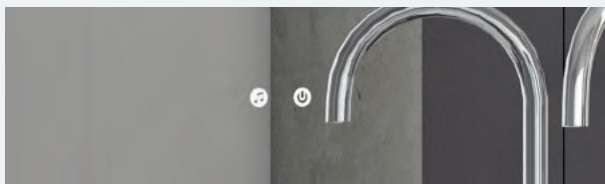

**COD**

**PVP**

X013

-

**SISTEMA BLUETOOTH**

Consente di collegare lo specchio al telefono cellulare tramite il dispositivo Bluetooth. Include anche un sistema di altoparlanti integrato nello specchio. Include il sistema On / Off per l'accensione e la regolazione dell'intensità.

**& compatibile** con sistema anti-appannamento e LED 5X



Anti nebbia (Opzionale)

LED 5X (Opzionale)

**SENSORE SCREEN**



On / Off Screen  
On / Off + Regolatore di intensità  
Screen

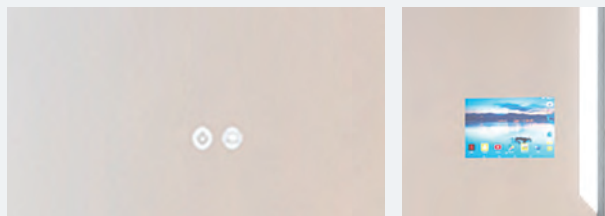

Dimensioni dello schermo:  
17 larghezza x 10 altezza (cm)

**COD**

**PVP**

X012

-

Disponibile da 80 cm di larghezza specchi.

**SENSORE SCREEN**

Consente di collegare lo specchio al telefono cellulare tramite il dispositivo Bluetooth e riproduce lo schermo del cellulare. Schermo da 10 pollici. Include il sistema con accensione On / Off e regolazione dell'intensità.

**& compatibile** con sistema anti-appannamento

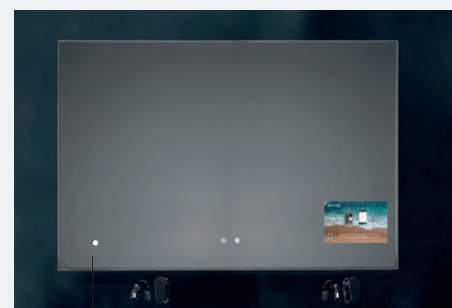

Anti nebbia (Opzionale)



### SPECCHIO DI INGRANDIMENTO MAGNETICO 3X



D (cm)	COD	PVP
--------	-----	-----

14	98912 MAG	-
----	-----------	---

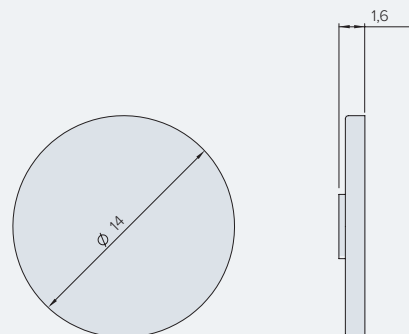

### SPECCHIO INTERNO ARMADIO-SPECCHIO



Adatto per armadietti a specchio e pensili.

PORTA	A (cm)	H (cm)	COD	PVP
-------	--------	--------	-----	-----

30/40/60	22	68	98922INT	-
----------	----	----	----------	---

20*	12	68	98923INT	-
-----	----	----	----------	---

\*Per la porta da 20 cm, lo specchio interno è largo 12 cm.

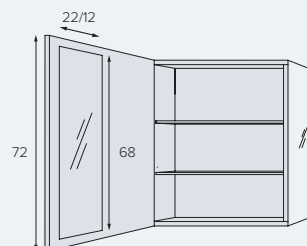



# 05

## Illuminazione

La tecnologia LED applicata sulle applique a specchio e nell'illuminazione decorativa consente di creare scenari personalizzati.



**APPLIQUE PER SPECCHI**

Applique da installare sopra gli specchi e sugli specchi dell'armadio. Diversi modelli, potenze e temperature di colore.



**Ledin**  
pag. 318



**Ledcristal**  
pag. 318

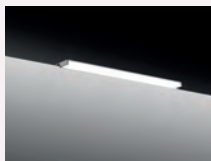

**Ledbar**  
pag. 319

**ILLUMINAZIONE DECORATIVA**

Illuminazione decorativa a sospensione e luce personalizzabile per creare atmosfere.



**Ledarc**  
pag. 320

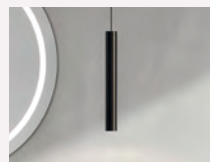

**Ledpoint**  
pag. 320

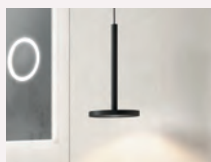

**Ledcirc**  
pag. 321

## Cosa devi sapere per avere una buona illuminazione nel tuo bagno?

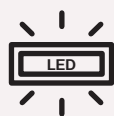

### TIPO DI LUCE

Il tipo di luce a led è a bassissimo consumo, accensione rapida e lunga durata; inoltre non emette calore. Per il suo funzionamento necessita di un driver che in molti casi è integrato nel proiettore stesso.



### CONSUMO

Si misura in watt (w). Meno watt, minori consumi. La "w" non è il riferimento per misurare l'intensità della luce e la sua capacità luminosa; ma per fare questo, esamineremo i lumen / lux.

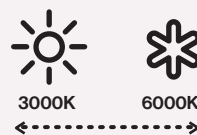

### TEMPERATURA DI COLORE

È la tonalità della luce, espressa in gradi Kelvin (°K). Una tonalità calda più giallastra è di circa 3000K e una tonalità fredda più bianca è di circa 5000-6000K. La tendenza è quella di andare verso toni neutri che sono a 4000°K.



### LUMENS

La variabile per identificare se un apparecchio fornisce più luce di un altro sono i lumen. Più lumen, maggiore intensità luminosa. Secondo i codici generali di illuminazione in un bagno ci sono due esigenze di luce.

- L'area del mobile lavabo. Per il trucco o la rasatura, si consiglia un minimo di 300 lumen. Circa 700 lumen sono ideali per aiutare l'illuminazione generale del bagno. Se anche l'illuminazione è neutra (4000°K), aiuta a prevenire l'alterazione dei colori della pelle.
- L'area di transito. I faretti a soffitto devono fornirci una luce generale morbida. Si consigliano circa 200-300 lumen per m<sup>2</sup>.



### TENUTA

È il livello di esposizione agli elementi o ad agenti esterni come l'acqua. È misurato da IP e vanno da IP20, IP44 e IP65, da meno a più a tenuta stagna.

### LEDIN



Compatibile con specchi lisci

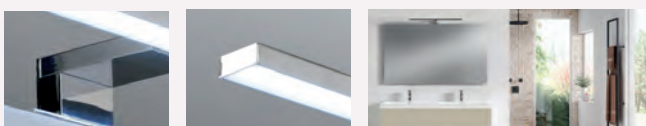

LUCE

LED

COLORE °K

4000°K  
Neutra

CONSUMO

4.71 W  
8 W

TENUTA

IP20

A (cm)	Colore	Temp (°K)	Consumo(W)	Lumens (lm)	COD	PVP
30	Cromo lucido	4000	4.71	325	LAI.30.B	-
45	Cromo lucido	4000	8	465	LAI.45.B	-

30	Nero	4000	4.71	325	LAI.30.N	-
45	Nero	4000	8	465	LAI.45.N	-

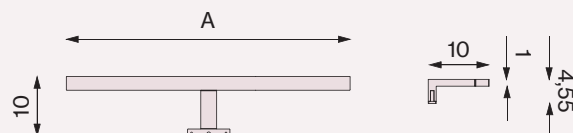

### LEDCRIL

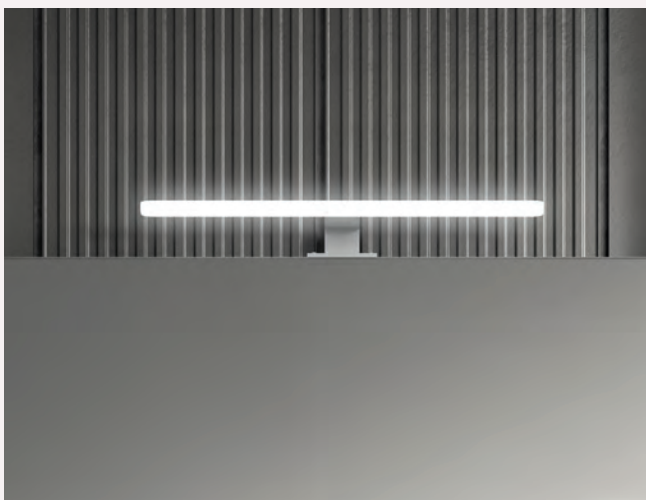

Compatibile con specchi lisci



LUCE

LED

COLORE °K

4000°K  
Neutra

CONSUMO

8 W  
12 W

TENUTA

IP20

A (cm)	Colore	Temp (°K)	Consumo(W)	Lumens (lm)	COD	PVP
45	Cromo lucido e metacrilato	4000	8	890	LAC.45.B	-
60	Cromo lucido e metacrilato	4000	12	1295	LAC.60.B	-

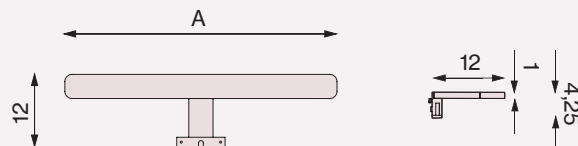

### LEDBAR

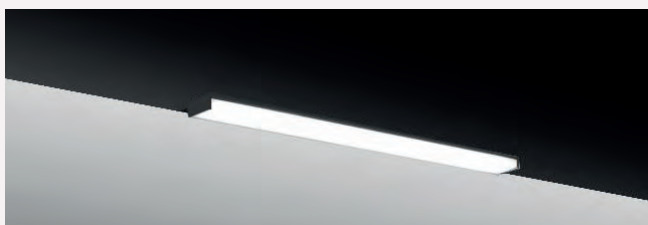

Compatibile con il modello SLM

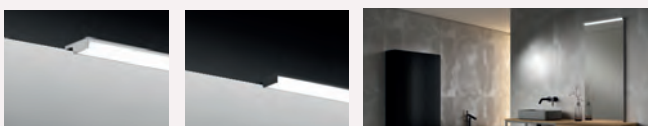

LUCE

LED

COLORE °K

4000°K  
Neutra

CONSUMO

4.9W  
8W

TENUTA

IP20

A (cm)	Colore	Temp (°K)	Consumo(W)	Lumens (lm)	COD	PVP
60	Cromo	4000	15	1365	LAB.60.B	-
80	Cromo	4000	20	1870	LAB.80.B	-
100	Cromo	4000	25	2355	LAB.10.B	-
120	Cromo	4000	30	2780	LAB.12.B	-
140	Cromo	4000	35	3320	LAB.14.B	-

60	Nero	4000	15	1365	LAB.60.N	-
80	Nero	4000	20	1870	LAB.80.N	-
100	Nero	4000	25	2355	LAB.10.N	-
120	Nero	4000	30	2780	LAB.12.N	-
140	Nero	4000	35	3320	LAB.14.N	-

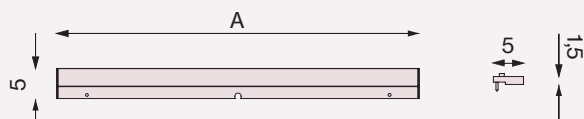

LEDARC



Ganci di sospensione regolabili



LUCE	COLORE °K	CONSUMO	TENUTA
LED	3000°K Caldo	26W	IP20

A (cm)	Colore	Temp (°K)	Consumo(W)	Lumens (lm)	COD	PVP
120	Nero	3000	26	3500	LCA.12.N	-

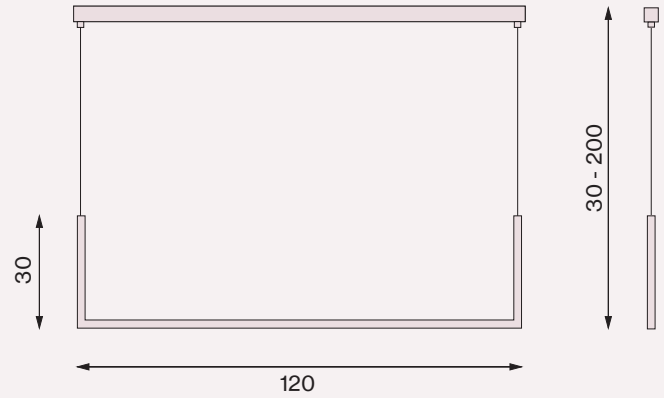

LEDPOINT



Ganci di sospensione regolabili

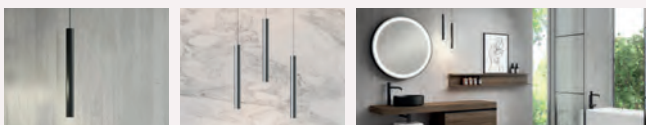

LUCE	COLORE °K	CONSUMO	TENUTA
LED	3000°K Caldo 4000°K NeutrO	6W	IP20

Colore	Temp (°K)	Consumo (W)	Lumens (lm)	COD	PVP
Bianco	3000	6	760	LCP.30.W	-
Bianco	4000	6	760	LCP.40.W	-
Nero	3000	6	760	LCP.30.N	-
Nero	4000	6	760	LCP.40.N	-
Rame	3000	6	760	LCP.30.CU	-
Rame	4000	6	760	LCP.40.CU	-
Oro	3000	6	760	LCP.30.AU	-
Oro	4000	6	760	LCP.40.AU	-
Acciaio	3000	6	760	LCP.30.S	-
Acciaio	4000	6	760	LCP.40.S	-

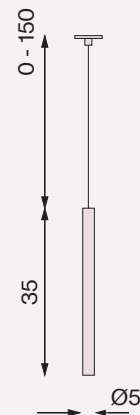



LEDCIRC



Ganci di sospensione regolabili

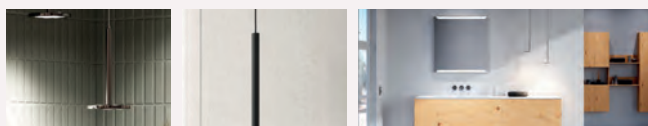

LUCE

COLORE °K

CONSUMO

TENUTA

LED

3000°K  
Caldo

6W

IP20

Colore	Temp (°K)	Consumo (W)	Lumens (lm)	COD	PVP
Bianco	3000	6	660	LCC.30.W	-
Nero	3000	6	660	LCC.30.N	-
Rame	3000	6	660	LCC.30.CU	-
Oro	3000	6	660	LCC.30.AU	-
Acciaio	3000	6	660	LCC.30.S	-

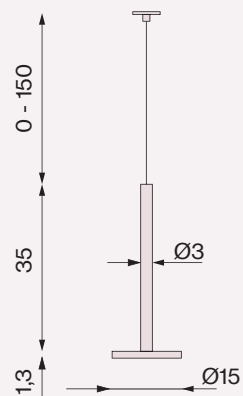



# 06

## Accessori

L'arredamento del bagno è un insieme.  
Colonne, armadi, mensole, vasche da bagno  
o accessori si aggiungono a una proposta  
completa.

## COLONNE



**Pensile sospeso  
H160 porta in legno**

pag. 328



**Pensile sospeso  
H160 vetrina**

pag. 328



**Pensile sospesa  
H160 specchio**

pag. 329



**Pensile sospesa  
H160 decorativo**

pag. 329

## ARMADI

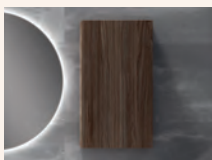

**Porta cabinet  
H72 legno**

pag. 330

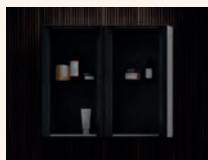

**Vetrina cabinet H72**

pag. 330



**Armadio specchio H72**

pag. 331



**Armadio H90 decorativo**

pag. 331

## RIPIANI



**Scaffalatura Complet**

pag. 332

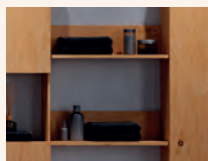

**Scaffalatura Twin**

pag. 332



**Scaffalatura Box**

pag. 333

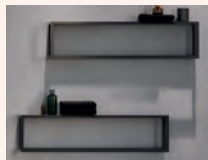

**Mensola in metallo  
con doppio ripiano**

pag. 333

**PORTASCIUGAMANI**

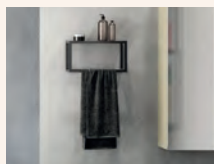

**Scaffalatura in metallo con portasciugamani**

pag. 334

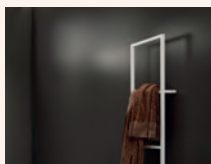

**Portasciugamani da parete**

pag. 334



**Portasciugamani indipendente**

pag. 335



**Sgabello**

pag. 335

**AUSILIARI ATELIER**

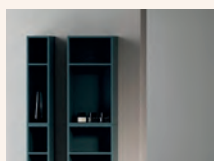

**Armadietto a pensile**

pag. 336

By CIRCULO\*  
CUADRADO

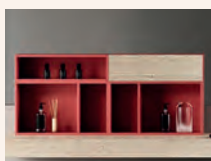

**Specchio toilette**

pag. 337

By CIRCULO\*  
CUADRADO

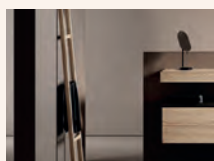

**Porta asciugamani Lean**

pag. 337



### PUSH PORTE SENZA MANIGLIA

Le ante delle colonne e degli armadi hanno il sistema di espulsione push che può essere utilizzato anche solo come fermo.

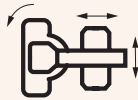

### CERNIERE BLUM 3D

Le cerniere sono regolabili in altezza, profondità e inclinazione per una vestibilità perfetta.

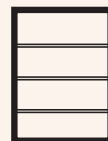

### RIPIANI INTERNI CRISTALLO

I ripiani interni in vetro hanno uno spessore di 6 mm. Nel caso di vetrine e pensili, i ripiani sono grigio fumé.



### SISTEMA DI SICUREZZA PENSILE SUPPORTA 150 KG

Le colonne e gli armadi hanno un sistema di sospensione di sicurezza con una capacità di carico di 150 Kg.



### FULLCOLOR ANTRACITE

Idea di design d'interni per cui tutti i materiali degli interni dei mobili sono progettati in colore antracite. Il mobile con finitura laccata è internamente laccato antracite.



### SU MISURA

Questa collezione consente la produzione personalizzata. In caso di misure intermedie in altezza e larghezza prendere il prezzo della misura immediatamente più alta.



### DECOBUILD SYSTEM

Mobili realizzati con tavole da 19 mm incollate insieme ottenendo un'estetica pulita senza inserti visibili, offre una migliore resistenza e durezza.



### WOOD PROTECT SYSTEM

Il legno massello o di tavola marina sono protetti dagli agenti esterni con oli naturali che rispettano la consistenza e la natura del legno.



### DURALACK SYSTEM

I colori laccati contengono additivi indurenti che permettono alla finitura finale di essere altamente resistente allo sfregamento e all'abrasione.

## Scegli il colore dei tuoi complementi d'arredo

### Laccato



### Pannello Multistrato Marino / Impiallacciato Rovere e Noce

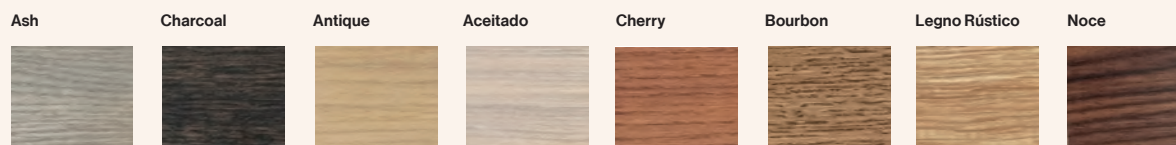

### Legno Nature

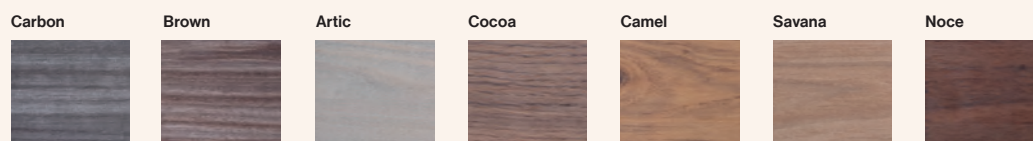

### Legno Massello / Roble

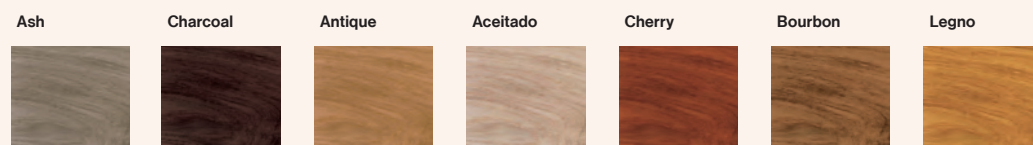

### COLONNA SOSPESA H160 LEGNO



- Interno: 4 ripiani vetro / 5 fori
- Sistema di apertura Push
- Fondo antracite

A (cm)	H (cm)	Apertura	COD	LEGNO NATURE	LACCA	PANNELLO MULTISTRATO MARINO
				PVP	PVP	PVP
30	160		XCM.030I	-	-	-
30	160		XCM.030D	-	-	-
40	160		XCM.040I	-	-	-
40	160		XCM.040D	-	-	-
60	160		XCM.060X	-	-	-

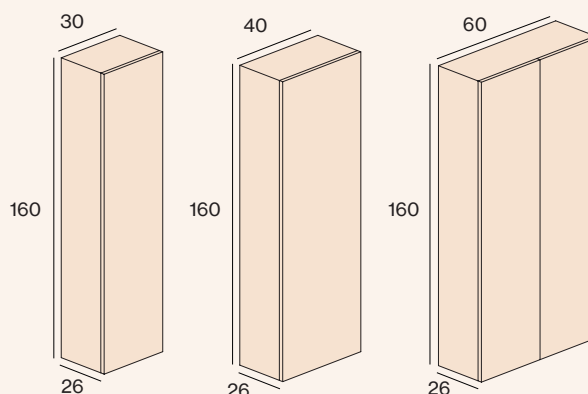

### VETRINA A COLONNA SOSPESA H160

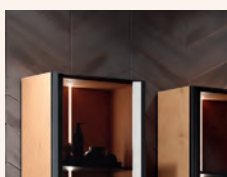

- Interno: 4 ripiani vetro / 5 fori
- Sistema di apertura push
- Fondo antracite
- Porta intelaiata nera
- Opaco con vetro nero fumé

A (cm)	H (cm)	Apertura	COD	LEGNO NATURE	LACCA	PANNELLO MULTISTRATO MARINO
				PVP	PVP	PVP
30	160		XCV.030I	-	-	-
30	160		XCV.030D	-	-	-
40	160		XCV.040I	-	-	-
40	160		XCV.040D	-	-	-
60	160		XCV.060X	-	-	-

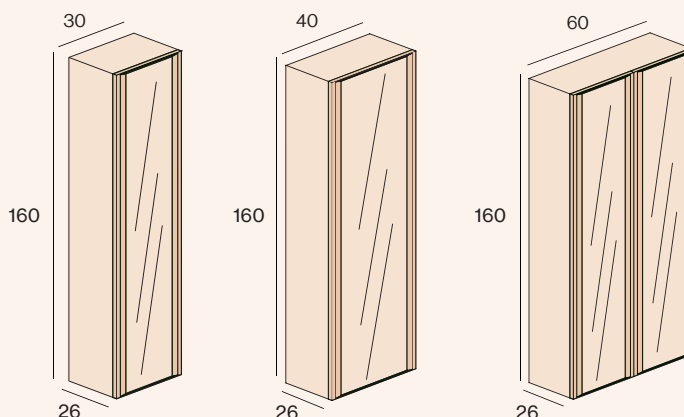

È possibile mettere nella tua colonna l'illuminazione interna. Vedi pagina 250



### COLONNA SOSPESA H160 SPECCHIO

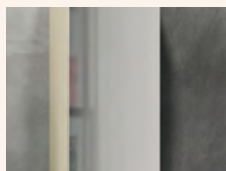

- Interno: 4 ripiani vetro / 5 fori
- Sistema di apertura Push
- Fondo antracite

A (cm)	H (cm)	Apertura	COD	LEGNO	LACCA	PANNELLO
				NATURE	PVP	MULTISTRATO MARINO
30	160		XCE.030I	-	-	-
30	160		XCE.030D	-	-	-
40	160		XCE.040I	-	-	-
40	160		XCE.040D	-	-	-
60	160		XCE.060X	-	-	-

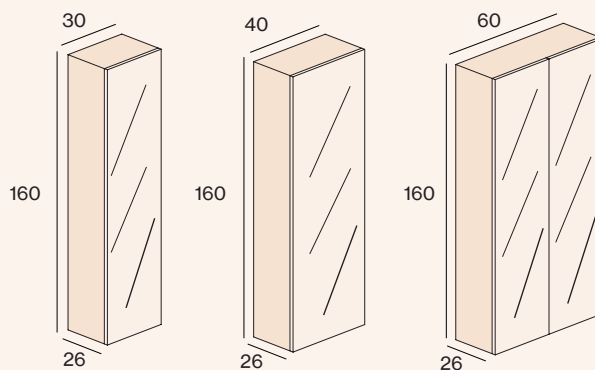

### COLONNA SOSPESA H160 DECORATIVA

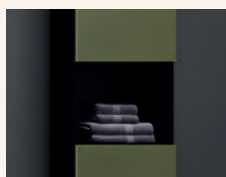

- Interno: porta superiore
- 2 ripiani in vetro / 3 incavi
- Sistema di apertura Push
- Fondo antracite

A (cm)	H (cm)	Apertura	COD	LEGNO	LACCA	PANNELLO
				NATURE	PVP	MULTISTRATO MARINO
30	160		XCD.030I	-	-	-
30	160		XCD.030D	-	-	-
40	160		XCD.040I	-	-	-
40	160		XCD.040D	-	-	-
60	160		XCD.060X	-	-	-

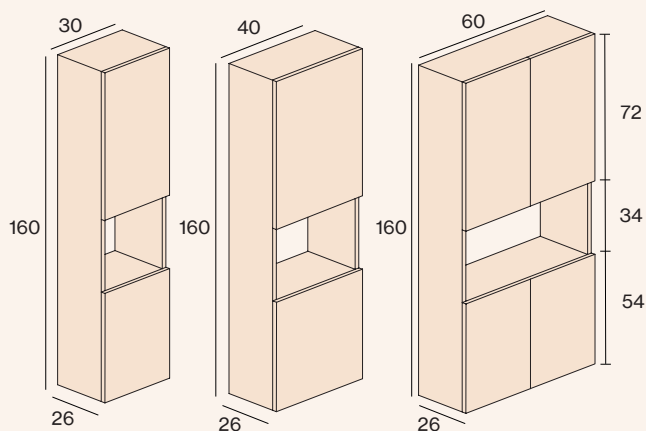

#### GAMBE H7

· Set di gambe cromate lucide, altezza 7 cm. (4 unità)

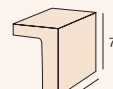

Cromo Lucido

COD	UDS	PVP
CM7	4	-

#### GAMBE H3

· Set di gambe cromate lucide, altezza 3,6 cm. (4 unità)

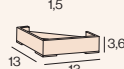

Cromo Lucido

COD	UDS	PVP
CM6	4	-

### ARMADIO IN LEGNO H72

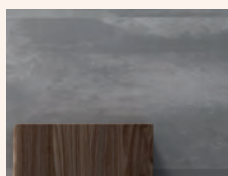

- Interno: 2 ripiani vetro / 3 fori
- Sistema di apertura push
- Fondo antracite

A (cm)	H (cm)	Apertura	COD	LEGNO NATURE	LACCA	PANNELLO MULTISTRATO MARINO
				PVP	PVP	PVP
30	72	☐	XAM.030I	-	-	-
30	72	☐	XAM.030D	-	-	-
40	72	☐	XAM.040I	-	-	-
40	72	☐	XAM.040D	-	-	-
60	72	☐	XAM.060X	-	-	-

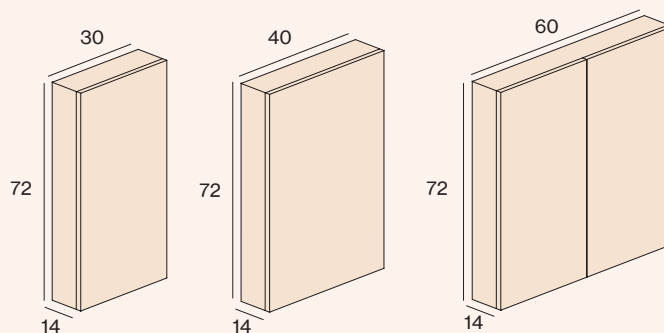

### VETRINA ARMADIO H72

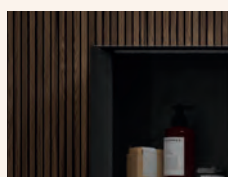
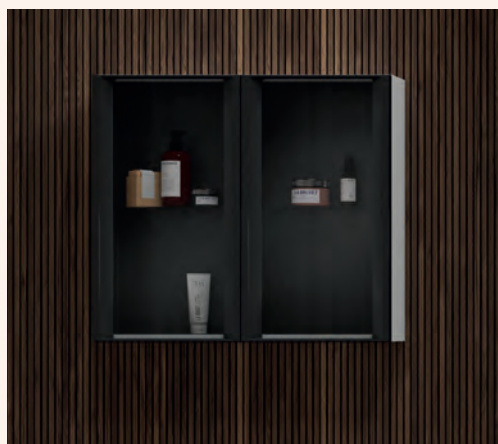

- Interno: 2 ripiani vetro / 3 fori
- Sistema di apertura push
- Fondo antracite
- Porta intelaiata nera opaco con vetro nero fumé

A (cm)	H (cm)	Apertura	COD	LEGNO NATURE	LACCA	PANNELLO MULTISTRATO MARINO
				PVP	PVP	PVP
30	72	☐	XAV.030I	-	-	-
30	72	☐	XAV.030D	-	-	-
40	72	☐	XAV.040I	-	-	-
40	72	☐	XAV.040D	-	-	-
60	72	☐	XAV.060X	-	-	-

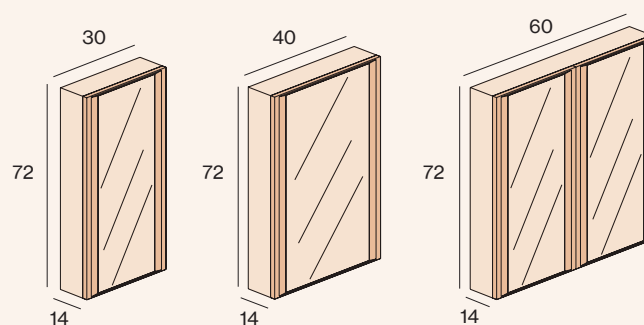

### H72 SPECCHIO ARMADIO

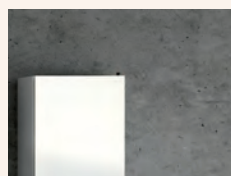

- Interno: 2 ripiani vetro / 3 fori
- Sistema di apertura push
- Fondo antracite

A (cm)	H (cm)	Apertura	COD	LEGNO NATURE	LACCA	PANNELLO MULTISTRATO MARINO
				PVP	PVP	PVP
30	72		XAE.030I	-	-	-
30	72		XAE.030D	-	-	-
40	72		XAE.040I	-	-	-
40	72		XAE.040D	-	-	-
60	72		XAE.060X	-	-	-

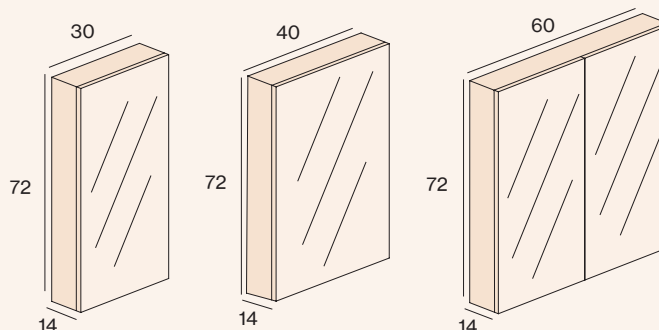

### MOBILE DECORATIVO H90



- Interno: 2 ripiani vetro / 3 fori
- Sistema di apertura push
- Fondo antracite
- Porta intelaiata nera opaco con vetro nero fumé

A (cm)	H (cm)	Apertura	COD	LEGNO NATURE	LACCA	PANNELLO MULTISTRATO MARINO
				PVP	PVP	PVP
30	90		XAD.030I	-	-	-
30	90		XAD.030D	-	-	-
40	90		XAD.040I	-	-	-
40	90		XAD.040D	-	-	-
60	90		XAD.060X	-	-	-

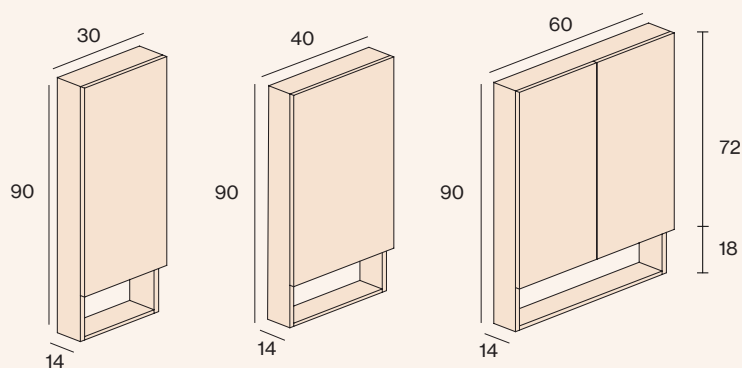

### RIPIANO COMPLET

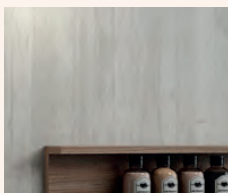

A (cm)	COD	LEGNO NATURE	LACCA	PANNELLO MULTISTRATO MARINO	LEGNO MASSELLO
		PVP	PVP	PVP	PVP
30	XEC.030	-	-	-	-
40	XEC.040	-	-	-	-
60	XEC.060	-	-	-	-
70	XEC.070	-	-	-	-
80	XEC.080	-	-	-	-
90	XEC.090	-	-	-	-
100	XEC.100	-	-	-	-
120	XEC.120	-	-	-	-
140	XEC.140	-	-	-	-

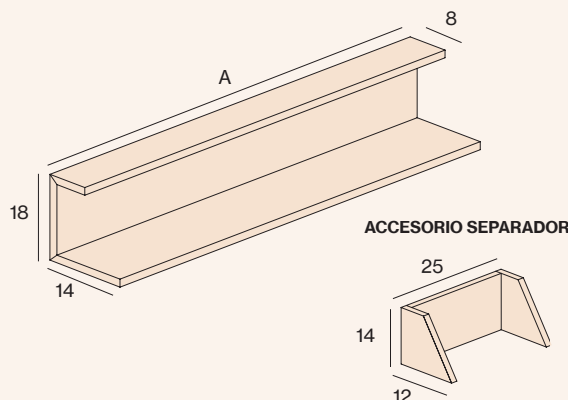

COD	PVP
XSD.2501	-

**Laccato**

### RIPIANO TWIN

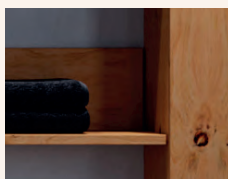

A (cm)	COD	LEGNO NATURE	LACCA	PANNELLO MULTISTRATO MARINO	LEGNO MASSELLO
		PVP	PVP	PVP	PVP
30	XEL.030	-	-	-	-
40	XEL.040	-	-	-	-
60	XEL.060	-	-	-	-
70	XEL.070	-	-	-	-
80	XEL.080	-	-	-	-
90	XEL.090	-	-	-	-
100	XEL.100	-	-	-	-
120	XEL.120	-	-	-	-
140	XEL.140	-	-	-	-

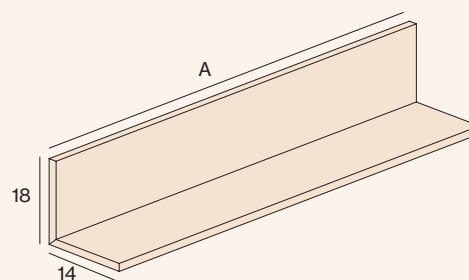

### RIPIANO BOX



A (cm)	COD	LEGNO NATURE	LACCA	PANNELLO MULTISTRATO MARINO	LEGNO MASSELLO
		PVP	PVP	PVP	PVP
30	XEB.030	-	-	-	-
40	XEB.040	-	-	-	-
60	XEB.060	-	-	-	-
70	XEB.070	-	-	-	-
80	XEB.080	-	-	-	-
90	XEB.090	-	-	-	-
100	XEB.100	-	-	-	-
120	XEB.120	-	-	-	-
140	XEB.140	-	-	-	-

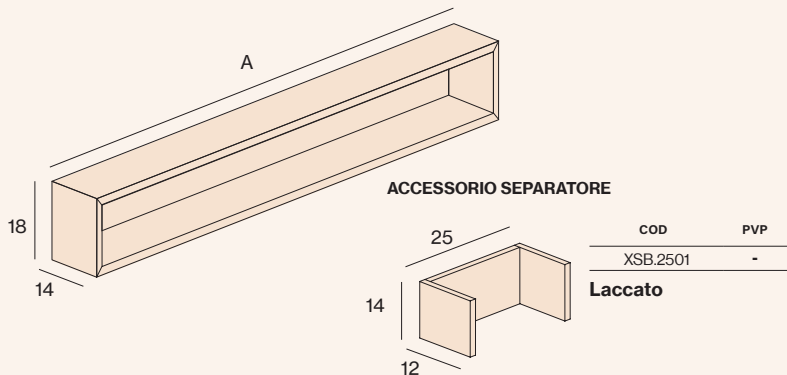

### MENSOLA METALLICA CON DOPPIO RIPIANO



A (cm)	COD	LEGNO NATURE	LACCA	PANNELLO MULTISTRATO MARINO	LEGNO MASSELLO	CRISTAL FUMÉ
		PVP	PVP	PVP	PVP	PVP
<b>STRUTTURA METALLICA NERA</b>						
30	XEM.030.N	-	-	-	-	-
40	XEM.040.N	-	-	-	-	-
60	XEM.060.N	-	-	-	-	-
70	XEM.070.N	-	-	-	-	-
80	XEM.080.N	-	-	-	-	-
90	XEM.090.N	-	-	-	-	-
100	XEM.100.N	-	-	-	-	-
120	XEM.120.N	-	-	-	-	-
140	XEM.140.N	-	-	-	-	-

#### COLORE STRUTTURA METALLICA (TABELLA LACCATA)

30	XEM.030.C	-	-	-	-	-
40	XEM.040.C	-	-	-	-	-
60	XEM.060.C	-	-	-	-	-
70	XEM.070.C	-	-	-	-	-
80	XEM.080.C	-	-	-	-	-
90	XEM.090.C	-	-	-	-	-
100	XEM.100.C	-	-	-	-	-
120	XEM.120.C	-	-	-	-	-
140	XEM.140.C	-	-	-	-	-

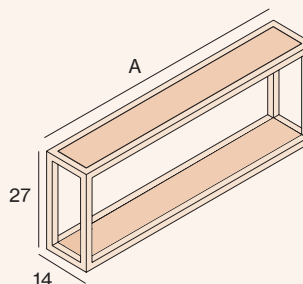

### MENSOLA METALLICA CON PORTASCIUGAMANO

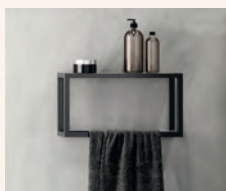

A (cm)	COD	LEGNO NATURE	LACCA	PANNELLO MULTISTRATO MARINO	LEGNO MASSELLO	CRISTAL FUMÉ
		PVP	PVP	PVP	PVP	PVP
<b>STRUTTURA METALLICA NERA</b>						
30	XET.030.N	-	-	-	-	-
40	XET.040.N	-	-	-	-	-
60	XET.060.N	-	-	-	-	-
70	XET.070.N	-	-	-	-	-
80	XET.080.N	-	-	-	-	-
90	XET.090.N	-	-	-	-	-
100	XET.100.N	-	-	-	-	-
120	XET.120.N	-	-	-	-	-
140	XET.140.N	-	-	-	-	-

### COLORE STRUTTURA METALLICA (TABELLA LACCATA)

30	XET.030.C	-	-	-	-	-
40	XET.040.C	-	-	-	-	-
60	XET.060.C	-	-	-	-	-
70	XET.070.C	-	-	-	-	-
80	XET.080.C	-	-	-	-	-
90	XET.090.C	-	-	-	-	-
100	XET.100.C	-	-	-	-	-
120	XET.120.C	-	-	-	-	-
140	XET.140.C	-	-	-	-	-

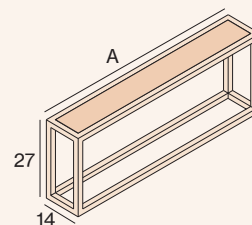

### PORTASALVIETTE DA PARETE

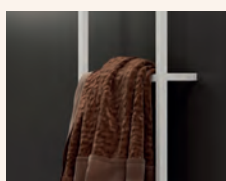

COD	PVP
<b>STRUTTURA METALLICA NERA</b>	
XTP:160.N	-
<b>COLORE STRUTTURA METALLICA (TABELLA LACCATA)</b>	
XTP:160.C	-

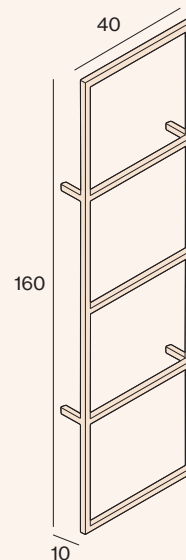

### PORTASCIUGAMANI INDIPENDENTE

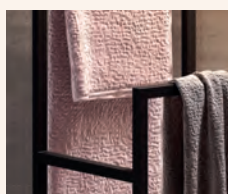

COD	PVP
-----	-----

#### STRUTTURA METALLICA NERA

XTI.090.N	-
-----------	---

#### COLORE STRUTTURA METALLICA (TABELLA LACCATA)

XTI.090.C	-
-----------	---

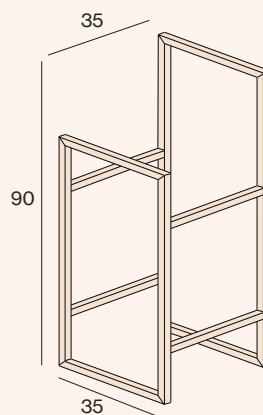

### SGABELLO



A (cm)	COD	LEGNO NATURE	LACCA	PANNELLO MULTISTRATO MARINO	LEGNO MASSELLO
		PVP	PVP	PVP	PVP

#### STRUTTURA METALLICA NERA

35	XTU.035.N	-	-	-	-
60	XTU.060.N	-	-	-	-

#### COLORE STRUTTURA METALLICA (TABELLA LACCATA)

35	XTU.035.C	-	-	-	-
60	XTU.060.C	-	-	-	-

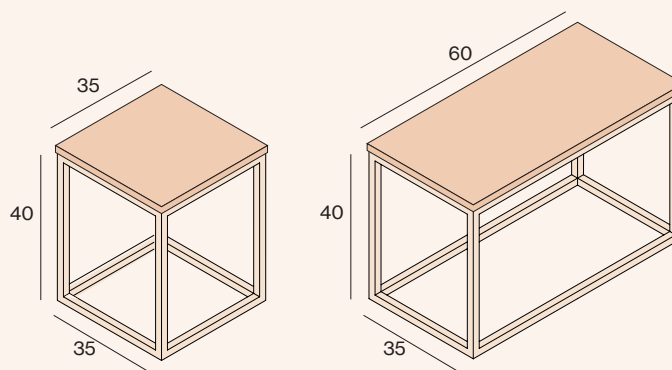

MODULO A COLONNA

By **CIRCULO CUADRADO**



A (cm)	H (cm)	COD	LACCA
			PVP
30	60	XMD.3060	-
15	60	XMD.1560	-
30	90	XMD.3090	-
15	90	XMD.1590	-
30	180	XMD.30180	-
15	180	XMD.15180	-

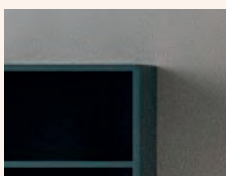
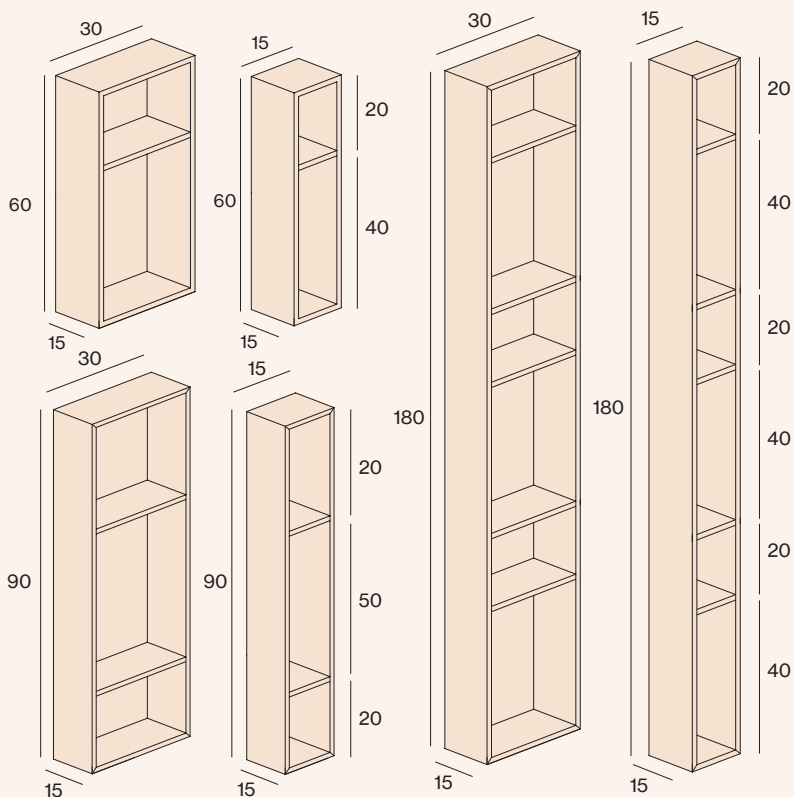

- Spessore 13 mm
- Sistema di sospensione nascosto
- Possibilità di installazione in 2 posizioni

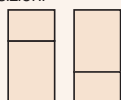



### SPECCHIO TOILETTE

By **CIRCULO<sup>®</sup>**  
**CUADRADO**



- Spessore 13 mm
- Sistema di sospensione nascosto
- Specchio opzionale

A (cm)	SENZA SPECCHIO		CON SPECCHIO	
	COD	PVP	COD	PVP
60	XMB.60	-	XMS.60	-
90	XMB.90	-	XMS.90	-

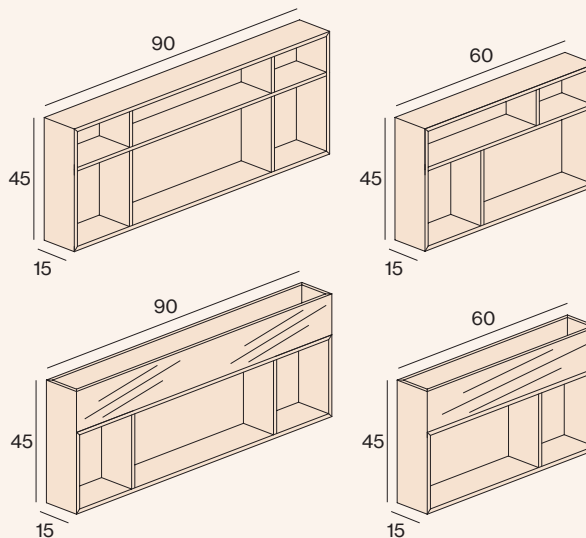

### PORTA ASCIUGAMANI LEAN

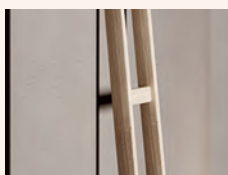

- In quercia massiccia di 20 mm di spessore

COD	LEGNO MASSELLO
XML	PVP -

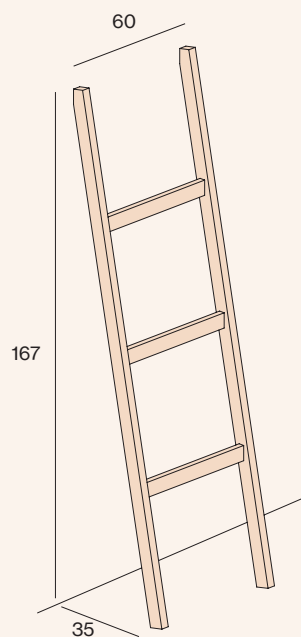

Nuovo catalogo VASCHE 2023

DECOSAN

consultare su [www.decosan.com](http://www.decosan.com)

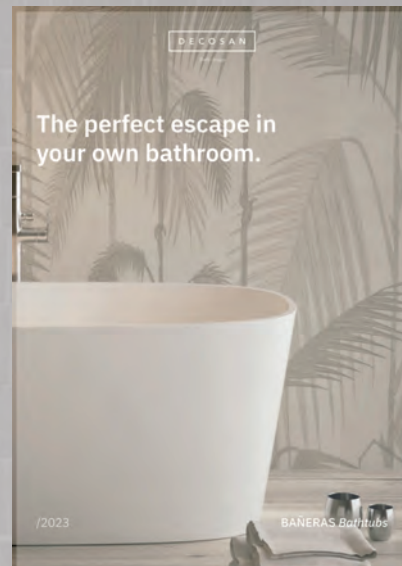



Catalogo esclusivo COLLEZIONI DI BAGNO

DECOSAN

consultare su [www.decosan.com](http://www.decosan.com)







# 07 Colori

Colori e finiture che trasmettono emozioni.

**Blanco Opaco**

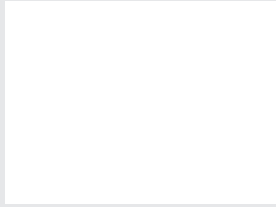

**Negro Opaco**

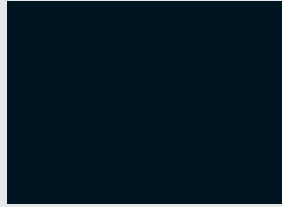

**Beige Opaco**

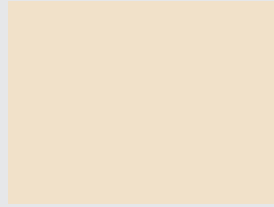

**Tierra Opaco**



**Caqui Opaco**

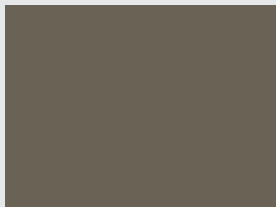

**Cuarzo Opaco**



**Moka Opaco**

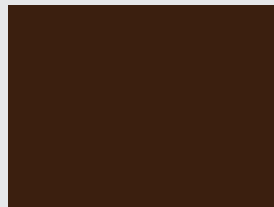

**Perla Opaco**

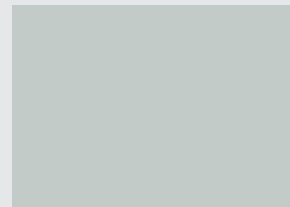

**Piedra Opaco**



**Acero Opaco**



**Antracita Opaco**



**Burdeos Opaco**



**Océano Opaco**



**Menta Opaco**



**Oliva Opaco**



**Terracota Opaco**

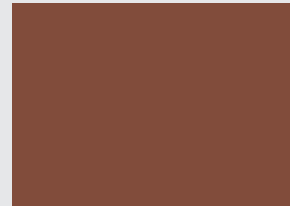

**Albero Opaco**



**Rosa Opaco**

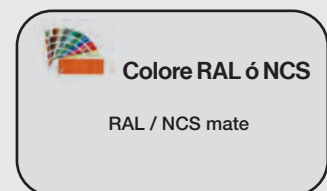
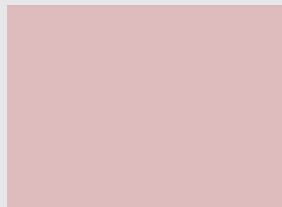

**Blanco Lucido**

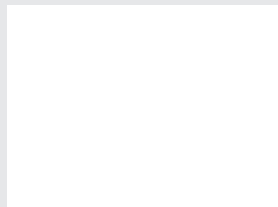

**Negro Lucido**

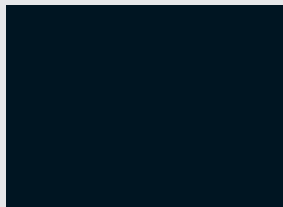

**Beige Lucido**

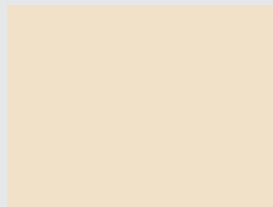

**Tierra Lucido**



**Caqui Lucido**

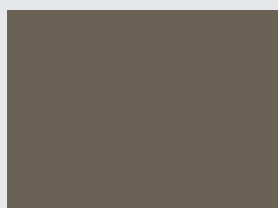

**Cuarzo Lucido**



**Moka Lucido**

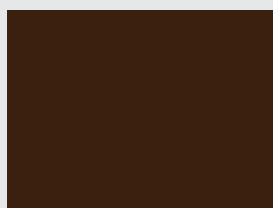

**Perla Lucido**

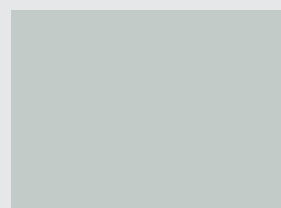

**Piedra Lucido**

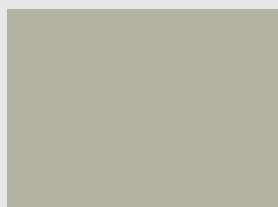

**Acero Lucido**



**Antracita Lucido**



**Burdeos Lucido**



**Océano Lucido**



**Menta Lucido**

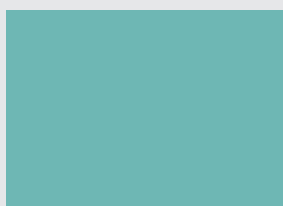

**Oliva Lucido**



**Terracota Lucido**

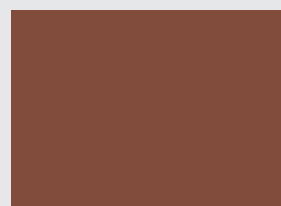

**Albero Lucido**



**Rosa Lucido**

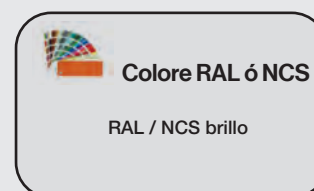
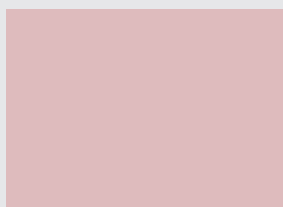

**Carbon**



**Brown**

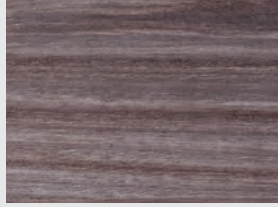

**Artic**

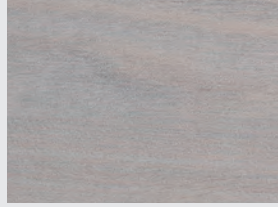

**Cocoa**



**Camel**

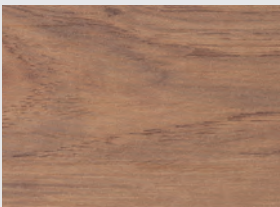

**Savana**



**Noce**

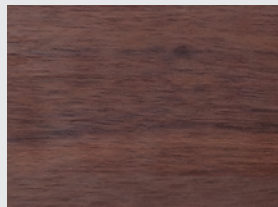

Pannello Multistrato Marino

**Ash**

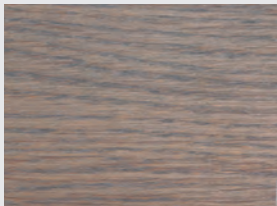

**Charcoal**

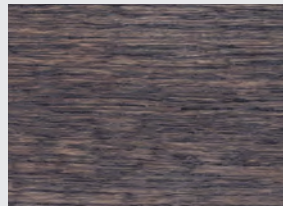

**Antique**

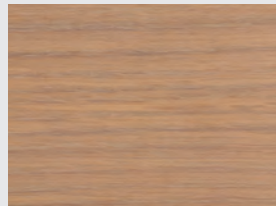

**Aceitado**

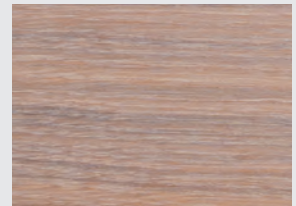

**Cherry**

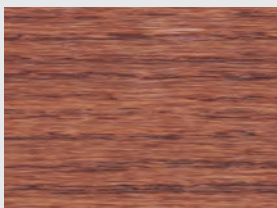

**Bourbon**



**Legno Rústico**

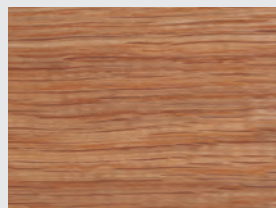

**Noce**

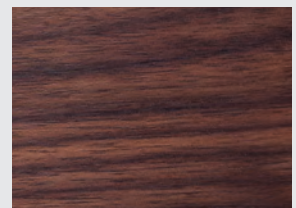



**Ash**



**Charcoal**

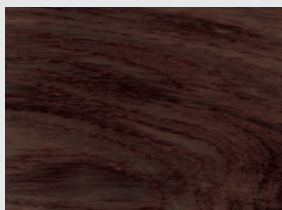

**Antique**

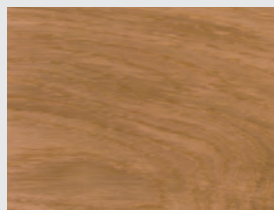

**Aceitado**

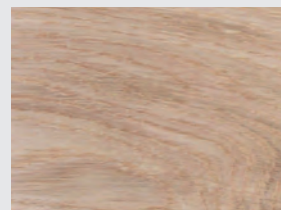

**Cherry**

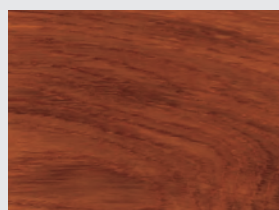

**Bourbon**

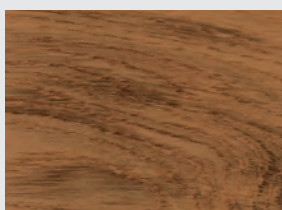

**Legno**



Ceramcolor

**Blanco**

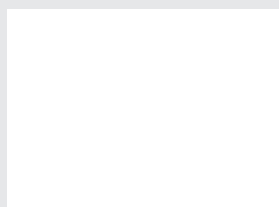

**Negro**

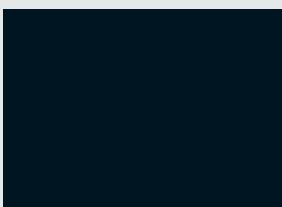

**Tierra**



**Cuarzo**

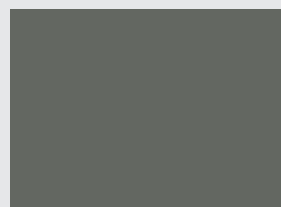

**Acero**



**Antracita**

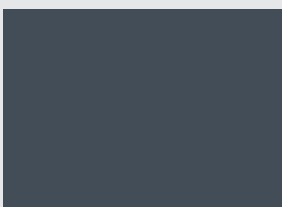

**Oliva**



**Blanco**

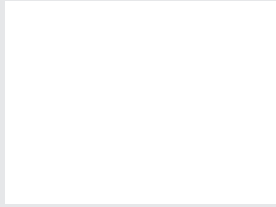

**Negro**

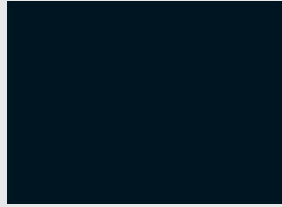

**Beige**

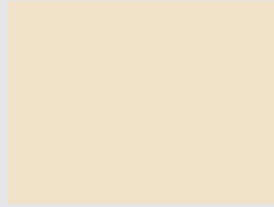

**Tierra**



**Caqui**

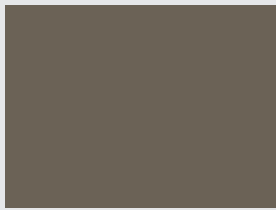

**Cuarzo**



**Moka**

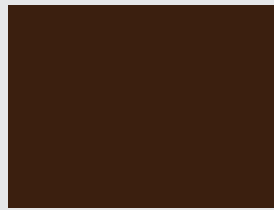

**Perla**



**Piedra**



**Acero**



**Antracita**



**Burdeos**



**Océano**



**Menta**

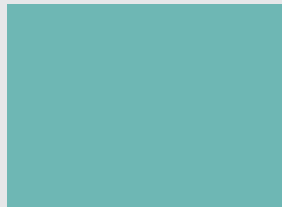

**Oliva**



**Terracota**

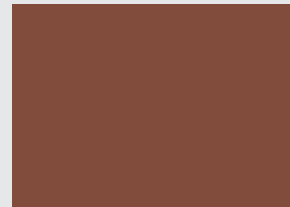

**Albero**



**Rosa**

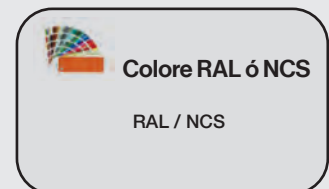
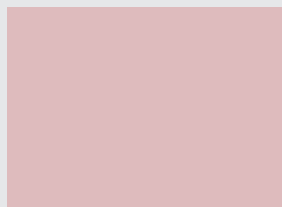

**Negro Compacto**



**Negro Marquina**

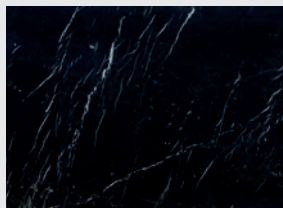

**Pietra Gris**



**Verde India**

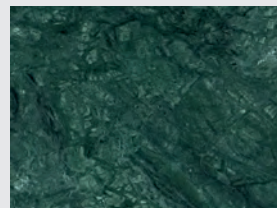

**Crema Marfil**

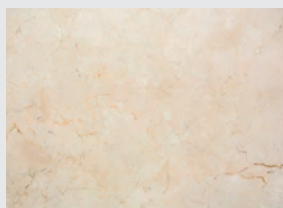

**Carrara**



## Metallo

**Oro Cepillado**

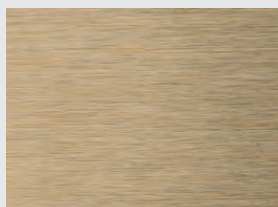

**Cobre Cepillado**



**Acero Cepillado**

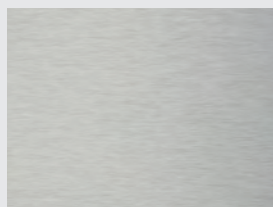

# Condizioni di vendita

Le seguenti condizioni sono valide per la vendita di prodotti di Artesania Baño, SL-DECOSAN. L'emissione di ordini da parte della società acquirente implica l'accettazione delle attuali condizioni di vendita. Qualsiasi modifica di queste condizioni sarà soggetta all'approvazione scritta di Artesania Baño, SL-DECOSANTO.

## Prezzi

I prezzi non includono l'IVA o altre tasse. I prezzi del catalogo possono essere modificati senza preavviso e sono validi in base alla tariffa in vigore il giorno della spedizione.

## Le tasse

Addebito sulla fattura secondo la normativa vigente. Gli impegni di pagamento devono essere effettuati in contanti secondo le condizioni di credito pattuite e secondo quanto stabilito dalla Legge 16/2009 del 13 novembre, sui servizi di pagamento.

## Condizioni di pagamento

Fino a quando non verrà concessa la classificazione e il rischio appropriati, tutte le operazioni saranno effettuate con pagamento anticipato.

## Operazioni successive

Il differimento del pagamento delle nostre fatture sarà concordato tra le due parti. Una volta scadute le scadenze concordate, siamo automaticamente autorizzati a contabilizzare gli interessi di mora al tasso dell'UNO PER CENTO al mese o frazione.

Le rate in attesa di fatturazione scadono sempre immediatamente quando l'acquirente viene dichiarato insolvente, se vengono avviate procedure concorsuali o fallimentari, se la vostra azienda viene ceduta o se vi è un cambio di proprietà.

In caso di mancato rispetto delle condizioni di pagamento e / o restituzione degli effetti negoziati, Artesania Baño, SL-DECOSAN rimborserà integralmente le spese di restituzione e di amministrazione, considerando annullate le condizioni concordate con il cliente (a causa di mancata compliance) e rinunciare agli effetti in sospeso.

## Prenotazione del dominio

La merce è considerata proprietà di Artesania Baño, SL / DECOSAN fino al completo pagamento della stessa da parte del cliente, con dominio riservato ArtesaniaBaño, SL / DECOSAN fino a quel momento.

## Giurisdizione

Questo rapporto sarà regolato dalla legge spagnola. In caso di controversia, le parti rinunciano espressamente a qualsiasi altro foro o giurisdizione a cui possono avere diritto e accettano di sottoporsi ai Tribunali di Barcellona.

## Ordini

Tutti gli ordini devono essere formalizzati mediante documento scritto. Essenziale per lavorazioni speciali:

- Allegare uno schizzo con le misure del prodotto richiesto.
- Pagare il 50% dell'importo al momento dell'accettazione dell'ordine. Il resto verrà pagato secondo le condizioni concordate.
- I prezzi non includono l'installazione o il presunto funzionamento.

## Garanzia

Si certifica che tutti i prodotti sono garantiti per due anni a causa di difetti di fabbricazione nelle normali condizioni di utilizzo e installazione, secondo il Regio Decreto Legislativo 1/2007 del 16 novembre, l'azienda che si impegna a riparare o sostituire i materiali le cui anomalie sono dovute queste cause.

Il diritto al risarcimento dei danni è escluso (qualunque sia l'atto giuridico fondamentale accettato) a meno che non sia dimostrato in modo affidabile che abbiamo risposto con premeditazione o negligenza grave. La garanzia non copre i difetti causati da uso improprio, installazione difettosa o impropria o difetti causati da cause di forza maggiore.

## Design

Artesania Baño, SL-DECOSAN si riserva il diritto di apportare senza preavviso qualsiasi modifica degli articoli in qualsiasi area delle caratteristiche tecniche, estetiche o di valutazione.

## Termini di consegna

Il tempo di consegna approssimativo è di 3 settimane per gli articoli del catalogo standard e di 4 settimane per quelli che sono soggetti a qualsiasi modifica che sarà speciale a meno che non sia specificato un altro tempo di consegna per motivi di produzione o pianificazione.

Eventuali ritardi nei tempi di consegna concordati non comportano l'esistenza del diritto al risarcimento dei danni o altre cause.

## Trasporto merci

- Quando la merce viaggia correttamente, Artesania Baño, SL / DECOSAN è esonerata da eventuali vizi o difetti che potrebbero essere imputabili al trasporto della merce.

- Quando la merce viaggia in modalità prepagata, il cliente deve notificare ad Artesania Baño, SL / DECOSAN per iscritto entro 24 ore dal ricevimento della merce, qualsiasi difetto o difetto imputabile all'agenzia di trasporto per facilitare la rivendicazione di responsabilità ai sensi della legge 16/1987 sul trasporto terrestre Gestione e RD 1.111 / 1990 con cui viene approvato il regolamento LOTT. - Il reclamo contro il vettore per danni o guasti deve essere presentato nell'atto di ricevimento dei pacchi purché il danno sia evidente ed entro 24 ore dal ricevimento, se il danno non è evidente, il reclamo o la prenotazione deve essere effettuato in la scrittura.

- La merce viaggia sempre a rischio e spese dell'acquirente, anche in caso di accordi particolari.

- Trasporto pagato:

Penisola da € 250.

alle Baleari da € 500.

alle Isole Canarie a partire da 1.500 euro.

a Ceuta e Melilla consultare le spese di spedizione.

Il prezzo di affrancatura è di € 15. In caso di spedizione singola di piani lavabo, specchi o lavelli che richiedono un imballo speciale, l'importo minimo sarà di 30 € netti.

## Rimborso

I resi saranno accettati solo ed esclusivamente per merce difettosa e / o erroneamente inviata da Artesania Baño, SL / DECOSAN. Qualsiasi reso deve essere sempre comunicato per iscritto e autorizzato da Artesania Baño, SL / DECOSAN

La restituzione della merce dovrà essere effettuata nella confezione originale ed in perfette condizioni e subirà un deprezzamento automatico minimo del 15% sull'importo fatturato per spese di gestione e magazzino, che potrà essere superiore a seguito del controllo.

## Integrità

È obbligo del destinatario controllare l'imballaggio e il prodotto al momento del ricevimento. In caso di osservazione di qualsiasi incidente al momento della consegna, annotare l'incidente sulla bolla di consegna e inviare una comunicazione scritta ad Artesania Baño, SL / DECOSAN accompagnata da alcune fotografie.

Nel caso in cui non venga rilevato alcun difetto visibile al momento dell'arrivo, annotare sulla bolla di consegna "conforme all'esame" ed effettuare tale verifica entro un termine massimo di 24 ore, procedendo se opportuno ad inviare il reclamo con le stesse condizioni scritte e con immagini che consentono di valutare l'accaduto. In caso di mancata osservanza delle relative procedure, la società non accetterà ad alcun reclamo in merito in quanto la copertura del trasporto declina ogni responsabilità ai sensi della Legge 16/1987 della Gestione dei Trasporti Terrestri e RD 1.111 / 1990 con cui vengono approvate le normative LOTT.

## Riservatezza e protezione dei dati

In ottemperanza alle disposizioni della Legge Organica 15/1999 del 13 dicembre sulla Protezione dei Dati Personali e del REGOLAMENTO (UE) 2016/679 DEL PARLAMENTO EUROPEO E DEL CONSIGLIO del 27 aprile 2016 (GDPR), i dati di natura personale forniti dall'acquirente faranno parte della pratica del venditore, i cui scopi sono il mantenimento del rapporto contrattuale, la gestione delle vendite e gli incassi. Il venditore tratterà questi dati con la massima riservatezza e si impegna a non utilizzarli per uno scopo diverso da quello per cui sono stati raccolti, nonché ad essere conservati con le misure che ne garantiscono la sicurezza a terzi non autorizzati. L'acquirente ha il diritto di accesso, rettifica e cancellazione inviando una comunicazione scritta a Artesania Baño, SL / DECOSAN Ctra. Laureà Miró, 385-387 - 08980 Sant Feliu de Llobregat, Barcellona o tramite e-mail a rgpd@nofer.com.

## Dimensioni consigliate per l'installazione sanitaria

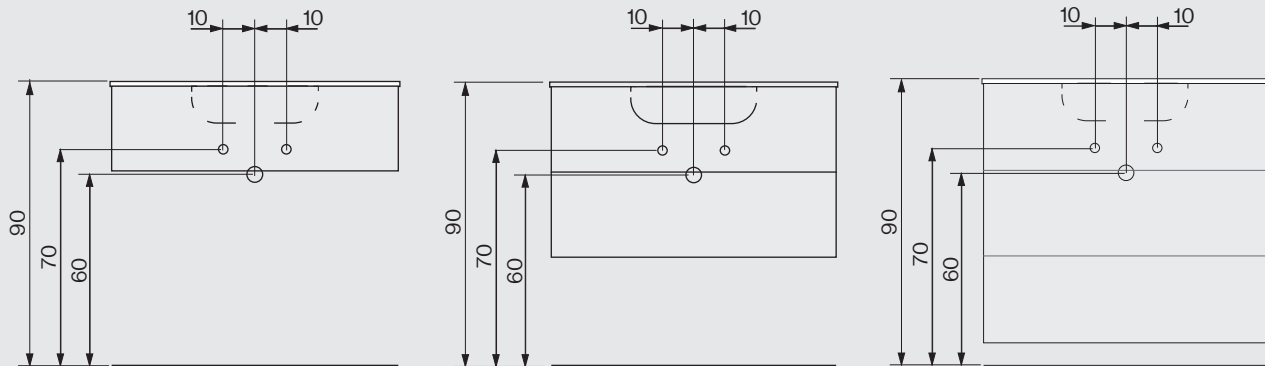

I mobili di questa altezza non supportano il sistema DecoSpace

## Decospace System

**Con piano lavabo integrato**

**Lavabo da appoggio**

**Con registrazione sanitaria**

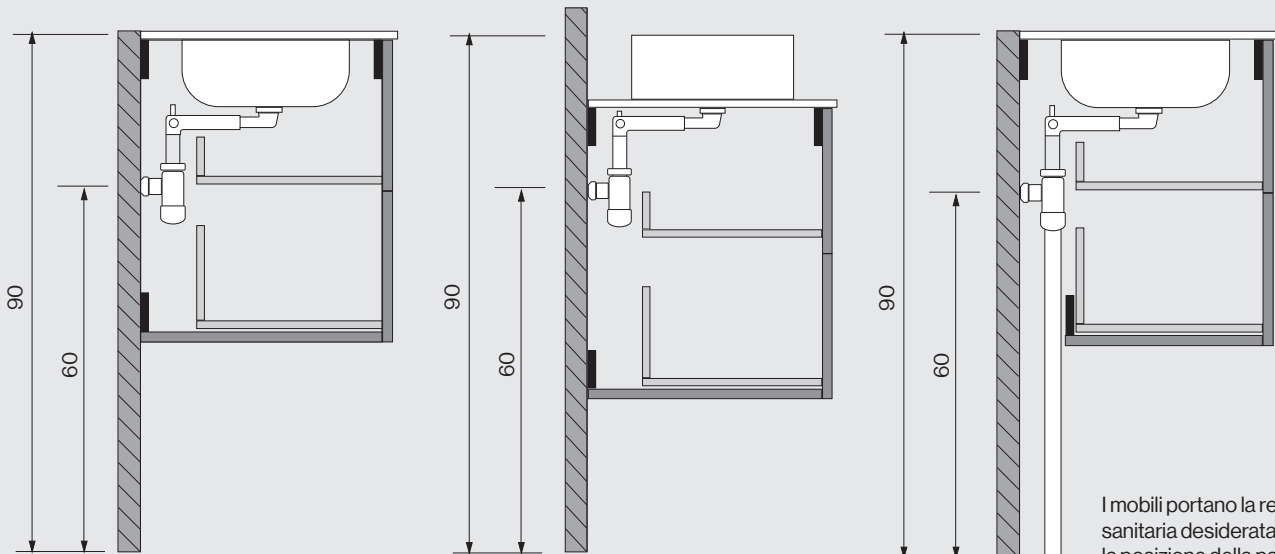

I mobili portano la registrazione sanitaria desiderata per la posizione della parete o del pavimento.

Tutti gli articoli sono forniti con cacciavite e gli attacchi necessari per il loro posizionamento, nonché un manuale di montaggio per la sua corretta messa in servizio.

DECOSAN

Bath design



# DECOSAN

## DECOSAN CENTRAL

Ctra. Laureà Miró, 385-387  
08980 Sant Feliu de Llobregat  
Barcelona – España  
tels. +34 933 378 616, +34 933 378 187  
decosan@decosan.com  
www.decosan.com

## DECOSAN BARCELONA

Showroom Contract. Rambla Catalunya, 43  
Principal, 1ª - 08007 Barcelona - España  
+34 640 04 47 45  
info@wecontractbcn.com

## DECOSAN MILANO

Via Torino, 10 – 20060 Liscate  
Milano – Italia  
+39 0249796141  
cmarconi-bocchi@nofer.com

## DECOSAN MOSCÚ

107113, Moscow - Shumkina str. 26a str.4 Russian  
Federation  
+7 (495) 602-05-85  
info@nofer-aporici.ru

## DECOSAN DUBAI

Office # 1, Industrial Area 18, Maliha Road, P.O. Box  
4316, Sharjah, UAE  
+971 65467420  
info@mena-gate.com



NOFER



DECOSAN

BOCCHI SafeWORK

agetar, s.a.

