

DECOSAN

# Bath inspirations





Porque a beleza é  
simplesmente.

DECOSAN

Bath design







Nós concebemos a casa de banho como o espaço no qual a pessoa se encontra ela mesma de uma forma íntima, natural, sem filtros.

Queremos dizer a casa de banho como oportunidade de recomeçar todos os dias, de se reconhecer e começar de novo com novos desafios e esperanças.

Queremos dizer a casa de banho com a alma, onde o produto tem vida própria e uma harmonia perfeita entre beleza e funcionalidade.

Entendemos a casa de banho como o espaço no qual sua essência contribui para tornar a vida melhor.

DECOSAN

Bath design

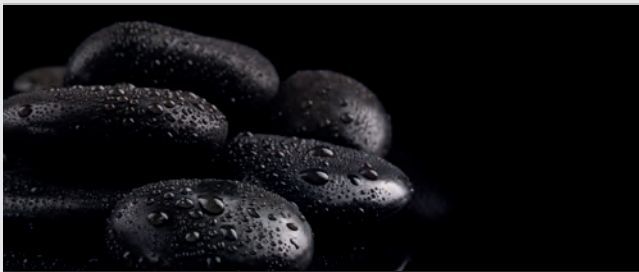

|                        |           |
|------------------------|-----------|
| <b>00. Bath design</b> | <b>11</b> |
| Nossa essência         | 12        |
| Materiais com alma     | 16        |
| Nossos materiais       | 18        |
| P + D + I              | 20        |
| Nossos conceitos       | 22        |
| Showroom Profissional  | 25        |
| Nossos designers       | 26        |

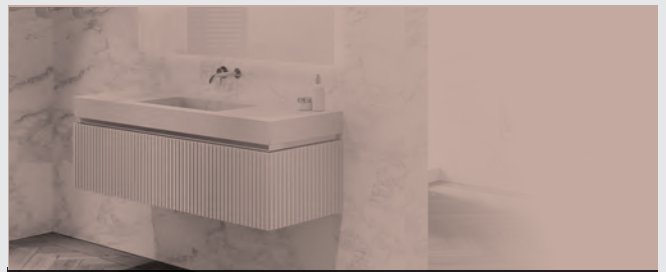

|   |                       |
|---|-----------------------|
| <b>01. Atelier. Móveis de casa de banho</b> | <b>29</b>             |
| Olympia: Estético.....                      | 30 - Técnico .....104 |
| Diamond: Estético.....                      | 44 - Técnico .....112 |
| Best: Estético.....                         | 62 - Técnico .....122 |
| Queen: Estético.....                        | 80 - Técnico .....132 |
| Alma: Estético.....                         | 88 - Técnico .....140 |
| Acessórios Atelier                          | 148                   |



|                           |            |
|---------------------------|------------|
| <b>04. Espelhos</b>       | <b>294</b> |
| Lisos                     | 300        |
| Luz de fundo              | 301        |
| Retroiluminação frontal   | 304        |
| Estrutura de metal        | 306        |
| Madeira emoldurada        | 308        |
| Armários de espelho       | 309        |
| Complementa o teu espelho | 310        |



|                       |            |
|-----------------------|------------|
| <b>05. Iluminação</b> | <b>314</b> |
| Luzes de espelho      | 318        |
| Iluminação decorativa | 320        |





|                            |                         |
|----------------------------|-------------------------|
| <b>02. Casual . Móveis</b> | <b>155</b>              |
| <b>de casa de banho</b>    |                         |
| Play: Estético.....        | 156 - Técnico ..... 230 |
| Step: Estético.....        | 214 - Técnico ..... 252 |



|                       |            |
|-----------------------|------------|
| <b>03. Bancadas</b>   | <b>258</b> |
| Padrão integrado      | 262        |
| Custom integrado      | 268        |
| Lavatório de bancada  | 276        |
| Totens                | 283        |
| Bancadas planas       | 284        |
| Acessórios de bancada | 292        |

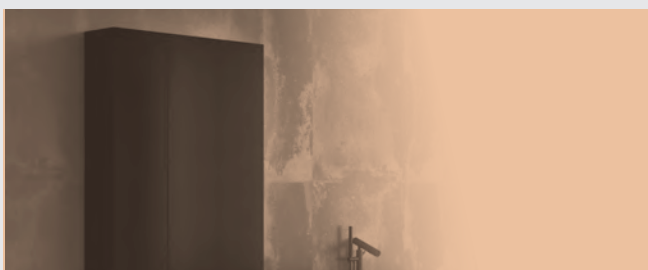

|                       |            |
|-----------------------|------------|
| <b>06. Auxiliares</b> | <b>322</b> |
| Colunas               | 328        |
| Armários              | 330        |
| Prateleiras           | 332        |
| Toalheiros            | 334        |
| Auxiliares Atelier    | 336        |

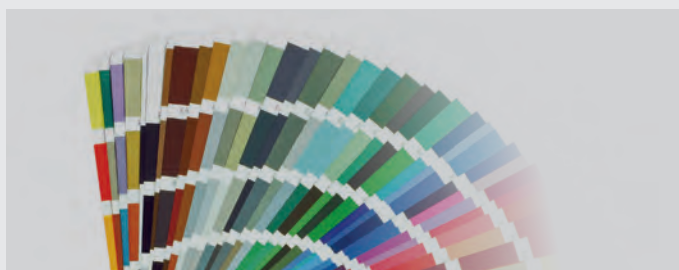

|                      |            |
|----------------------|------------|
| <b>07. Cores</b>     | <b>340</b> |
| Termos de venda      | 348        |
| Manual de instalação | 349        |

A perfeição é alcançada, não quando  
não há mais nada a acrescentar, mas  
quando não há mais nada a tirar.

Antoine de Saint-Exupéry (1900-1944)  
Escritor e poeta francês



# 00 Bath design

DECOSAN

Bath design



## Nossa essência

---

A Decosan, empresa especializada na fabricação de móveis e acessórios para casa de banho, pertence ao grupo empresarial Nofer.

Após 35 anos de experiência, hoje temos um tecido industrial muito poderoso com uma planta de produção de 2200 m<sup>2</sup>, um escritório central e um showroom com 1200 m<sup>2</sup> e um shopping logístico com mais de 3000 m<sup>2</sup> o que nos permite exportar para mais de 70 países.

DECOSAN

Milão

DECOSAN

Moscou



DECOSAN

Barcelona

DECOSAN

Dubai



Uma indústria 100% Made in Barcelona onde o artesanato e a tecnologia se fundem para criar soluções únicas com atenção especial aos detalhes.









## Materiais com alma

---

Como fabricantes, seleccionamos cuidadosamente a matéria-prima com que trabalhar, contribuindo com o nosso know-how artesanal, ao qual aliamos a máxima tecnologia industrial de que dispomos na nossa unidade de produção em Barcelona.

Respeitar o produto e tratá-lo bem nos permite manter a essência de cada matéria-prima em nosso produto final.



# Nossos materiais



## Madeira Nature

Acabamento decorativo que se aplica a painéis de aglomerado de madeira e que apresenta várias cores e acabamentos, com muito bom desempenho mecânico e resistente a arranhões, solavancos e abrasão.

## Solid Surface (Cristalplant)

O Solid Surface é um material de última geração composto por dois terços de minerais naturais e resinas à base de BIO derivadas do milho. O resultado é um material antibacteriano não poroso, sedoso e quente ao toque. A sua estrutura e composição tornam-no reparável.

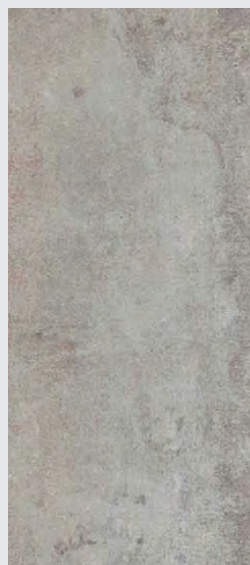
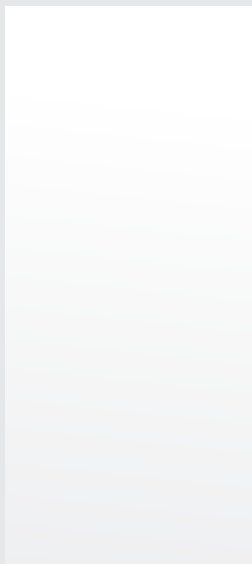

## Microcimento

Material compósito decorativo à base de cimento e pigmentos minerais para um acabamento compacto, muito resistente e fácil de limpar.

## Madeira Maciça

Madeira de carvalho 100% natural. O tampo de carvalho maciço é fabricado em ripas, ou seja, colando tiras de 8 a 15 cm. Produto natural de extraordinária beleza que respeita as irregularidades do tronco da árvore e é protegido com óleos naturais que lhe conferem grande durabilidade mantendo ao mesmo tempo o seu aspecto natural.

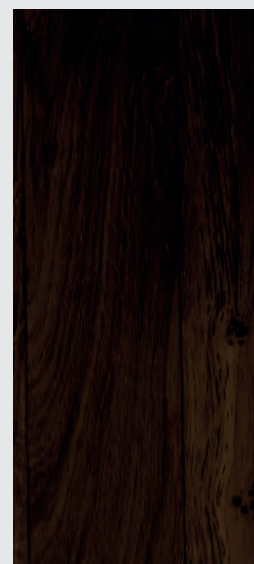

## Fibralac

Material que pela sua composição e características de alta densidade é ideal para obter acabamentos lacados mate e de alto brilho. É feito de fibras de madeira prensadas a seco com resinas sintéticas que agem como aglutinante, oferecendo uma estrutura compacta e muito lisa.

## Prancha Madeira Marinha

Prancha marinha multicapa com colas fenólicas de grande estabilidade dimensional e resistência à umidade. Carvalho natural, carvalho rústico ou folheados de noz são revestidos a este material dependendo do acabamento desejado. O acabamento final é conseguido com óleos naturais respeitando a textura com máxima proteção contra agentes externos.

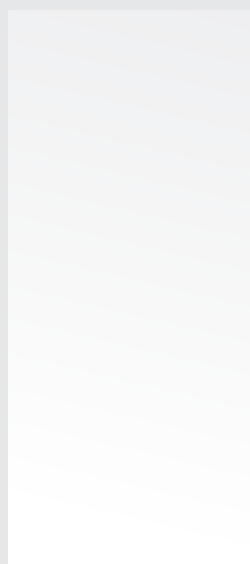

## Solid Mineral

Material composto por cargas minerais naturais e resinas de alta resistência. É um material não poroso, antibacteriano, leve e com toque muito sedoso.



### **Pedra Natural**

Rocha calcária compacta e cristalizada 100% natural extraída de pedreiras. Uma ampla gama de cores está disponível com um tratamento anti-manchas com acabamento fosco que impede a absorção. É um produto natural e irrepetível, pelo que as amostras de cores são apenas indicativas.



### **Cerâmica**

Pasta de substância argilosa de estrutura compacta, moldada e submetida a diferentes processos de cozedura que garantem a vitrificação da superfície, o que lhe confere extraordinária qualidade mecânica, higiénica e higiénica. Muito fácil de manter.

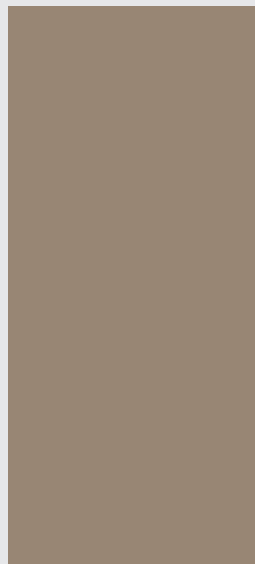

### **Resina**

Novo material sintético de alta qualidade e nivelamento. Sua cor cerâmica branca o torna ideal para as novas linhas de móveis de casa de banho. Seu toque é quente, é fácil de limpar e tem longa duração, além de ser resistente à degradação.

### **Ceramcolor**

Esmalte colorido de alto desempenho à base de nanopartículas com altas propriedades antibacterianas, não poroso e com grande resistência mecânica a manchas e agentes químicos. É para aplicação em porcelana e pedra compacta.

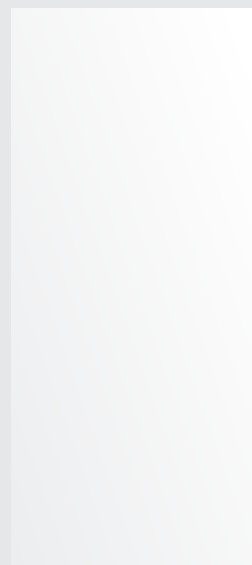

### **Glass Blanco**

Vidro de cor branca, gerando um vidro branco opaco com acabamento brilhante.



### **Cristalcolor**

Vidro ótico totalmente transparente que é colorido e vitrificado no forno. As pias termoformadas são alcançadas em fornos a altas temperaturas, conseguindo uma pia com uma queda progressiva e uma textura mate e sedosa ao toque.



### **Metal Inox**

O aço inoxidável é um aço de alta liga que contém cromo e outros ligantes que lhe conferem uma característica de grande resistência à corrosão. Os produtos de aço inoxidável são submetidos a polimento ou tratamentos de superfície acetinados, mas também podem ser banhos coloridos para obter outros acabamentos.



Nossos materiais

## P+D+I

# Pesquisa e desenvolvimento e inovação

---

O tratamento dos materiais e o máximo envolvimento no desenvolvimento de novos produtos e sistemas permitem-nos apresentar propostas inovadoras com identidade própria.

Nosso compromisso com a melhoria contínua tem nos permitido implantar novos sistemas e tecnologias que melhoram a qualidade de uso e o conforto de cada produto.





# Nossos conceitos



## SOB MEDIDA

Esta coleção permite a fabricação sob encomenda. No caso de medidas intermediárias de altura e largura, calcule o preço da próxima medida superior.



## ANTRACITE FULLCOLOR

Conceito de design de interiores onde todos os materiais do interior do móvel são desenhados em antracite. O gabinete com acabamento lacado é lacado internamente em antracite.



## ATELIER SYSTEM

Nos acabamentos marítimos, as peças são selecionadas de forma numerada para respeitar continuidade do grão em todo o gabinete.

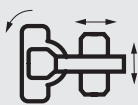

## BLUM 3D BISAGRAS

Las bisagras tienen regulación de altura, profundidad e inclinación para un ajuste perfecto.



## 4D GAVETAS

Gavetas Hettich ou Blum em metal antracite e perfil extrafino de 12 mm com 4 regulagens. Os guias possuem extensão total e sistema de frenagem progressiva.



## DECOBUILD SYSTEM

Móveis feitos com placas de 19 mm colados com cutelos obtendo uma estética limpa sem encaixes visíveis e oferecendo maior resistência e durabilidade.



## DECOFIX SYSTEM

Sistema de fixação de parede de alta segurança com o qual as resistências de carga são mais de 240 kg.



## DECOSPACE SYSTEM

Sistema que fornece o fornecimento de um sifão que economiza espaço e uma válvula click clack em cromo polido. Esta solução evita o colapso da gaveta superior melhorando a capacidade de armazenamento e a estética interna, pois as estruturas estão ocultas.



## DURALACK SYSTEM

As cores lacadas contêm aditivos de endurecimento que permitem que o acabamento final seja altamente resistente à fricção e abrasão.



## PRATELEIRAS DE VIDRO INTERIORES

As prateleiras de vidro interiores têm 6 mm de espessura. No caso de vitrines e armários, as prateleiras são cinza fumê.



## ESPELHO DE AUMENTO MÓVEL

Você pode equipar o espelho com um espelho de aumento magnetizado x3 que permite colocá-lo na área habilitada do espelho e ajustar sua posição.



## ESPELHO DE AUMENTO

Você pode personalizar seu espelho com um espelho de aumento x5 integrado com iluminação LED de perímetro.



#### ESPELHOS COM ANTIEMBAÇANTE

Você pode equipar o espelho com um sistema antiembaçante. Uma película térmica aderida à parte posterior do espelho evita a condensação de água no espelho, melhorando o conforto de utilização e o reflexo perfeito do espelho.



#### ESPEJOS COM BLUETOOTH

Você pode vincular seu celular ao espelho por bluetooth e curta sua música no banho.



#### ESPELHOS COM LUZ FRIA E / OU QUENTE

Você pode personalizar seu espelho com a temperatura de cor desejada, mais quente ou mais fria, de 2700°K a 5500°K. Você pode até equipar seu espelho com um sensor de toque que permitirá que você altere a temperatura da cor, seja ela quente, neutra ou fria.



#### ESPELHOS COM SENSOR ON/OFF

Esta opção permitirá que você ligue / desligue o espelho e altere a intensidade da luz, se necessário, com uma leve pressão no sensor de toque.



#### PUSH AND SLOW

As gavetas com sistema de abertura Push sem puxadores possuem um sistema de sincronização que permite a sua abertura pressionando em qualquer parte da frente. Ao mesmo tempo, o fechamento é progressivo e silencioso.



#### PUSH PORTAS SEM PUXADOR

As portas das colunas e armários possuem sistema de expulsão por push que também pode ser utilizado apenas como retentor.



#### SENSOR ANTIEBAÇANTE

Sensor ON / OFF para folha antiembaçante.



#### SISTEMA DE SUSPENSÃO DE SEGURANÇA ANTI-QUEDA 150 KG

As colunas e armários possuem sistema de suspensão de segurança antidesgaste com capacidade de carga de 150 Kg.



#### SISTEMA SCREEN COM SENSOR ON / OFF

A tecnologia nos permite replicar a tela do seu celular no espelho. Com isso, você pode reproduzir facilmente no espelho todo o conteúdo do seu celular como vídeos e fotos. Compatível com IOS e Android.



#### WOOD PROTECT SYSTEM

As madeiras do prancha marinha são protegidas de agentes externos com óleos naturais que respeitam a textura e natureza da madeira.



Nossos conceitos



Made in Barcelona

Um espaço para compartilhar  
experiências localizado no  
coração de Barcelona, uma  
cidade de design e inspiração.





## Showroom Profissional

---

Workshops, mesas redondas, seminários e diversas atividades para estar ao lado do profissional com quem construir o futuro da decoração de casas de banho e de interiores.



Inspire-se. Deixe-nos levá-lo a um espaço com alma, imagine a casa de banho dos seus sonhos, convidamos você a tocá-lo, senti-lo e torná-lo seu.

# Nosso designers

---

Os designers trabalham de acordo com um processo de design que começa com a interpretação ou detecção de um problema ou necessidade e culmina com a produção ou construção da solução para esse problema.



## *CirculoCuadrado*

CirculoCuadrado é o estúdio de design de interiores formado por Ismael Barajas e Maribel Caballero, graduados em Design de Interiores em Barcelona.

Depois de uma longa carreira individual, inauguraram o atelier conjunto em 2006. Definem-se num estilo de influência minimalista, na procura constante da ordem visual e da aplicação de materiais nobres.

CIRCULO<sup>®</sup>  
CUADRADO

## *Decosan Studio*

Nossa equipe desenvolve projetos e conceitos com visão global. Materiais, tecnologia, forma, ergonomia, linguagem, comunicação visual e criatividade são elementos que consideramos em todos os projetos para alcançar o produto ideal.





# 01 Atelier Móveis de casa de banho

Atenção aos detalhes,  
habilidade na forma de estilo.

# Olympia

O estilo que nunca  
deixou de ser.





▲ Banheira  
*Orion Solid Surface*



Luz decorativa  
*Ledpoint*



Acessório  
*Toalheiro na parede*







Móvel  
1 Gaveta / acabamento de friso lacado / borda de Acero Cepillado



Espelho retroiluminado  
Spined





▲ Móvil suspenso alto 35 cm



Beige



Perla



Acero



Piedra



Tierra



Caqui



Albero



Moka



Antracita

- ▲ Personalize a cor do seu mobiliário com 18 cores padrão ou de mesa RAL/NCS

Banheira

▼ *Borealis Solid Surface*

Móvil

*1 baú + gaveta interna / acabamento em friso em nogueira/ pescoço em Oro Cepillado*



Superfície de trabalho  
*Pedra Natural Negro Marquina*

Espelho retroiluminado  
*Framed*



▼ Tampo com lavatório integrando Plus em  
Pedra Natural Negro Marquina



▼ Guarda-roupa do altura 54 cm com baú e gaveta interna



▼ Estrutura de gabinete quadrada em Prancha Madeira Marinha



▲ Sistema Decospace.  
Gaveta na parte superior sem acabamento.  
Válvula de economia de espaço e sifão includes.

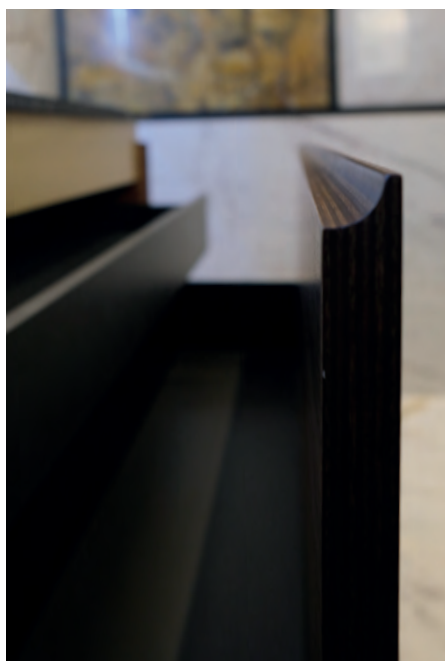

▲ Gavetas extra finas com sistema de extração total e fechamento silencioso.



▲ Acessório  
*Colonna porta de vidro fumé e perfil  
de vitrine em metal preto fosco*





#### Móvel

1 gaveta / acabamento em carvalho rústico liso / puxador lacado Negro fosco



#### Plano de trabalho

Tampo em Prancha Madeira Marinha de carvalho acabamento Legno Rústico Lavatório de bancada em aço inoxidável



OLYMPIA

#### Espeho retroiluminado

Circled





◀ Personalize seus móveis Olympia com textura friso liso.



OLYMPIA

▼ Textura de friso



▲ Textura macia

Personalize o puxador de móvel com acabamentos metálicos, lacado em qualquer cor ou madeira natural em 8 cores diferentes.



MESA MADEIRA MARINHA

LACA

# Diamond

O corte do diamante  
o torna uma joia.

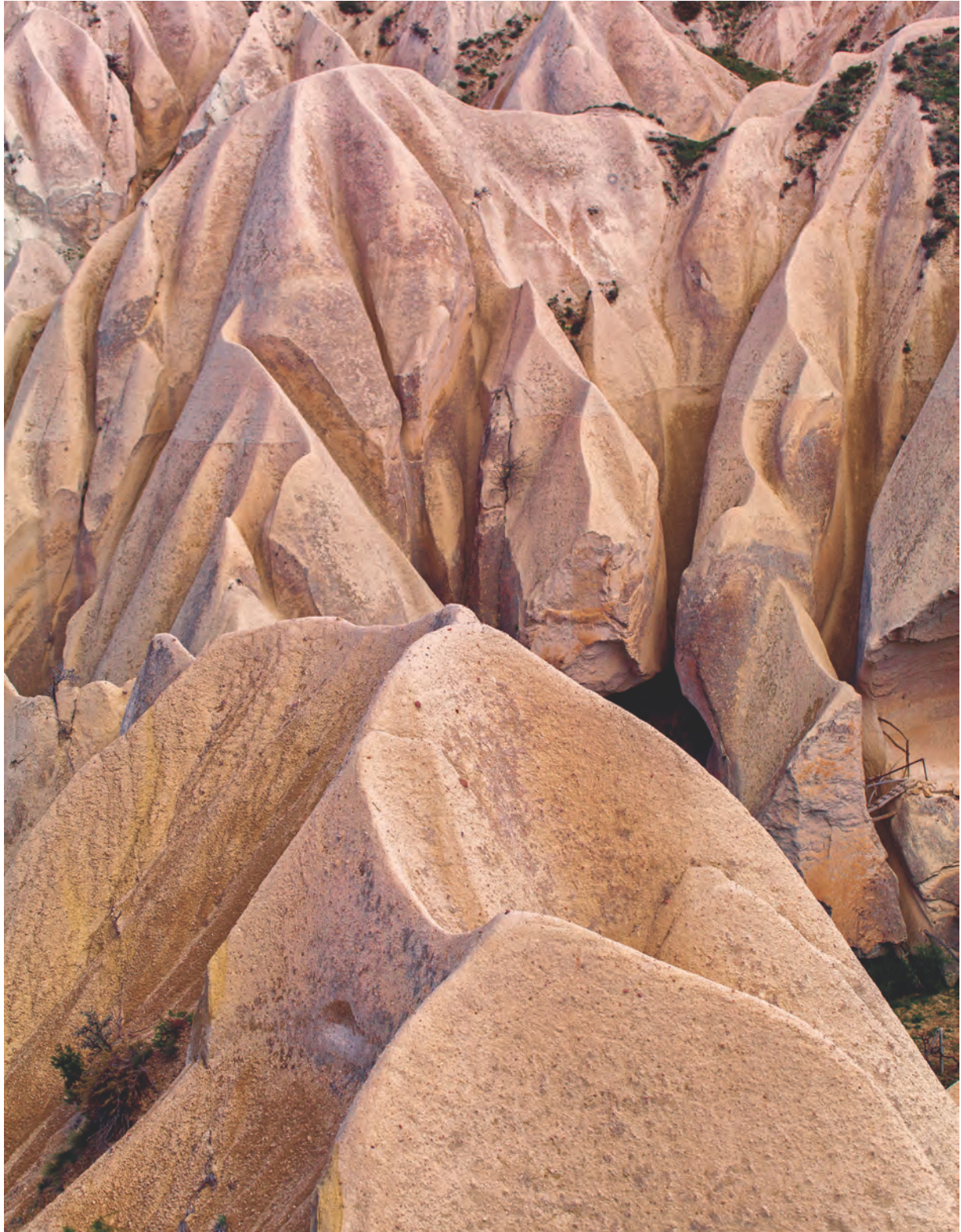



116

Móvel ▶

*Composição de 3 gavetas e 2 nichos decorativos / acabamento Nogueira e preto fosco / puxador Inglete Diamond*



274

Bancada integrada  
*Cristalcolor Negro*



338

Banheiro  
*Andrómeda Solid Surface*



320

Luz decorativa  
*Ledarc*











◀ Espelho retroiluminado  
*Spinled com espelho de aumento móvel*

Complemento  
*Prateleira decorativa com divisória interna móvel*

Luz decorativa  
*Ledarc mate preto*

▼ Atelier design  
*O grão da madeira continua ao longo de todo  
o comprimento do gabinete*





119



274



303



320

Móvel ▶

*2 baús / acabamento lacado /  
puxador Push*

Plano de trabalho  
*Cristalcolor integrado*

Espelho retroiluminado  
*Spinled*

Luz decorativa  
*Ledarc*







- ▲ Tampo de trabalho integrado em vidro ótico com textura opaca e personalizável em qualquer cor da tabela RAL

▼ Lados oblíquos  
efeito diamante



▼ Efeito de diamante externo  
particular chanfro de perímetro

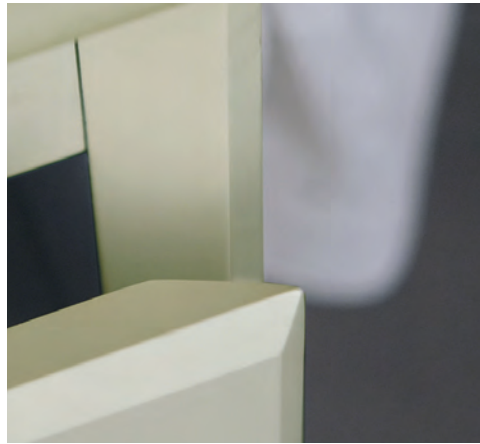

▲ Detalhe do diamante interno  
cego



Móvel

2 gavetas / painel com acabamento em  
Prancha Madeira Marinha / puxador Diamond



Plano de trabalho

Topo plano, Solid Surface  
Lavatório de bancada de Solid Surface





Espelho

*Espelho Retroled*

*Espelho de aumento móvel*



Luz decorativa

*Ledcirc*



Banheira

*Orion Solid Surface*



Acessório

*Dobro porta de Prancha*

*Madeira Marinha*





◀ Granulação contínua, respeitando a malha da madeira

▶ Detalhe do puxador Diamond. Chanfro duplo interno e externo que reproduz as dimensões de um diamante







▲ Móvel  
*Composição decorativa de canto com tampo de Pedra Natural e 1 cômoda com tampo lacado*

 272

 116

Espelhos enquadros  
*Metal color negro*

 306-307



Espelho  
*Camerino 2 portas*

Luz decorativa  
*Ledcirc*





◀ Armário espelho com portas assimétrico com lados espelhados e extrator oculto



◀ Módulo add-on com bancada lacada



▲ Bancada  
suspensa com lavatório  
integrado em Pedra Natural

Espelhos  
Espelhos Metalround e  
Metalroundled

Luz decorativa  
Ledcirc



DIAMOND

# Best

Arquitetura pura,  
fusão de elementos.

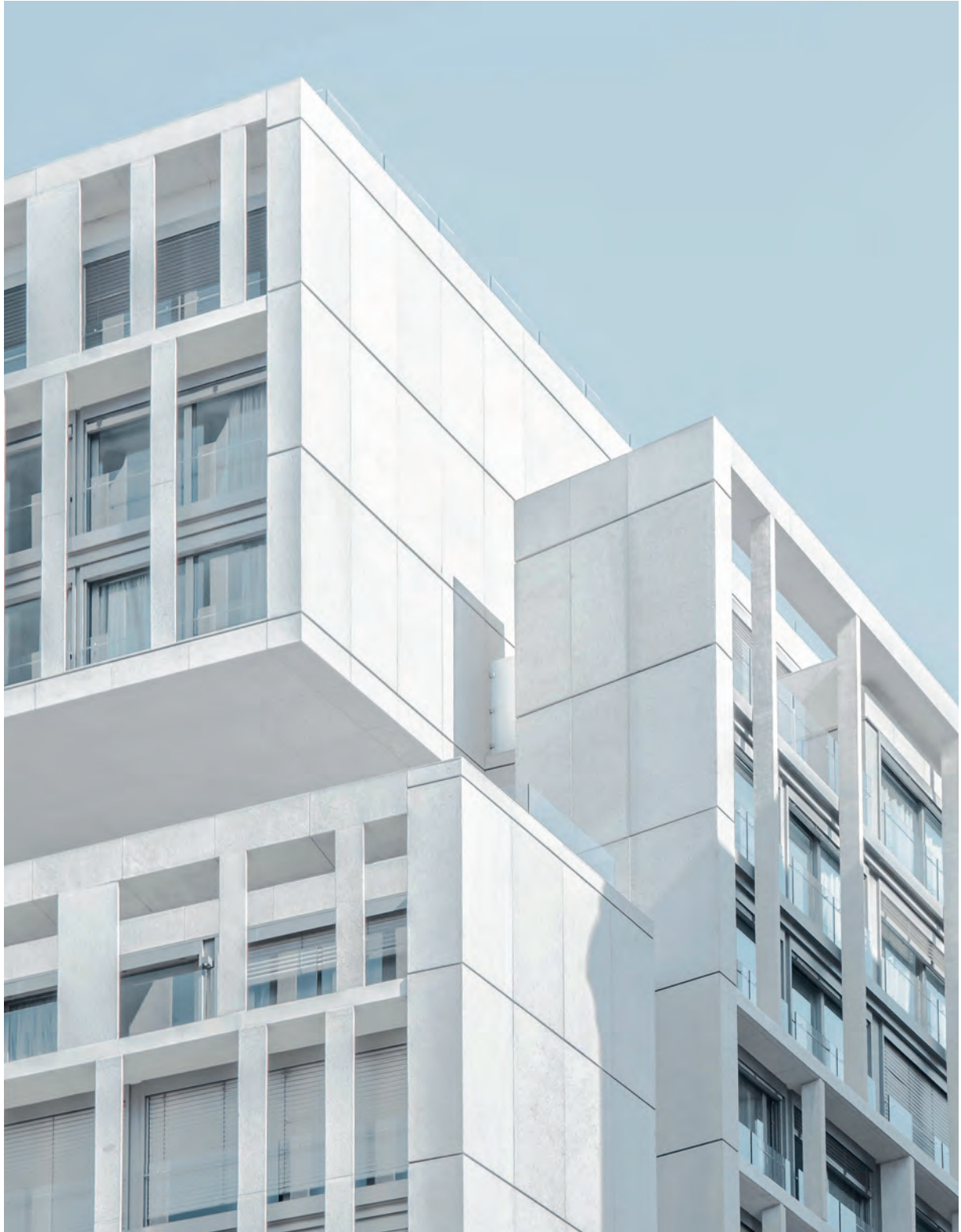









- ◀ Personalização led.  
Espelho Roundled com led  
perímetro personalizável  
dentro temperatura e cor

- ◀ Integração de cores.  
Lavatório de cerâmica colorida.  
Tampo Ceramcolor.  
Móveis lacados.  
Vários elementos e  
materiais com a mesma cor

▼ A 45° alça de esquadria e estrutura



Auxiliares ►  
*Composição das colunas  
porta decorativa e de  
madeira com prateleira dupla.  
Carvalho Legno Rústico*





▲ Móvel  
2 baús e 1 gaveta interna / puxador  
Push / carvalho acabamento Legno  
Rústico

Bancada integrada  
Solid Mineral

Espelho frontal com  
iluminação  
Duoled

Luz decorativa  
Ledcirc



▲ Tampo integrado Regatta com acabamento em Pizarra natural.

Prateleira de metal com tampo  
de mesa duplo em Prancha  
Madeira Marinha acabamento  
Legno Rústico ▶



▼ Detalhe extrator  
Estrutura de canto 45°



▼ Gavetas de metal 4D com extração total e fechamento silencioso



▶ Detalhe de alça de canto





127

Móvel ▶

2 gavetas / puxador  
Inglete / acabamento lacado



291

Plano de trabalho  
Pedra Natural plana  
pias de bancada



306

Espelho com  
iluminação frontal  
Metalroundled



321

Luz decorativa  
Ledcirc









▲ Materiais e cores.  
Equilíbrio estético



◀ Luz decorativa  
*Ledpoint*



◀ Auxiliar  
*Prateleiras de metal  
com prateleira dupla  
envernizado*



▲ Móvel  
*Unidade de armazenamento auxiliar  
com base superior em Solid Mineral*



130

Espelho  
*Corner*



308

Auxiliar  
*Prateleira decorativa*



333



Móvel  
1 baú + 2 gavetas / puxador Push /  
acabamento em Prancha  
Madeira Marinha



Plano de trabalho  
Mineral Solid plano. Lavatório de canto de  
abraço em madeira maciça mineral com  
prateleira lateral decorativa



Espelho  
Triled com sistema Screen



▼ Especialistas em Solid Surface. Banheiras, bancadas, pias



▲ Arquitetura de Solid Surface. Projetos personalizados



BEST



# Queen

Estilo único e distinto.





308

Espelho enquadrado  
*Luxor prata*

291

Topo plano  
*Pedra Natural Carrara*

136

Móvel  
*1 gaveta / puxador Queen /  
acabamento lacado*





137

Móvel

4 gavetas / puxador Queen /  
acabamento lacado



272

Bancada integrada

Pedra Natural Carrara  
com pia dupla



308

Espelho enquadrado

Luxor prata





◀ Peça de mobiliário  
*1 gaveta / puxador Queen /  
acabamento lacado*  
  
Espelho enquadrado  
*Luxor ouro*

Detalhe  
*Puxador 1*



Detalhe  
*Puxador 2*





◀ Peça de mobiliário  
*Laca Blanco*



◀ Peça de mobiliário  
*Laca Océano*



◀ Peça de mobiliário  
*Laca Negro*



◀ Peça de mobiliário  
*Laca Burdeos*

Peça de mobiliário ▶  
4 gavetas / puxador Queen /  
acabamento lacado

Espelho enquadrado  
*Luxor ouro*



QUEEN



QUEEN

# Alma by CÍRCULO<sup>®</sup> CUADRADO

A essência da matéria-prima.  
Respeite e mime o produto.









◀ Móvel

*Banco 2 gavetas / puxador Push / acabamento em carvalho maciço na frente e lacado nas laterais*

 146

Plano de trabalho

*parede plana em carvalho maciço*

 287

Espelho

*Round Liso, estrutura de metal*

 300

Banheiro

*Leo Solid Surface*

 338



▲ Auxiliar

*Toalheiro Lean de carvalho maciço*

 337

Lavatório ►  
Solid Surface Eliptic,  
superfino



Teto falso mitra em  
finalizado respeitar o  
natureza de madeira  
maciça carvalho





- ▲ Bancada suspensa de carvalho maciço sob medida



▲ Auxiliares

*Banco de estrutura de metal com tampo de carvalho maciço*



335



Lavatório  
*Toten Solid Surface*



Bancada  
*Plana Solid Surface  
branco mate*



Móvel  
*2 gavetas / puxador Push / lado Branco  
fosco fino e frente em carvalho maciço  
com acabamento Legno*



Luz decorativa  
*Ledcirc*





▲ Toten de Solid Surface





▲ Detalhe lateral em laca metal extrafine

## CÍRCULO CUADRADO



145

### Móvel ▶

*2 gavetas / puxador Push /  
acabamento lacado*



270

**Bancada integrada**  
*Solid Surface*



287

**Bancada plana**  
*Bancada acabamento lacado*



300

**Espelho liso**  
*A medida*



321

**Luz decorativa**  
*Ledcirc*



336

**Acessórios**  
*Columnas by CirculoCuadrado  
acabamento lacado*













CÍRCULO  
CUADRADO

◀ Auxiliares  
*Set de penteadeiras  
by CirculoCuadrado  
acabamento lacado*

Auxiliares ▶  
*Colunas by  
CirculoCuadrado  
acabamento lacado*



|   |                |
|---|----------------|
|  | NCSS 7500-N    |
|  | NCSS 1002-Y    |
|  | NCSS 5010-G70Y |
|  | NCSS 5010-B10G |
|  | NCSS 4030-Y80R |
|  | NCSS 4010-Y90R |

▲ Cores  
*Cores sugeridos por  
CirculoCuadrado  
acabamento lacado,  
fosco ou brilhante*



ALMA



# 01

## Informação técnica e tarifa

# Atelier

DECOSAN

Bath design





# Olympia

|                                 |     |
|---------------------------------|-----|
| Recursos e equipamentos         | 106 |
| Personalize seus móveis Olympia | 107 |
| Bases de lavatório suspensas    | 108 |
| Formulários suspensos           | 110 |
| Acessórios Atelier              | 148 |



## SISTEMA DECOSPACE

Sistema que fornece o fornecimento de sifão que economiza espaço e válvula click clack em cromo polido. Esta solução evita o colapso da gaveta superior, melhora a capacidade de armazenamento e a estética interior à medida que as estruturas são ocultadas.



## 4D GAVETAS

Gavetas Hettich ou Blum em metal antracite e perfil extrafino de 12 mm com 4 regulagens. Os guias possuem extensão total e sistema de frenagem progressiva.



## SOB MEDIDA

Esta coleção permite a fabricação sob encomenda. No caso de medidas intermediárias de altura e largura, calcule o preço da próxima medida superior.



## ANTRACITE CHEIO DE CORES

Conceito de interior design em que todos os materiais dentro do móveis são projetados em antracite. O gabinete com acabamento é lacado internamente lacado a antracite.



## SISTEMA DURALACK

As cores lacadas contêm aditivos de endurecimento que permitem que o acabamento final seja altamente resistente a fricção e abrasão.



## SISTEMA DECOFIX

Anúncio de sistema de fixação de parede alta segurança com a qual as resistências de carga são maiores que 240 kg.



## DECOBUILD SYSTEM

Móveis feitos com tábuas 19 mm colados com chuteiras obtendo uma estética limpa sem acessórios visíveis e oferece melhor resistência e durabilidade.



## WOOD PROTECT SYSTEM

A madeira da prancha marinha é protegida dos agentes externo com óleos naturais que respeitam a consistência e o natureza da madeira.



## ATELIER SYSTEM

Nos acabamentos de mesa marinho, as peças são selecionadas de forma numerada para respeitar a continuidade do grão ao longo do móvel.

## Configure e personalize seus móveis Olympia

### A Escolha a textura

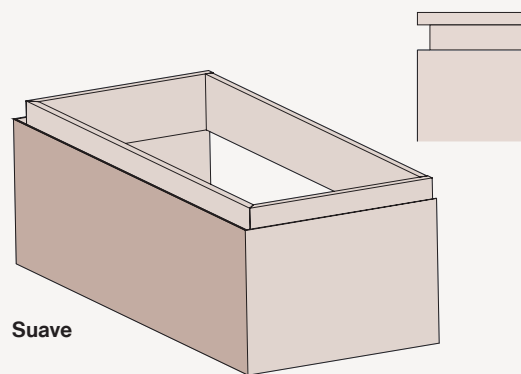
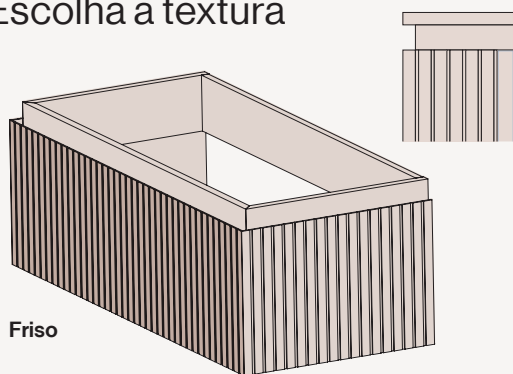

### B Escolha a cor dos móveis

#### Lacado



#### Prancha Madeira Marinha / Folheado de Carvalho e Nogueira

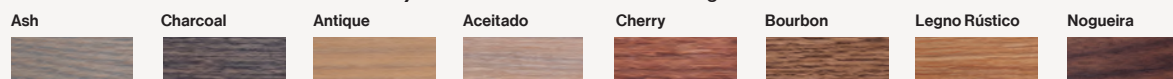

### C Escolha a cor do pescoço

#### Lacado



#### Prancha Madeira Marinha / Folheado de Carvalho e Nogueira

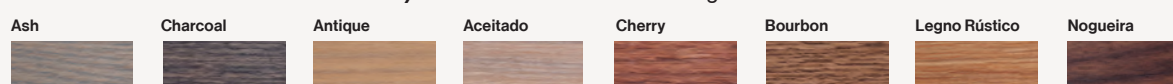

#### Metal



### BASES PARA LAVATÓRIO PENDURADO NA PAREDE

#### 1 GAVETA

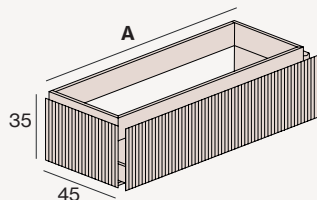

| A (cm) | AFUNDAR | REF        | LACA         |             | PRANCHA MADEIRA MARINHA |             |
|--------|---------|------------|--------------|-------------|-------------------------|-------------|
|        |         |            | FRONT FRIDGE | FRONTA LISO | FRONT FRIDGE            | FRONTA LISO |
| 60     |         | Y101.060.C | -            | -           | -                       | -           |
| 70     |         | Y101.070.C | -            | -           | -                       | -           |
| 80     |         | Y101.080.C | -            | -           | -                       | -           |
| 90     |         | Y101.090.C | -            | -           | -                       | -           |
| 100    |         | Y101.100.I | -            | -           | -                       | -           |
| 100    |         | Y101.100.C | -            | -           | -                       | -           |
| 100    |         | Y101.100.D | -            | -           | -                       | -           |
| 120    |         | Y101.120.I | -            | -           | -                       | -           |
| 120    |         | Y101.120.C | -            | -           | -                       | -           |
| 120    |         | Y101.120.D | -            | -           | -                       | -           |
| 120    |         | Y101.120.X | -            | -           | -                       | -           |
| 140    |         | Y101.140.I | -            | -           | -                       | -           |
| 140    |         | Y101.140.C | -            | -           | -                       | -           |
| 140    |         | Y101.140.D | -            | -           | -                       | -           |
| 140    |         | Y101.140.X | -            | -           | -                       | -           |

#### 2 GAVETAS SIMÉTRICAS

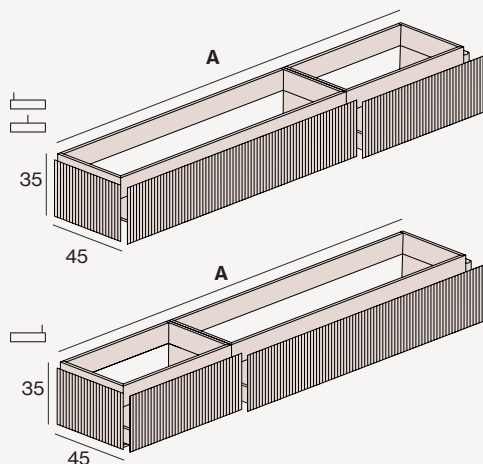

|     |  |            |   |   |   |   |
|-----|--|------------|---|---|---|---|
| 120 |  | Y102.120.I | - | - | - | - |
| 120 |  | Y102.120.C | - | - | - | - |
| 120 |  | Y102.120.D | - | - | - | - |
| 140 |  | Y102.140.I | - | - | - | - |
| 140 |  | Y102.140.C | - | - | - | - |
| 140 |  | Y102.140.D | - | - | - | - |
| 160 |  | Y102.160.I | - | - | - | - |
| 160 |  | Y102.160.C | - | - | - | - |
| 160 |  | Y102.160.D | - | - | - | - |
| 180 |  | Y102.180.I | - | - | - | - |
| 180 |  | Y102.180.C | - | - | - | - |
| 180 |  | Y102.180.D | - | - | - | - |
| 200 |  | Y102.200.I | - | - | - | - |
| 200 |  | Y102.200.C | - | - | - | - |
| 200 |  | Y102.200.D | - | - | - | - |

#### 2 GAVETAS ASSIMÉTRICAS

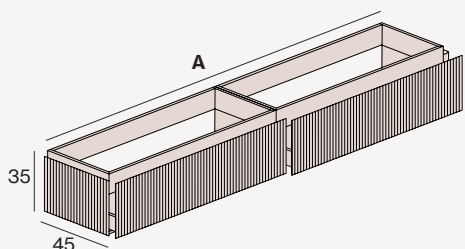

|     |  |            |   |   |   |   |
|-----|--|------------|---|---|---|---|
| 120 |  | Y103.120.I | - | - | - | - |
| 120 |  | Y103.120.D | - | - | - | - |
| 120 |  | Y103.120.X | - | - | - | - |
| 140 |  | Y103.140.I | - | - | - | - |
| 140 |  | Y103.140.D | - | - | - | - |
| 140 |  | Y103.140.X | - | - | - | - |
| 160 |  | Y103.160.I | - | - | - | - |
| 160 |  | Y103.160.D | - | - | - | - |
| 160 |  | Y103.160.X | - | - | - | - |
| 180 |  | Y103.180.I | - | - | - | - |
| 180 |  | Y103.180.D | - | - | - | - |
| 180 |  | Y103.180.X | - | - | - | - |
| 200 |  | Y103.200.I | - | - | - | - |
| 200 |  | Y103.200.D | - | - | - | - |
| 200 |  | Y103.200.X | - | - | - | - |



- As composições assimétricas têm a seguinte modulação: 120 (80 + 40), 140 (80 + 60), 160 (100 + 60), 180 (120 + 60), 200 (120 + 80). Outras configurações disponíveis.
- Móveis especiais: para medidas intermediárias de largura e / ou altura, leve a preço do próximo tamanho superior. Fundo especial disponível de 39 a 45 cm. Consulte outros fundos.
- O guarda-roupa de 35 nós não possui sistema Decospace. Se a instalação permitir, ele pode ser encomendado sem nenhum custo extra.

- C Lavatório centrado
- D Lavatório direita
- I Lavatório esquerda
- X Lavatório duplo

### BASES PARA LAVATÓRIO PENDURADO NA PAREDE

#### TRONCO

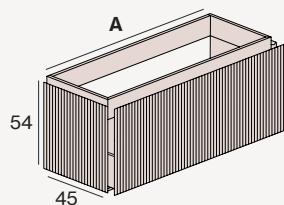

(1)

| A (cm) | AFUNDAR | REF        | LACA         |             | PRANCHA MADEIRA MARINHA |             |
|--------|---------|------------|--------------|-------------|-------------------------|-------------|
|        |         |            | FRONT FRIDGE | FRONTA LISO | FRONT FRIDGE            | FRONTA LISO |
| 60     |         | Y202.060.C | -            | -           | -                       | -           |
| 70     |         | Y202.070.C | -            | -           | -                       | -           |
| 80     |         | Y202.080.C | -            | -           | -                       | -           |
| 90     |         | Y202.090.C | -            | -           | -                       | -           |
| 100    |         | Y202.100.I | -            | -           | -                       | -           |
| 100    |         | Y202.100.C | -            | -           | -                       | -           |
| 100    |         | Y202.100.D | -            | -           | -                       | -           |
| 120    |         | Y202.120.I | -            | -           | -                       | -           |
| 120    |         | Y202.120.C | -            | -           | -                       | -           |
| 120    |         | Y202.120.D | -            | -           | -                       | -           |
| 120    |         | Y202.120.X | -            | -           | -                       | -           |
| 140    |         | Y202.140.I | -            | -           | -                       | -           |
| 140    |         | Y202.140.C | -            | -           | -                       | -           |
| 140    |         | Y202.140.D | -            | -           | -                       | -           |
| 140    |         | Y202.140.X | -            | -           | -                       | -           |

#### 2 TRONCOS SIMÉTRICOS

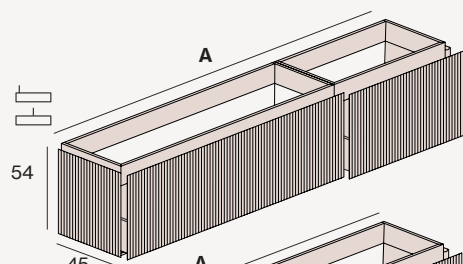

(1)

|     |  |            |   |   |   |   |
|-----|--|------------|---|---|---|---|
| 120 |  | Y210.120.I | - | - | - | - |
| 120 |  | Y210.120.C | - | - | - | - |
| 120 |  | Y210.120.D | - | - | - | - |
| 140 |  | Y210.140.I | - | - | - | - |
| 140 |  | Y210.140.C | - | - | - | - |
| 140 |  | Y210.140.D | - | - | - | - |
| 160 |  | Y210.160.I | - | - | - | - |
| 160 |  | Y210.160.C | - | - | - | - |
| 160 |  | Y210.160.D | - | - | - | - |
| 180 |  | Y210.180.I | - | - | - | - |
| 180 |  | Y210.180.C | - | - | - | - |
| 180 |  | Y210.180.D | - | - | - | - |
| 200 |  | Y210.200.I | - | - | - | - |
| 200 |  | Y210.200.C | - | - | - | - |
| 200 |  | Y210.200.D | - | - | - | - |

#### 2 TRONCOS SIMÉTRICOS

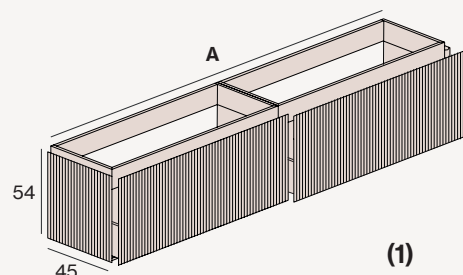

(1)

|     |  |            |   |   |   |   |
|-----|--|------------|---|---|---|---|
| 120 |  | Y211.120.I | - | - | - | - |
| 120 |  | Y211.120.D | - | - | - | - |
| 120 |  | Y211.120.X | - | - | - | - |
| 140 |  | Y211.140.I | - | - | - | - |
| 140 |  | Y211.140.D | - | - | - | - |
| 140 |  | Y211.140.X | - | - | - | - |
| 160 |  | Y211.160.I | - | - | - | - |
| 160 |  | Y211.160.D | - | - | - | - |
| 160 |  | Y211.160.X | - | - | - | - |
| 180 |  | Y211.180.I | - | - | - | - |
| 180 |  | Y211.180.D | - | - | - | - |
| 180 |  | Y211.180.X | - | - | - | - |
| 200 |  | Y211.200.I | - | - | - | - |
| 200 |  | Y211.200.D | - | - | - | - |
| 200 |  | Y211.200.X | - | - | - | - |

#### Acessórios

##### & complementa

COMPLEMENTA  
SEUS MÓVEIS  
Organizadores, toalheiros, ...  
página 148

#### (1) GAVETA INTERNA

A gaveta interna  
pode ser inserido  
as composições  
as composições  
com o porta-malas.

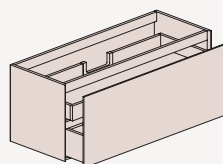

| A (cm) | REF       | PVP |
|--------|-----------|-----|
| 40     | A220.040  | -   |
| 60     | A220.060  | -   |
| 70     | A220.070  | -   |
| 80     | A220.080  | -   |
| 90     | A220.090  | -   |
| 100    | A220.100  | -   |
| 120    | A220.120  | -   |
| 120X   | A220.120X | -   |
| 140    | A220.140  | -   |
| 140X   | A220.140X | -   |

## MÓDULOS SUSPENSOS

## 1 GAVETA / BANCO

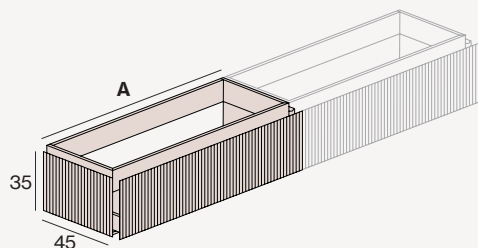

| A (cm) | REF        | LACA         |             | PRANCHA MADEIRA MARINHA |             |
|--------|------------|--------------|-------------|-------------------------|-------------|
|        |            | FRONT FRIDGE | FRONTA LISO | FRONT FRIDGE            | FRONTA LISO |
| 30     | Y101.030.M | -            | -           | -                       | -           |
| 40     | Y101.040.M | -            | -           | -                       | -           |
| 60     | Y101.060.M | -            | -           | -                       | -           |
| 70     | Y101.070.M | -            | -           | -                       | -           |
| 80     | Y101.080.M | -            | -           | -                       | -           |
| 90     | Y101.090.M | -            | -           | -                       | -           |
| 100    | Y101.100.M | -            | -           | -                       | -           |
| 120    | Y101.120.M | -            | -           | -                       | -           |
| 140    | Y101.140.M | -            | -           | -                       | -           |

## 2 GAVETAS / BANCO

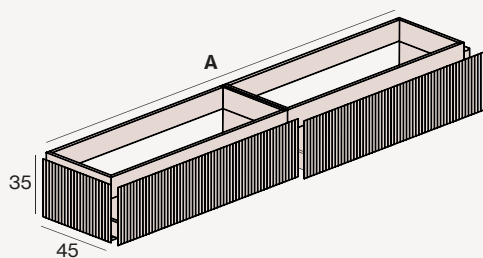

|     |            |   |   |   |   |
|-----|------------|---|---|---|---|
| 120 | Y103.120.M | - | - | - | - |
| 140 | Y103.140.M | - | - | - | - |
| 160 | Y103.160.M | - | - | - | - |
| 180 | Y103.180.M | - | - | - | - |
| 200 | Y103.200.M | - | - | - | - |



- Você pode criar seus próprios móveis personalizados adicionando os módulos à direita e / ou à esquerda da base do lavatório selecionada.
- Especifique sua localização.

## MÓDULOS SUSPENSOS

## 1 TRONCO

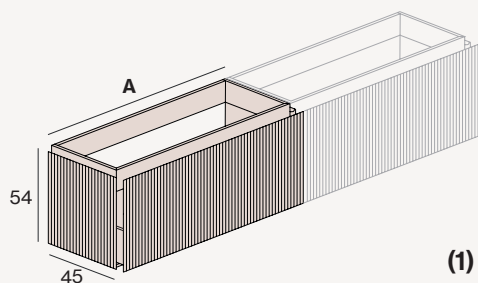

| A (cm) | REF        | LACA         |             | PRANCHA MADEIRA MARINHA |             |
|--------|------------|--------------|-------------|-------------------------|-------------|
|        |            | FRONT FRIDGE | FRONTA LISO | FRONT FRIDGE            | FRONTA LISO |
| 30     | Y202.030.M | -            | -           | -                       | -           |
| 40     | Y202.040.M | -            | -           | -                       | -           |
| 60     | Y202.060.M | -            | -           | -                       | -           |
| 70     | Y202.070.M | -            | -           | -                       | -           |
| 80     | Y202.080.M | -            | -           | -                       | -           |
| 90     | Y202.090.M | -            | -           | -                       | -           |
| 100    | Y202.100.M | -            | -           | -                       | -           |
| 120    | Y202.120.M | -            | -           | -                       | -           |
| 140    | Y202.140.M | -            | -           | -                       | -           |

## Acessórios

**& complementa**

COMPLEMENTA  
SEUS MÓVEIS  
Organizadores, toalheiros, ...  
página 148

**(1) GAVETA INTERNA**

A gaveta interna  
pode ser inserido  
as composições  
com o porta-malas.

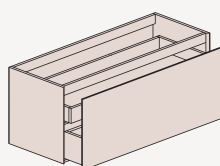

| A (cm) | REF      | PVP |
|--------|----------|-----|
| 40     | A221.040 | -   |
| 60     | A221.060 | -   |
| 70     | A221.070 | -   |
| 80     | A221.080 | -   |
| 90     | A221.090 | -   |
| 100    | A221.100 | -   |
| 120    | A221.120 | -   |
| 140    | A221.140 | -   |





# Diamond

|                                 |     |
|---------------------------------|-----|
| Recursos e equipamentos         | 114 |
| Personalize seus móveis Diamond | 115 |
| Bases de lavatório suspensas    | 116 |
| Módulos suspensos               | 120 |
| Acessórios Atelier              | 148 |



## DECOSPACE SYSTEM

Sistema que fornece o fornecimento de um sifão que economiza espaço e uma válvula click clack em cromo polido. Esta solução evita o colapso da gaveta superior melhorando a capacidade de armazenamento e a estética interna, pois as estruturas estão ocultas.



## 4D GAVETAS

Gavetas Hettich ou Blum em metal antracite e perfil extrafino de 12 mm com 4 regulagens. Os guias possuem extensão total e sistema de frenagem progressiva.



## SOB MEDIDA

Esta coleção permite a fabricação sob medida. No caso de medidas intermediárias de altura e largura, calcule o preço da próxima medida superior.



## ANTRACITE FULLCOLOR

Conceito de design de interiores onde todos os materiais do interior do móvel são desenhados em antracite. O gabinete com acabamento lacado é lacado internamente em antracite.



## DURALACK SYSTEM

As cores lacadas contêm aditivos de endurecimento que permitem que o acabamento final seja altamente resistente a fricção e abrasão.



## PUSH AND SLOW

As gavetas com sistema de abertura Push sem puxadores possuem um sistema de sincronização que permite a sua abertura pressionando em qualquer parte da frente. Ao mesmo tempo, o fechamento é progressivo e silencioso.



## DECOFIX SYSTEM

Sistema de fixação de parede de alta segurança com o qual as resistências de carga são mais de 240 kg.



## DECOBUILD SYSTEM

Móveis feitos com placas de 19 mm colados com cutelos obtendo uma estética limpa sem encaixes visíveis e oferecendo maior resistência e durabilidade.



## WOOD PROTECT SYSTEM

As madeiras da mesa marinha São protegidas de agentes externos com óleos naturais que respeitam a textura e natureza da madeira.



## ATELIER SYSTEM

Nos acabamentos marítimos, as peças são selecionadas de forma numerada para respeitar a continuidade do grão em todo o gabinete.

## Configure e personalize seus móveis Diamond

### A Escolha o puxador

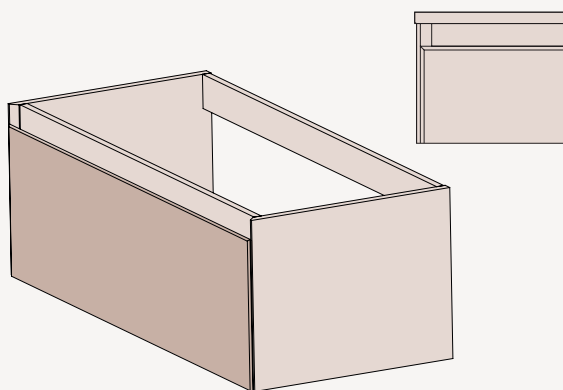

Diamond

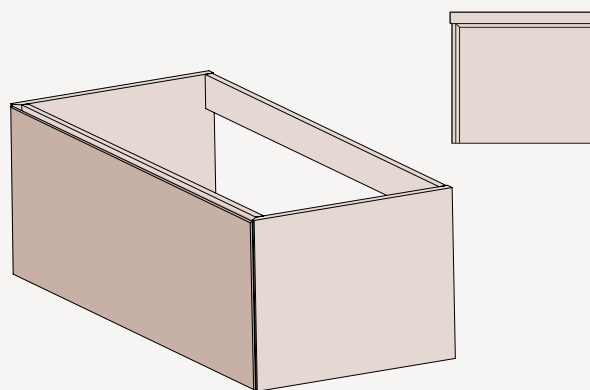

Push

### B Escolha a cor

#### Lacado



#### Prancha Madeira Marinha / Folheado de Carvalho e Nogueira

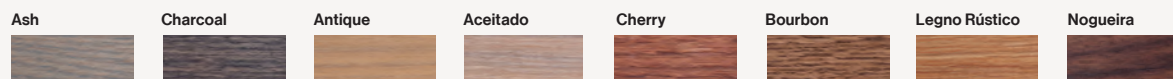

## BASES PARA LAVATÓRIO PENDURADO NA PAREDE

## 1 GAVETA

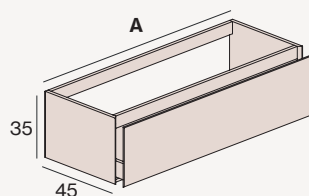

## 2 GAVETAS ASSIMÉTRICAS

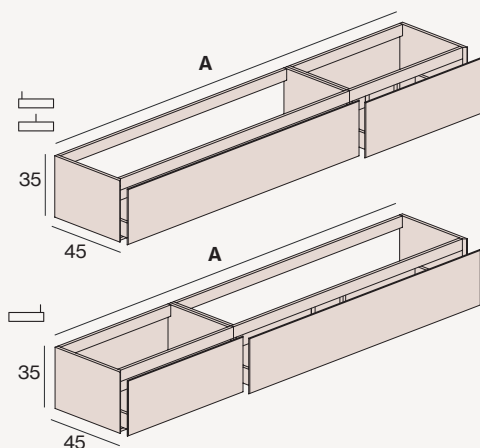

## 2 GAVETAS ASSIMÉTRICAS

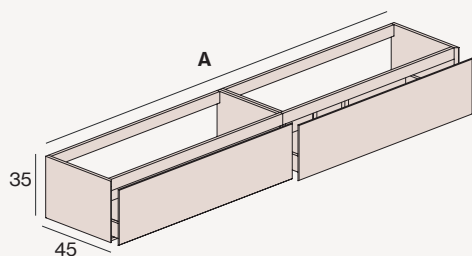

- As composições assimétricas têm a seguinte modulação: 120 (80 + 40), 140 (80 + 60), 160 (100 + 60), 180 (120 + 60), 200 (120 + 80). Outras configurações disponíveis.
- Móveis especiais: para medidas intermediárias de largura e / ou altura, tome o preço da medida imediatamente superior.
- O guarda-roupa de 35 nós não possui sistema Decospace. Se a instalação permitir, ele pode ser encomendado sem nenhum custo extra.

| A (cm) | AFUNDAR | REF        | LACA            |              | PRANCHA MADEIRA MARINHA |              |
|--------|---------|------------|-----------------|--------------|-------------------------|--------------|
|        |         |            | PUXADOR DIAMOND | PUXADOR PUSH | PUXADOR DIAMOND         | PUXADOR PUSH |
| 60     |         | D101.060.C | -               | -            | -                       | -            |
| 70     |         | D101.070.C | -               | -            | -                       | -            |
| 80     |         | D101.080.C | -               | -            | -                       | -            |
| 90     |         | D101.090.C | -               | -            | -                       | -            |
| 100    |         | D101.100.I | -               | -            | -                       | -            |
| 100    |         | D101.100.C | -               | -            | -                       | -            |
| 100    |         | D101.100.D | -               | -            | -                       | -            |
| 120    |         | D101.120.I | -               | -            | -                       | -            |
| 120    |         | D101.120.C | -               | -            | -                       | -            |
| 120    |         | D101.120.D | -               | -            | -                       | -            |
| 120    |         | D101.120.X | -               | -            | -                       | -            |
| 140    |         | D101.140.I | -               | -            | -                       | -            |
| 140    |         | D101.140.C | -               | -            | -                       | -            |
| 140    |         | D101.140.D | -               | -            | -                       | -            |
| 140    |         | D101.140.X | -               | -            | -                       | -            |
| 120    |         | D102.120.I | -               | -            | -                       | -            |
| 120    |         | D102.120.C | -               | -            | -                       | -            |
| 120    |         | D102.120.D | -               | -            | -                       | -            |
| 140    |         | D102.140.I | -               | -            | -                       | -            |
| 140    |         | D102.140.C | -               | -            | -                       | -            |
| 140    |         | D102.140.D | -               | -            | -                       | -            |
| 160    |         | D102.160.I | -               | -            | -                       | -            |
| 160    |         | D102.160.C | -               | -            | -                       | -            |
| 160    |         | D102.160.D | -               | -            | -                       | -            |
| 180    |         | D102.180.I | -               | -            | -                       | -            |
| 180    |         | D102.180.C | -               | -            | -                       | -            |
| 180    |         | D102.180.D | -               | -            | -                       | -            |
| 200    |         | D102.200.I | -               | -            | -                       | -            |
| 200    |         | D102.200.C | -               | -            | -                       | -            |
| 200    |         | D102.200.D | -               | -            | -                       | -            |
| 120    |         | D103.120.I | -               | -            | -                       | -            |
| 120    |         | D103.120.D | -               | -            | -                       | -            |
| 120    |         | D103.120.X | -               | -            | -                       | -            |
| 140    |         | D103.140.I | -               | -            | -                       | -            |
| 140    |         | D103.140.D | -               | -            | -                       | -            |
| 140    |         | D103.140.X | -               | -            | -                       | -            |
| 160    |         | D103.160.I | -               | -            | -                       | -            |
| 160    |         | D103.160.D | -               | -            | -                       | -            |
| 160    |         | D103.160.X | -               | -            | -                       | -            |
| 180    |         | D103.180.I | -               | -            | -                       | -            |
| 180    |         | D103.180.D | -               | -            | -                       | -            |
| 180    |         | D103.180.X | -               | -            | -                       | -            |
| 200    |         | D103.200.I | -               | -            | -                       | -            |
| 200    |         | D103.200.D | -               | -            | -                       | -            |
| 200    |         | D103.200.X | -               | -            | -                       | -            |

- C Lavatório centrado
- D Lavatório direita
- I Lavatório esquerda
- X Lavatório duplo

## BASES PARA LAVATÓRIO PENDURADO NA PAREDE

## 2 GAVETAS

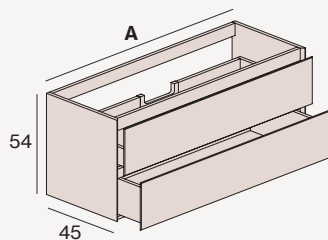

| A (cm) | AFUNDAR | REF        | LACA            |              | PRANCHA MADEIRA MARINHA |              |
|--------|---------|------------|-----------------|--------------|-------------------------|--------------|
|        |         |            | PUXADOR DIAMOND | PUXADOR PUSH | PUXADOR DIAMOND         | PUXADOR PUSH |
| 60     |         | D201.060.C | -               | -            | -                       | -            |
| 70     |         | D201.070.C | -               | -            | -                       | -            |
| 80     |         | D201.080.C | -               | -            | -                       | -            |
| 90     |         | D201.090.C | -               | -            | -                       | -            |
| 100    |         | D201.100.I | -               | -            | -                       | -            |
| 100    |         | D201.100.C | -               | -            | -                       | -            |
| 100    |         | D201.100.D | -               | -            | -                       | -            |
| 120    |         | D201.120.I | -               | -            | -                       | -            |
| 120    |         | D201.120.C | -               | -            | -                       | -            |
| 120    |         | D201.120.D | -               | -            | -                       | -            |
| 120    |         | D201.120.X | -               | -            | -                       | -            |
| 140    |         | D201.140.I | -               | -            | -                       | -            |
| 140    |         | D201.140.C | -               | -            | -                       | -            |
| 140    |         | D201.140.D | -               | -            | -                       | -            |
| 140    |         | D201.140.X | -               | -            | -                       | -            |

## 1 TRONCO

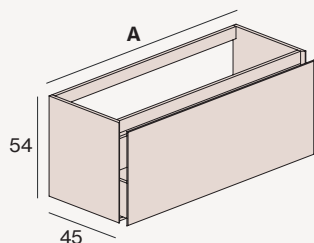

(1)

|     |  |            |   |    |   |    |
|-----|--|------------|---|----|---|----|
| 60  |  | D202.060.C | - | -  | - | -  |
| 70  |  | D202.070.C | - | -  | - | -  |
| 80  |  | D202.080.C | - | -  | - | -  |
| 90  |  | D202.090.C | - | -  | - | -  |
| 100 |  | D202.100.I | - | -  | - | -  |
| 100 |  | D202.100.C | - | -  | - | -  |
| 100 |  | D202.100.D | - | -  | - | -  |
| 120 |  | D202.120.I | - | -  | - | -  |
| 120 |  | D202.120.C | - | -  | - | -  |
| 120 |  | D202.120.D | - | -  | - | -  |
| 120 |  | D202.120.X | - | -  | - | -  |
| 140 |  | D202.140.I | - | ND | - | ND |
| 140 |  | D202.140.C | - | ND | - | ND |
| 140 |  | D202.140.D | - | ND | - | ND |
| 140 |  | D202.140.X | - | ND | - | ND |

## 1 GAVETA + DECORATIVA

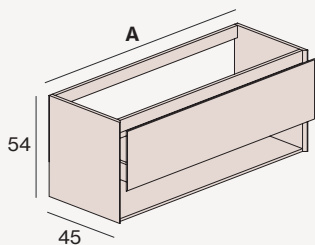

|     |  |            |   |   |   |   |
|-----|--|------------|---|---|---|---|
| 60  |  | D203.060.C | - | - | - | - |
| 70  |  | D203.070.C | - | - | - | - |
| 80  |  | D203.080.C | - | - | - | - |
| 90  |  | D203.090.C | - | - | - | - |
| 100 |  | D203.100.I | - | - | - | - |
| 100 |  | D203.100.C | - | - | - | - |
| 100 |  | D203.100.D | - | - | - | - |
| 120 |  | D203.120.I | - | - | - | - |
| 120 |  | D203.120.C | - | - | - | - |
| 120 |  | D203.120.D | - | - | - | - |
| 120 |  | D203.120.X | - | - | - | - |
| 140 |  | D203.140.I | - | - | - | - |
| 140 |  | D203.140.C | - | - | - | - |
| 140 |  | D203.140.D | - | - | - | - |
| 140 |  | D203.140.X | - | - | - | - |

Acessórios

**& complementa**  
COMPLEMENTA  
SEUS MÓVEIS  
Organizadores, toalheiros, ...  
página 148

## (1) GAVETA INTERNA

A gaveta interna  
pode ser inserido  
as composições  
com o porta-malas.

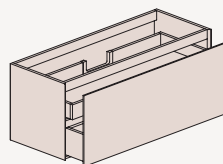

| A (cm) | REF       | PVP |
|--------|-----------|-----|
| 40     | A220.040  | -   |
| 60     | A220.060  | -   |
| 70     | A220.070  | -   |
| 80     | A220.080  | -   |
| 90     | A220.090  | -   |
| 100    | A220.100  | -   |
| 120    | A220.120  | -   |
| 120X   | A220.120X | -   |
| 140    | A220.140  | -   |
| 140X   | A220.140X | -   |

### BASES PARA LAVATÓRIO PENDURADO NA PAREDE

#### TRONCO + 2 GAVETAS ASSIMÉTRICAS

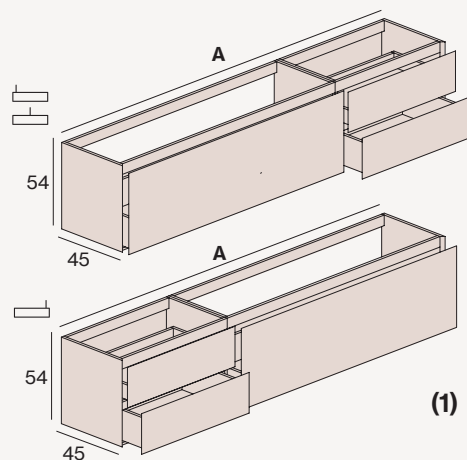

#### TRONCO + 2 GAVETAS

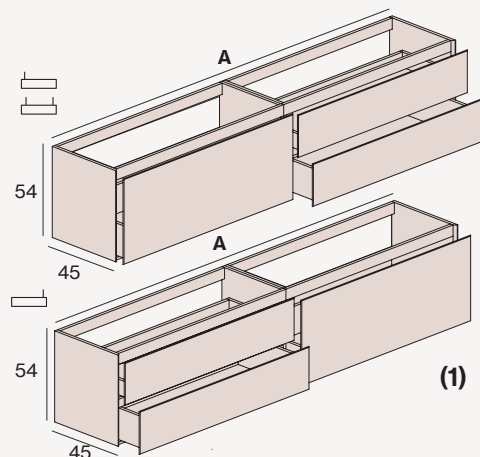

#### 4 GAVETAS ASSIMÉTRICAS

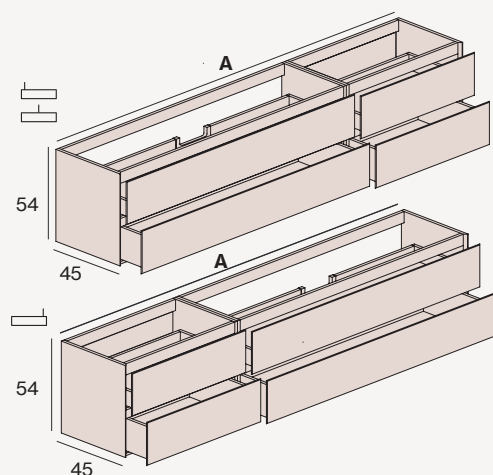

| A (cm) | AFUNDAR | REF        | LACA            |              | PRANCHA MADEIRA MARINHA |              |
|--------|---------|------------|-----------------|--------------|-------------------------|--------------|
|        |         |            | PUXADOR DIAMOND | PUXADOR PUSH | PUXADOR DIAMOND         | PUXADOR PUSH |
| 120    |         | D205.120.I | -               | -            | -                       | -            |
| 120    |         | D205.120.C | -               | -            | -                       | -            |
| 120    |         | D205.120.D | -               | -            | -                       | -            |
| 140    |         | D205.140.I | -               | -            | -                       | -            |
| 140    |         | D205.140.C | -               | -            | -                       | -            |
| 140    |         | D205.140.D | -               | -            | -                       | -            |
| 160    |         | D205.160.I | -               | -            | -                       | -            |
| 160    |         | D205.160.C | -               | -            | -                       | -            |
| 160    |         | D205.160.D | -               | -            | -                       | -            |
| 180    |         | D205.180.I | -               | -            | -                       | -            |
| 180    |         | D205.180.C | -               | -            | -                       | -            |
| 180    |         | D205.180.D | -               | -            | -                       | -            |
| 200    |         | D205.200.I | -               | -            | -                       | -            |
| 200    |         | D205.200.C | -               | -            | -                       | -            |
| 200    |         | D205.200.D | -               | -            | -                       | -            |
| <hr/>  |         |            |                 |              |                         |              |
| 120    |         | D206.120.I | -               | -            | -                       | -            |
| 120    |         | D206.120.D | -               | -            | -                       | -            |
| 120    |         | D206.120.X | -               | -            | -                       | -            |
| 140    |         | D206.140.I | -               | -            | -                       | -            |
| 140    |         | D206.140.D | -               | -            | -                       | -            |
| 140    |         | D206.140.X | -               | -            | -                       | -            |
| 160    |         | D206.160.I | -               | -            | -                       | -            |
| 160    |         | D206.160.D | -               | -            | -                       | -            |
| 160    |         | D206.160.X | -               | -            | -                       | -            |
| 180    |         | D206.180.I | -               | -            | -                       | -            |
| 180    |         | D206.180.D | -               | -            | -                       | -            |
| 180    |         | D206.180.X | -               | -            | -                       | -            |
| 200    |         | D206.200.I | -               | -            | -                       | -            |
| 200    |         | D206.200.D | -               | -            | -                       | -            |
| 200    |         | D206.200.X | -               | -            | -                       | -            |
| <hr/>  |         |            |                 |              |                         |              |
| 120    |         | D208.120.I | -               | -            | -                       | -            |
| 120    |         | D208.120.C | -               | -            | -                       | -            |
| 120    |         | D208.120.D | -               | -            | -                       | -            |
| 140    |         | D208.140.I | -               | -            | -                       | -            |
| 140    |         | D208.140.C | -               | -            | -                       | -            |
| 140    |         | D208.140.D | -               | -            | -                       | -            |
| 160    |         | D208.160.I | -               | -            | -                       | -            |
| 160    |         | D208.160.C | -               | -            | -                       | -            |
| 160    |         | D208.160.D | -               | -            | -                       | -            |
| 180    |         | D208.180.I | -               | -            | -                       | -            |
| 180    |         | D208.180.C | -               | -            | -                       | -            |
| 180    |         | D208.180.D | -               | -            | -                       | -            |
| 200    |         | D208.200.I | -               | -            | -                       | -            |
| 200    |         | D208.200.C | -               | -            | -                       | -            |
| 200    |         | D208.200.D | -               | -            | -                       | -            |



- As composições assimétricas têm a seguinte modulação: 120 (80 + 40), 140 (80 + 60), 160 (100 + 60), 180 (120 + 60), 200 (120 + 80). Outras configurações disponíveis.
- Móveis especiais: para medidas intermediárias de largura e / ou altura, tome o preço da medida imediatamente superior.
- O guarda-roupa de 35 néis não possui sistema Decospace. Se a instalação permitir, ele pode ser encomendado sem nenhum custo extra.

- C Lavatório centrado
- D Lavatório direita
- I Lavatório esquerda
- X Lavatório duplo

### BASES PARA LAVATÓRIO PENDURADO NA PAREDE

#### 4 GAVETAS SIMÉTRICAS

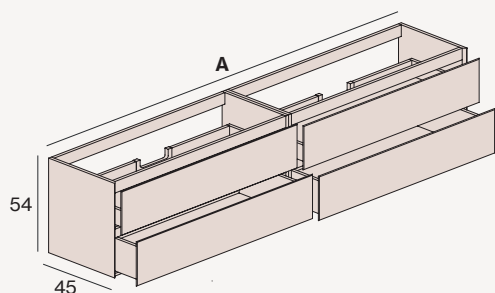

#### 2 TRONCOS SIMÉTRICOS

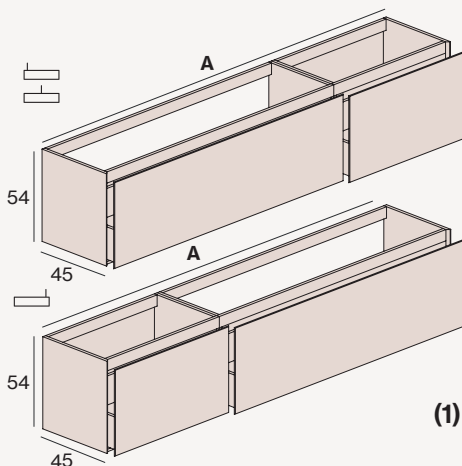

#### 2 TRONCOS SIMÉTRICOS

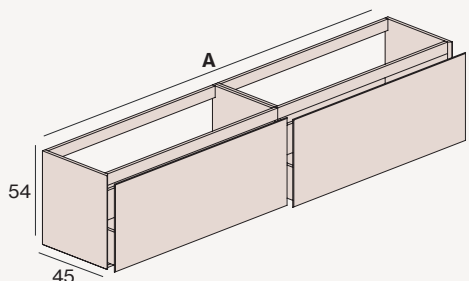

Acessórios

| A (cm) | AFUNDAR | REF        | LACA            |              | PRANCHA MADEIRA MARINHA |              |
|--------|---------|------------|-----------------|--------------|-------------------------|--------------|
|        |         |            | PUXADOR DIAMOND | PUXADOR PUSH | PUXADOR DIAMOND         | PUXADOR PUSH |
| 120    |         | D209.120.I | -               | -            | -                       | -            |
| 120    |         | D209.120.D | -               | -            | -                       | -            |
| 120    |         | D209.120.X | -               | -            | -                       | -            |
| 140    |         | D209.140.I | -               | -            | -                       | -            |
| 140    |         | D209.140.D | -               | -            | -                       | -            |
| 140    |         | D209.140.X | -               | -            | -                       | -            |
| 160    |         | D209.160.I | -               | -            | -                       | -            |
| 160    |         | D209.160.D | -               | -            | -                       | -            |
| 160    |         | D209.160.X | -               | -            | -                       | -            |
| 180    |         | D209.180.I | -               | -            | -                       | -            |
| 180    |         | D209.180.D | -               | -            | -                       | -            |
| 180    |         | D209.180.X | -               | -            | -                       | -            |
| 200    |         | D209.200.I | -               | -            | -                       | -            |
| 200    |         | D209.200.D | -               | -            | -                       | -            |
| 200    |         | D209.200.X | -               | -            | -                       | -            |
|        |         |            |                 |              |                         |              |
| 120    |         | D210.120.I | -               | -            | -                       | -            |
| 120    |         | D210.120.C | -               | -            | -                       | -            |
| 120    |         | D210.120.D | -               | -            | -                       | -            |
| 140    |         | D210.140.I | -               | -            | -                       | -            |
| 140    |         | D210.140.C | -               | -            | -                       | -            |
| 140    |         | D210.140.D | -               | -            | -                       | -            |
| 160    |         | D210.160.I | -               | -            | -                       | -            |
| 160    |         | D210.160.C | -               | -            | -                       | -            |
| 160    |         | D210.160.D | -               | -            | -                       | -            |
| 180    |         | D210.180.I | -               | -            | -                       | -            |
| 180    |         | D210.180.C | -               | -            | -                       | -            |
| 180    |         | D210.180.D | -               | -            | -                       | -            |
| 200    |         | D210.200.I | -               | -            | -                       | -            |
| 200    |         | D210.200.C | -               | -            | -                       | -            |
| 200    |         | D210.200.D | -               | -            | -                       | -            |
|        |         |            |                 |              |                         |              |
| 120    |         | D211.120.I | -               | -            | -                       | -            |
| 120    |         | D211.120.D | -               | -            | -                       | -            |
| 120    |         | D211.120.X | -               | -            | -                       | -            |
| 140    |         | D211.140.I | -               | -            | -                       | -            |
| 140    |         | D211.140.D | -               | -            | -                       | -            |
| 140    |         | D211.140.X | -               | -            | -                       | -            |
| 160    |         | D211.160.I | -               | -            | -                       | -            |
| 160    |         | D211.160.D | -               | -            | -                       | -            |
| 160    |         | D211.160.X | -               | -            | -                       | -            |
| 180    |         | D211.180.I | -               | -            | -                       | -            |
| 180    |         | D211.180.D | -               | -            | -                       | -            |
| 180    |         | D211.180.X | -               | -            | -                       | -            |
| 200    |         | D211.200.I | -               | -            | -                       | -            |
| 200    |         | D211.200.D | -               | -            | -                       | -            |
| 200    |         | D211.200.X | -               | -            | -                       | -            |

#### & complementa

COMPLEMENTA SEUS MÓVEIS  
Organizadores, toalheiros, ...  
página 148

#### (1) GAVETA INTERNA

A gaveta interna pode ser inserido as composições com o porta-malas.

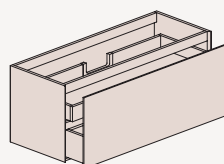

| A (cm) | REF       | PVP |
|--------|-----------|-----|
| 40     | A220.040  | -   |
| 60     | A220.060  | -   |
| 70     | A220.070  | -   |
| 80     | A220.080  | -   |
| 90     | A220.090  | -   |
| 100    | A220.100  | -   |
| 120    | A220.120  | -   |
| 120X   | A220.120X | -   |
| 140    | A220.140  | -   |
| 140X   | A220.140X | -   |

### MÓDULOS SUSPENSOS

#### 1 GAVETA / BANCO

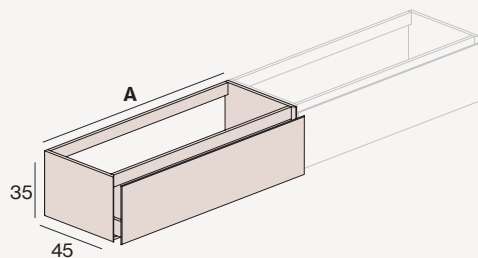

#### 2 GAVETAS / BANCO

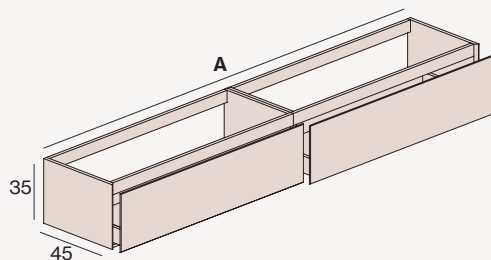

#### DECORATIVO

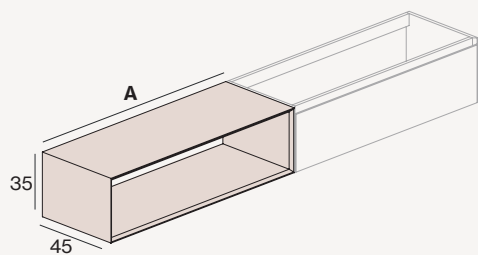

| A (cm) | REF        | LACA            |              | PRANCHA MADEIRA MARINHA |              |
|--------|------------|-----------------|--------------|-------------------------|--------------|
|        |            | PUXADOR DIAMOND | PUXADOR PUSH | PUXADOR DIAMOND         | PUXADOR PUSH |
| 30     | D101.030.M | -               | -            | -                       | -            |
| 40     | D101.040.M | -               | -            | -                       | -            |
| 60     | D101.060.M | -               | -            | -                       | -            |
| 70     | D101.070.M | -               | -            | -                       | -            |
| 80     | D101.080.M | -               | -            | -                       | -            |
| 90     | D101.090.M | -               | -            | -                       | -            |
| 100    | D101.100.M | -               | -            | -                       | -            |
| 120    | D101.120.M | -               | -            | -                       | -            |
| 140    | D101.140.M | -               | -            | -                       | -            |

|     |            |   |   |   |   |
|-----|------------|---|---|---|---|
| 120 | D103.120.M | - | - | - | - |
| 140 | D103.140.M | - | - | - | - |
| 160 | D103.160.M | - | - | - | - |
| 180 | D103.180.M | - | - | - | - |
| 200 | D103.200.M | - | - | - | - |

|    |            |   |   |   |   |
|----|------------|---|---|---|---|
| 30 | D104.030.M | - | - | - | - |
| 40 | D104.040.M | - | - | - | - |
| 60 | D104.060.M | - | - | - | - |
| 70 | D104.070.M | - | - | - | - |
| 80 | D104.080.M | - | - | - | - |



- Você pode criar seus próprios móveis personalizados adicionando os módulos à direita e / ou à esquerda da base do lavatório selecionada.
- Especifique sua localização.



### MÓDULOS SUSPENSOS

#### 1 TRONCO

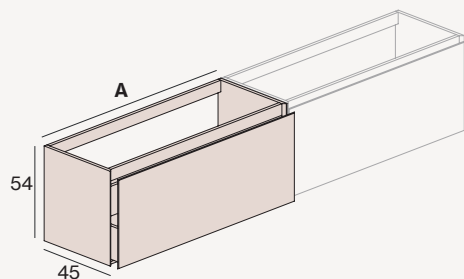

(1)

#### 1 GAVETA + DECORATIVA

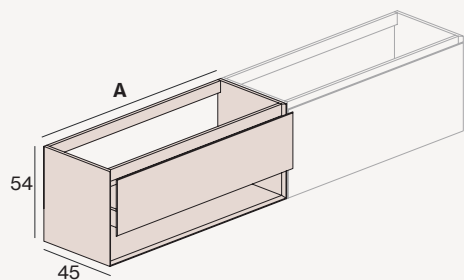

#### 2 GAVETAS

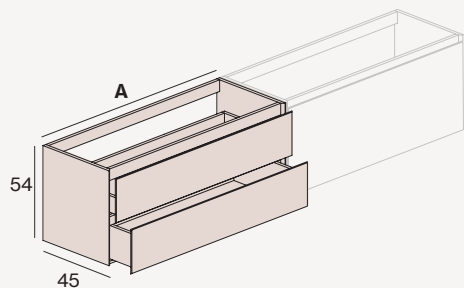

#### 2 PRATELEIRAS DECORATIVAS

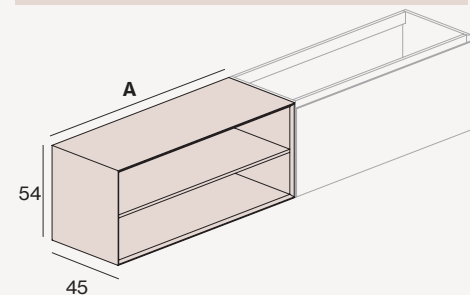

**& complementa**  
COMPLEMENTA  
SEUS MÓVEIS  
Organizadores, toalheiros, ...  
página 148

| A (cm) | REF        | LACA            |              | PRANCHA MADEIRA MARINHA |              |
|--------|------------|-----------------|--------------|-------------------------|--------------|
|        |            | PUXADOR DIAMOND | PUXADOR PUSH | PUXADOR DIAMOND         | PUXADOR PUSH |
| 30     | D202.030.M | -               | -            | -                       | -            |
| 40     | D202.040.M | -               | -            | -                       | -            |
| 60     | D202.060.M | -               | -            | -                       | -            |
| 70     | D202.070.M | -               | -            | -                       | -            |
| 80     | D202.080.M | -               | -            | -                       | -            |
| 90     | D202.090.M | -               | -            | -                       | -            |
| 100    | D202.100.M | -               | -            | -                       | -            |
| 120    | D202.120.M | -               | -            | -                       | -            |
| 140    | D202.140.M | -               | <b>ND</b>    | -                       | <b>ND</b>    |

|     |            |   |   |   |   |
|-----|------------|---|---|---|---|
| 30  | D203.030.M | - | - | - | - |
| 40  | D203.040.M | - | - | - | - |
| 60  | D203.060.M | - | - | - | - |
| 70  | D203.070.M | - | - | - | - |
| 80  | D203.080.M | - | - | - | - |
| 90  | D203.090.M | - | - | - | - |
| 100 | D203.100.M | - | - | - | - |
| 120 | D203.120.M | - | - | - | - |
| 140 | D203.140.M | - | - | - | - |

|     |            |   |   |   |   |
|-----|------------|---|---|---|---|
| 30  | D201.030.M | - | - | - | - |
| 40  | D201.040.M | - | - | - | - |
| 60  | D201.060.M | - | - | - | - |
| 70  | D201.070.M | - | - | - | - |
| 80  | D201.080.M | - | - | - | - |
| 90  | D201.090.M | - | - | - | - |
| 100 | D201.100.M | - | - | - | - |
| 120 | D201.120.M | - | - | - | - |
| 140 | D201.140.M | - | - | - | - |

|    |            |   |   |   |   |
|----|------------|---|---|---|---|
| 30 | D207.030.M | - | - | - | - |
| 40 | D207.040.M | - | - | - | - |
| 60 | D207.060.M | - | - | - | - |
| 70 | D207.070.M | - | - | - | - |
| 80 | D207.080.M | - | - | - | - |



#### (1) GAVETA INTERNA

A gaveta interna pode ser inserido as composições com o porta-malas.

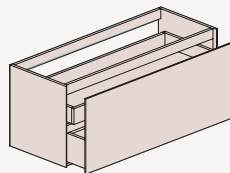

| A (cm) | REF      | PVP |
|--------|----------|-----|
| 40     | A221.040 | -   |
| 60     | A221.060 | -   |
| 70     | A221.070 | -   |
| 80     | A221.080 | -   |
| 90     | A221.090 | -   |
| 100    | A221.100 | -   |
| 120    | A221.120 | -   |
| 140    | A221.140 | -   |



# Best

|                              |     |
|------------------------------|-----|
| Recursos e equipamentos      | 124 |
| Personalize seus móveis Best | 125 |
| Bases de lavatórios          | 126 |
| Módulos suspensos            | 130 |
| Acessórios Atelier           | 148 |



### DECOSPACE SYSTEM

Sistema que fornece o fornecimento de um sifão que economiza espaço e uma válvula click clack em cromo polido. Esta solução evita o colapso da gaveta superior melhorando a capacidade de armazenamento e a estética interna, pois as estruturas estão ocultas.



### 4D GAVETAS

Gavetas Hettich ou Blum em metal antracite e perfil extrafino de 12 mm com 4 regulagens. Os guias possuem extensão total e sistema de frenagem progressiva.



### SOB MEDIDA

Esta coleção permite a fabricação sob encomenda. No caso de medidas intermediárias de altura e largura, calcule o preço da próxima medida superior.



### ANTRACITE FULLCOLOR

Conceito de design de interiores onde todos os materiais do interior do móvel são desenhados em antracite. O gabinete com acabamento lacado é lacado internamente em antracite.



### DURALACK SYSTEM

As cores lacadas contêm aditivos de endurecimento que permitem que o acabamento final seja altamente resistente a fricção e abrasão.



### PUSH AND SLOW

As gavetas com sistema de abertura Push sem puxadores possuem um sistema de sincronização que permite a sua abertura pressionando em qualquer parte da frente. Ao mesmo tempo, o fechamento é progressivo e silencioso.



### DECOFIX SYSTEM

Sistema de fixação de parede de alta segurança com o qual as resistências de carga são mais de 240 kg.



### DECOBUILD SYSTEM

Móveis feitos com placas de 19 mm colados com cutelos obtendo uma estética limpa sem encaixes visíveis e oferecendo maior resistência e durabilidade.



### WOOD PROTECT SYSTEM

As madeiras do mesa marina São protegidas de agentes externos com óleos naturais que respeitam a textura e natureza da madeira.



### ATELIER SYSTEM

Nos acabamentos marítimos, as peças são selecionadas de forma numerada para respeitar continuidade do grão em todo o gabinete.

## Configure e personalize seus melhores móveis

### A Escolha o puxador

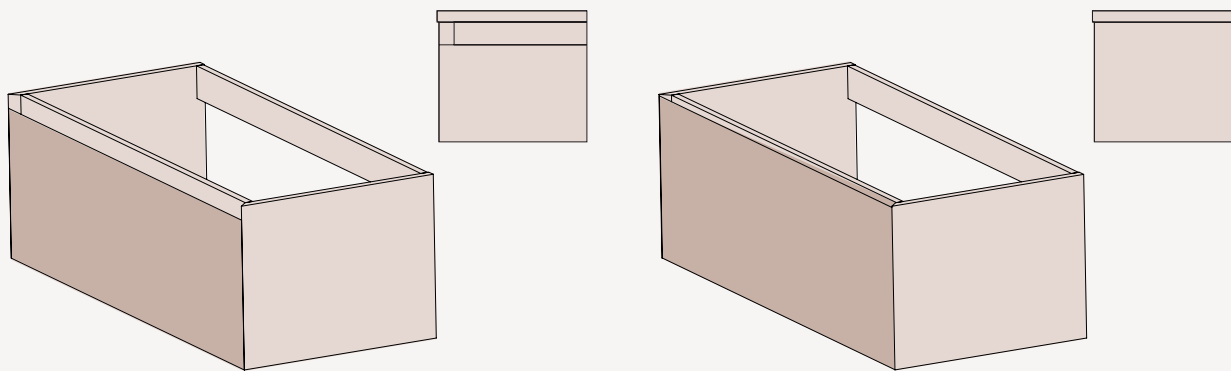

Best

Push

### B Escolha a cor

#### Lacado



#### Prancha Madeira Marinha / Folheado de Carvalho e Nogueira

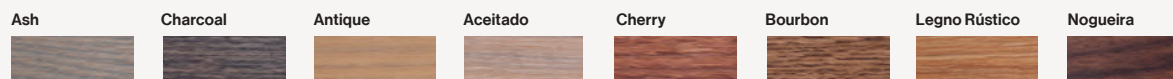

## BASES DE BACIA SUSPENSAS

## 1 GAVETA

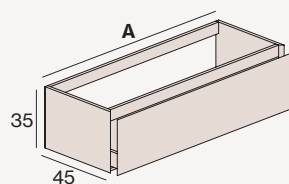

## 2 GAVETAS ASSIMÉTRICAS

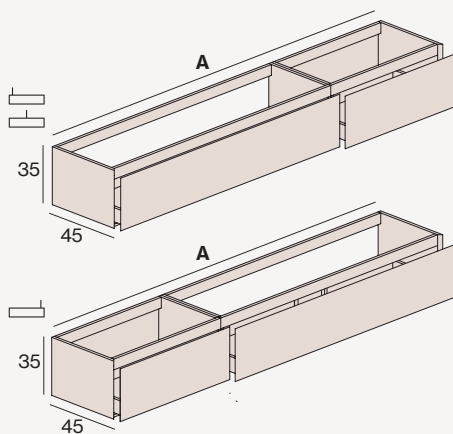

## 2 GAVETAS SIMÉTRICAS

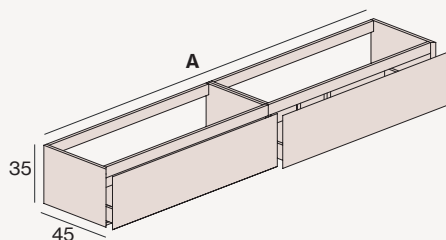

| A (cm) | LAVATÓRIO | REF        | LACA         |                | PRANCHA MADEIRA MARINHA |                |
|--------|-----------|------------|--------------|----------------|-------------------------|----------------|
|        |           |            | SHOOTER BEST | EMPURRAR PUXAR | SHOOTER BEST            | EMPURRAR PUXAR |
| 60     |           | B101.060.C | -            | -              | -                       | -              |
| 70     |           | B101.070.C | -            | -              | -                       | -              |
| 80     |           | B101.080.C | -            | -              | -                       | -              |
| 90     |           | B101.090.C | -            | -              | -                       | -              |
| 100    |           | B101.100.I | -            | -              | -                       | -              |
| 100    |           | B101.100.C | -            | -              | -                       | -              |
| 100    |           | B101.100.D | -            | -              | -                       | -              |
| 120    |           | B101.120.I | -            | -              | -                       | -              |
| 120    |           | B101.120.C | -            | -              | -                       | -              |
| 120    |           | B101.120.D | -            | -              | -                       | -              |
| 120    |           | B101.120.X | -            | -              | -                       | -              |
| 140    |           | B101.140.I | -            | -              | -                       | -              |
| 140    |           | B101.140.C | -            | -              | -                       | -              |
| 140    |           | B101.140.D | -            | -              | -                       | -              |
| 140    |           | B101.140.X | -            | -              | -                       | -              |
| 120    |           | B102.120.I | -            | -              | -                       | -              |
| 120    |           | B102.120.C | -            | -              | -                       | -              |
| 120    |           | B102.120.D | -            | -              | -                       | -              |
| 140    |           | B102.140.I | -            | -              | -                       | -              |
| 140    |           | B102.140.C | -            | -              | -                       | -              |
| 140    |           | B102.140.D | -            | -              | -                       | -              |
| 160    |           | B102.160.I | -            | -              | -                       | -              |
| 160    |           | B102.160.C | -            | -              | -                       | -              |
| 160    |           | B102.160.D | -            | -              | -                       | -              |
| 180    |           | B102.180.I | -            | -              | -                       | -              |
| 180    |           | B102.180.C | -            | -              | -                       | -              |
| 180    |           | B102.180.D | -            | -              | -                       | -              |
| 200    |           | B102.200.I | -            | -              | -                       | -              |
| 200    |           | B102.200.C | -            | -              | -                       | -              |
| 200    |           | B102.200.D | -            | -              | -                       | -              |
| 120    |           | B103.120.I | -            | -              | -                       | -              |
| 120    |           | B103.120.D | -            | -              | -                       | -              |
| 120    |           | B103.120.X | -            | -              | -                       | -              |
| 140    |           | B103.140.I | -            | -              | -                       | -              |
| 140    |           | B103.140.D | -            | -              | -                       | -              |
| 140    |           | B103.140.X | -            | -              | -                       | -              |
| 160    |           | B103.160.I | -            | -              | -                       | -              |
| 160    |           | B103.160.D | -            | -              | -                       | -              |
| 160    |           | B103.160.X | -            | -              | -                       | -              |
| 180    |           | B103.180.I | -            | -              | -                       | -              |
| 180    |           | B103.180.D | -            | -              | -                       | -              |
| 180    |           | B103.180.X | -            | -              | -                       | -              |
| 200    |           | B103.200.I | -            | -              | -                       | -              |
| 200    |           | B103.200.D | -            | -              | -                       | -              |
| 200    |           | B103.200.X | -            | -              | -                       | -              |



- As composições assimétricas têm a seguinte modulação: 120 (80 + 40), 140 (80 + 60), 160 (100 + 60), 180 (120 + 60), 200 (120 + 80). Outras configurações disponíveis.
- Móveis especiais: Para medidas intermediárias de largura e / ou altura, tome o preço da medida imediatamente superior.
- O gabinete de 35 alturas não possui sistema Decospace. Se a instalação permitir, pode ser encomendado sem custo adicional.

- C Lavatório centrado
- D Lavatório direita
- I Lavatório esquerda
- X Lavatório duplo

## BASES DE BACIA SUSPENSAS

## 2 GAVETAS

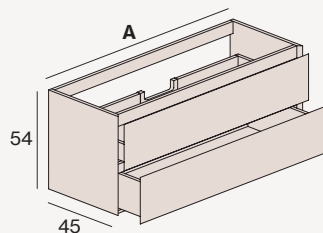

| A (cm) | LAVATÓRIO | REF        | LACA         |                | PRANCHA MADEIRA MARINHA |                |
|--------|-----------|------------|--------------|----------------|-------------------------|----------------|
|        |           |            | SHOOTER BEST | EMPURRAR PUXAR | SHOOTER BEST            | EMPURRAR PUXAR |
| 60     |           | B201.060.C | -            | -              | -                       | -              |
| 70     |           | B201.070.C | -            | -              | -                       | -              |
| 80     |           | B201.080.C | -            | -              | -                       | -              |
| 90     |           | B201.090.C | -            | -              | -                       | -              |
| 100    |           | B201.100.I | -            | -              | -                       | -              |
| 100    |           | B201.100.C | -            | -              | -                       | -              |
| 100    |           | B201.100.D | -            | -              | -                       | -              |
| 120    |           | B201.120.I | -            | -              | -                       | -              |
| 120    |           | B201.120.C | -            | -              | -                       | -              |
| 120    |           | B201.120.D | -            | -              | -                       | -              |
| 120    |           | B201.120.X | -            | -              | -                       | -              |
| 140    |           | B201.140.I | -            | -              | -                       | -              |
| 140    |           | B201.140.C | -            | -              | -                       | -              |
| 140    |           | B201.140.D | -            | -              | -                       | -              |
| 140    |           | B201.140.X | -            | -              | -                       | -              |

## 1 TRONCO

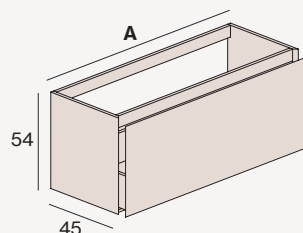

(1)

|     |  |            |   |    |   |    |
|-----|--|------------|---|----|---|----|
| 60  |  | B202.060.C | - | -  | - | -  |
| 70  |  | B202.070.C | - | -  | - | -  |
| 80  |  | B202.080.C | - | -  | - | -  |
| 90  |  | B202.090.C | - | -  | - | -  |
| 100 |  | B202.100.I | - | -  | - | -  |
| 100 |  | B202.100.C | - | -  | - | -  |
| 100 |  | B202.100.D | - | -  | - | -  |
| 120 |  | B202.120.I | - | -  | - | -  |
| 120 |  | B202.120.C | - | -  | - | -  |
| 120 |  | B202.120.D | - | -  | - | -  |
| 120 |  | B202.120.X | - | -  | - | -  |
| 140 |  | B202.140.I | - | ND | - | ND |
| 140 |  | B202.140.C | - | ND | - | ND |
| 140 |  | B202.140.D | - | ND | - | ND |
| 140 |  | B202.140.X | - | ND | - | ND |

## 1 GAVETA + DECORATIVA

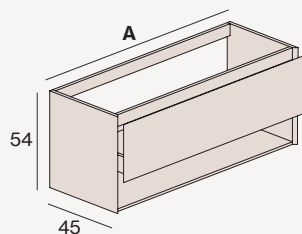

|     |  |            |   |   |   |   |
|-----|--|------------|---|---|---|---|
| 60  |  | B203.060.C | - | - | - | - |
| 70  |  | B203.070.C | - | - | - | - |
| 80  |  | B203.080.C | - | - | - | - |
| 90  |  | B203.090.C | - | - | - | - |
| 100 |  | B203.100.I | - | - | - | - |
| 100 |  | B203.100.C | - | - | - | - |
| 100 |  | B203.100.D | - | - | - | - |
| 120 |  | B203.120.I | - | - | - | - |
| 120 |  | B203.120.C | - | - | - | - |
| 120 |  | B203.120.D | - | - | - | - |
| 120 |  | B203.120.X | - | - | - | - |
| 140 |  | B203.140.I | - | - | - | - |
| 140 |  | B203.140.C | - | - | - | - |
| 140 |  | B203.140.D | - | - | - | - |
| 140 |  | B203.140.X | - | - | - | - |

Acessórios

## &amp; complementa

COMPLEMENTA  
SUA MÓVEL  
Organizadores, toalheiros, ...  
página 148

## (1) GAVETA INTERNA

A gaveta interna  
pode ser inserido  
as composições  
com o porta-malas.

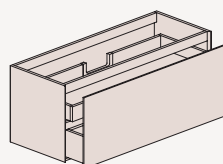

| A (cm) | REF       | PVP |
|--------|-----------|-----|
| 40     | A220.040  | -   |
| 60     | A220.060  | -   |
| 70     | A220.070  | -   |
| 80     | A220.080  | -   |
| 90     | A220.090  | -   |
| 100    | A220.100  | -   |
| 120    | A220.120  | -   |
| 120X   | A220.120X | -   |
| 140    | A220.140  | -   |
| 140X   | A220.140X | -   |

## BASES DE BACIA SUSPENSAS

## 1 TRONCO + 2 GAVETAS ASSIMÉTRICAS

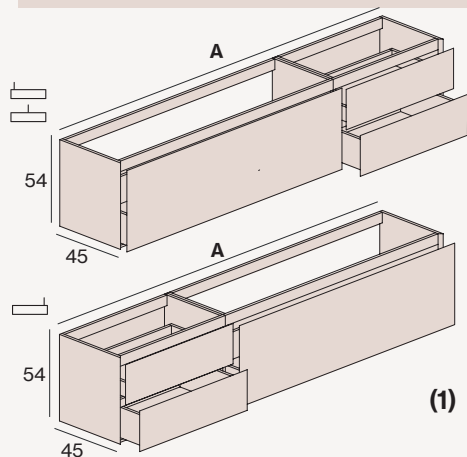

## 1 TRONCO + 2 GAVETAS SIMÉTRICAS

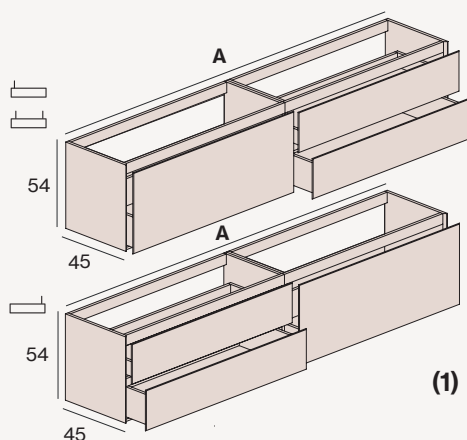

## 4 GAVETAS ASSIMÉTRICAS

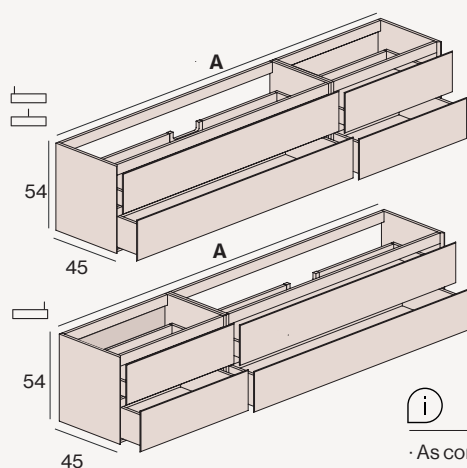

| A (cm) | LAVATÓRIO | REF        | LACA         |                | PRANCHA MADEIRA MARINHA |                |
|--------|-----------|------------|--------------|----------------|-------------------------|----------------|
|        |           |            | SHOOTER BEST | EMPURRAR PUXAR | SHOOTER BEST            | EMPURRAR PUXAR |
| 120    |           | B205.120.I | -            | -              | -                       | -              |
| 120    |           | B205.120.C | -            | -              | -                       | -              |
| 120    |           | B205.120.D | -            | -              | -                       | -              |
| 140    |           | B205.140.I | -            | -              | -                       | -              |
| 140    |           | B205.140.C | -            | -              | -                       | -              |
| 140    |           | B205.140.D | -            | -              | -                       | -              |
| 160    |           | B205.160.I | -            | -              | -                       | -              |
| 160    |           | B205.160.C | -            | -              | -                       | -              |
| 160    |           | B205.160.D | -            | -              | -                       | -              |
| 180    |           | B205.180.I | -            | -              | -                       | -              |
| 180    |           | B205.180.C | -            | -              | -                       | -              |
| 180    |           | B205.180.D | -            | -              | -                       | -              |
| 200    |           | B205.200.I | -            | -              | -                       | -              |
| 200    |           | B205.200.C | -            | -              | -                       | -              |
| 200    |           | B205.200.D | -            | -              | -                       | -              |
| <hr/>  |           |            |              |                |                         |                |
| 120    |           | B206.120.I | -            | -              | -                       | -              |
| 120    |           | B206.120.D | -            | -              | -                       | -              |
| 120    |           | B206.120.X | -            | -              | -                       | -              |
| 140    |           | B206.140.I | -            | -              | -                       | -              |
| 140    |           | B206.140.D | -            | -              | -                       | -              |
| 140    |           | B206.140.X | -            | -              | -                       | -              |
| 160    |           | B206.160.I | -            | -              | -                       | -              |
| 160    |           | B206.160.D | -            | -              | -                       | -              |
| 160    |           | B206.160.X | -            | -              | -                       | -              |
| 180    |           | B206.180.I | -            | -              | -                       | -              |
| 180    |           | B206.180.D | -            | -              | -                       | -              |
| 180    |           | B206.180.X | -            | -              | -                       | -              |
| 200    |           | B206.200.I | -            | -              | -                       | -              |
| 200    |           | B206.200.D | -            | -              | -                       | -              |
| 200    |           | B206.200.X | -            | -              | -                       | -              |
| <hr/>  |           |            |              |                |                         |                |
| 120    |           | B208.120.I | -            | -              | -                       | -              |
| 120    |           | B208.120.C | -            | -              | -                       | -              |
| 120    |           | B208.120.D | -            | -              | -                       | -              |
| 140    |           | B208.140.I | -            | -              | -                       | -              |
| 140    |           | B208.140.C | -            | -              | -                       | -              |
| 140    |           | B208.140.D | -            | -              | -                       | -              |
| 160    |           | B208.160.I | -            | -              | -                       | -              |
| 160    |           | B208.160.C | -            | -              | -                       | -              |
| 160    |           | B208.160.D | -            | -              | -                       | -              |
| 180    |           | B208.180.I | -            | -              | -                       | -              |
| 180    |           | B208.180.C | -            | -              | -                       | -              |
| 180    |           | B208.180.D | -            | -              | -                       | -              |
| 200    |           | B208.200.I | -            | -              | -                       | -              |
| 200    |           | B208.200.C | -            | -              | -                       | -              |
| 200    |           | B208.200.D | -            | -              | -                       | -              |



- As composições assimétricas têm a seguinte modulação:  
120 (80 + 40), 140 (80 + 60), 160 (100 + 60), 180 (120 + 60), 200 (120 + 80).  
Outras configurações disponíveis.
- Móveis especiais: Para medidas intermediárias de largura e / ou altura, tome o preço da medida imediatamente superior.
- O gabinete de 35 alturas não possui sistema Decospace. Se a instalação permitir, pode ser encomendado sem custo adicional.

- C Lavatório centrado
- D Lavatório direita
- I Lavatório esquerda
- X Lavatório duplo



**BASES DE BACIA SUSPENSAS**

**4 GAVETAS SIMÉTRICAS**

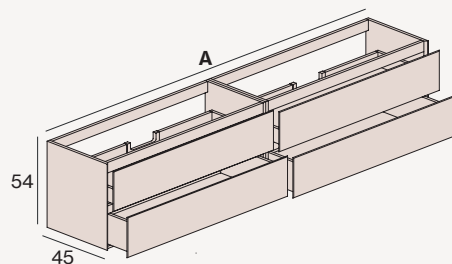

| A (cm) | SINK | REF        | LACA         |                | PRANCHA MADEIRA MARINHA |                |
|--------|------|------------|--------------|----------------|-------------------------|----------------|
|        |      |            | SHOOTER BEST | EMPURRAR PUXAR | SHOOTER BEST            | EMPURRAR PUXAR |
| 120    |      | B209.120.I | -            | -              | -                       | -              |
| 120    |      | B209.120.D | -            | -              | -                       | -              |
| 120    |      | B209.120.X | -            | -              | -                       | -              |
| 140    |      | B209.140.I | -            | -              | -                       | -              |
| 140    |      | B209.140.D | -            | -              | -                       | -              |
| 140    |      | B209.140.X | -            | -              | -                       | -              |
| 160    |      | B209.160.I | -            | -              | -                       | -              |
| 160    |      | B209.160.D | -            | -              | -                       | -              |
| 160    |      | B209.160.X | -            | -              | -                       | -              |
| 180    |      | B209.180.I | -            | -              | -                       | -              |
| 180    |      | B209.180.D | -            | -              | -                       | -              |
| 180    |      | B209.180.X | -            | -              | -                       | -              |
| 200    |      | B209.200.I | -            | -              | -                       | -              |
| 200    |      | B209.200.D | -            | -              | -                       | -              |
| 200    |      | B209.200.X | -            | -              | -                       | -              |

**2 TRONCOS SIMÉTRICOS**

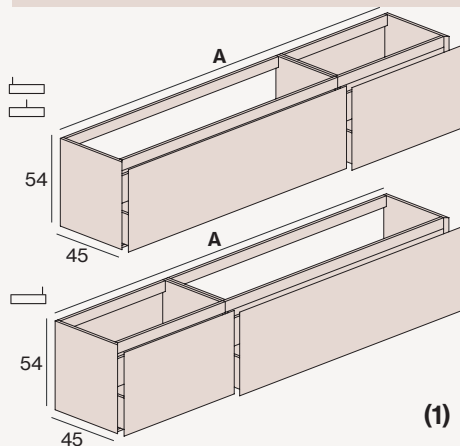

|     |  |            |   |   |   |   |
|-----|--|------------|---|---|---|---|
| 120 |  | B210.120.I | - | - | - | - |
| 120 |  | B210.120.C | - | - | - | - |
| 120 |  | B210.120.D | - | - | - | - |
| 140 |  | B210.140.I | - | - | - | - |
| 140 |  | B210.140.C | - | - | - | - |
| 140 |  | B210.140.D | - | - | - | - |
| 160 |  | B210.160.I | - | - | - | - |
| 160 |  | B210.160.C | - | - | - | - |
| 160 |  | B210.160.D | - | - | - | - |
| 180 |  | B210.180.I | - | - | - | - |
| 180 |  | B210.180.C | - | - | - | - |
| 180 |  | B210.180.D | - | - | - | - |
| 200 |  | B210.200.I | - | - | - | - |
| 200 |  | B210.200.C | - | - | - | - |
| 200 |  | B210.200.D | - | - | - | - |

**2 TRONCOS SIMÉTRICOS**

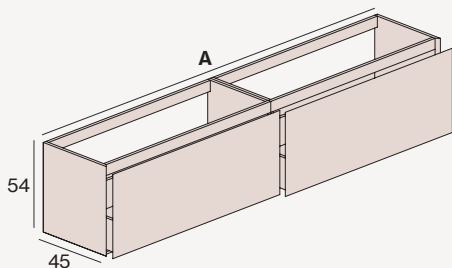

|     |  |            |   |   |   |   |
|-----|--|------------|---|---|---|---|
| 120 |  | B211.120.I | - | - | - | - |
| 120 |  | B211.120.D | - | - | - | - |
| 120 |  | B211.120.X | - | - | - | - |
| 140 |  | B211.140.I | - | - | - | - |
| 140 |  | B211.140.D | - | - | - | - |
| 140 |  | B211.140.X | - | - | - | - |
| 160 |  | B211.160.I | - | - | - | - |
| 160 |  | B211.160.D | - | - | - | - |
| 160 |  | B211.160.X | - | - | - | - |
| 180 |  | B211.180.I | - | - | - | - |
| 180 |  | B211.180.D | - | - | - | - |
| 180 |  | B211.180.X | - | - | - | - |
| 200 |  | B211.200.I | - | - | - | - |
| 200 |  | B211.200.D | - | - | - | - |
| 200 |  | B211.200.X | - | - | - | - |

Acessórios

**& complementa**  
COMPLEMENTA  
SUA MÓVEL  
Organizadores, toalheiros, ...  
página 148

**(1) GAVETA INTERNA**

A gaveta interna pode ser inserido as composições com o porta-malas.

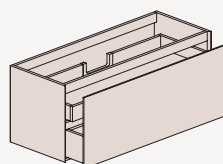

| A (cm) | REF       | PVP |
|--------|-----------|-----|
| 40     | A220.040  | -   |
| 60     | A220.060  | -   |
| 70     | A220.070  | -   |
| 80     | A220.080  | -   |
| 90     | A220.090  | -   |
| 100    | A220.100  | -   |
| 120    | A220.120  | -   |
| 120X   | A220.120X | -   |
| 140    | A220.140  | -   |
| 140X   | A220.140X | -   |

MÓDULOS SUSPENSOS

1 GAVETA / BANCO

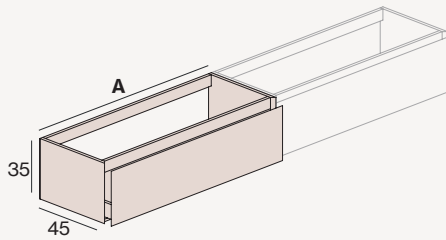

| A (cm) | REF        | LACA         |                | PRANCHA MADEIRA MARINHA |                |
|--------|------------|--------------|----------------|-------------------------|----------------|
|        |            | SHOOTER BEST | EMPURRAR PUXAR | SHOOTER BEST            | EMPURRAR PUXAR |
| 30     | B101.030.M | -            | -              | -                       | -              |
| 40     | B101.040.M | -            | -              | -                       | -              |
| 60     | B101.060.M | -            | -              | -                       | -              |
| 70     | B101.070.M | -            | -              | -                       | -              |
| 80     | B101.080.M | -            | -              | -                       | -              |
| 90     | B101.090.M | -            | -              | -                       | -              |
| 100    | B101.100.M | -            | -              | -                       | -              |
| 120    | B101.120.M | -            | -              | -                       | -              |
| 140    | B101.140.M | -            | -              | -                       | -              |

2 GAVETAS / BANCO

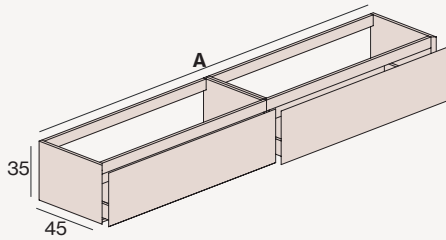

|     |            |   |   |   |   |
|-----|------------|---|---|---|---|
| 120 | B103.120.M | - | - | - | - |
| 140 | B103.140.M | - | - | - | - |
| 160 | B103.160.M | - | - | - | - |
| 180 | B103.180.M | - | - | - | - |
| 200 | B103.200.M | - | - | - | - |

DECORATIVO

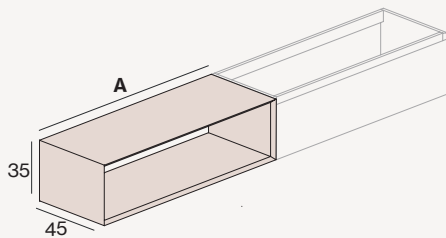

|    |            |   |   |   |   |
|----|------------|---|---|---|---|
| 30 | B104.030.M | - | - | - | - |
| 40 | B104.040.M | - | - | - | - |
| 60 | B104.060.M | - | - | - | - |
| 70 | B104.070.M | - | - | - | - |
| 80 | B104.080.M | - | - | - | - |

MÓDULOS SUSPENSOS

1 TRONCO

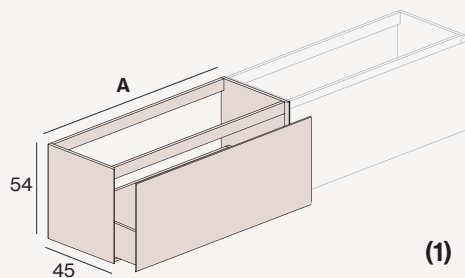

| A (cm) | REF        | LACA         |                | PRANCHA MADEIRA MARINHA |                |
|--------|------------|--------------|----------------|-------------------------|----------------|
|        |            | SHOOTER BEST | EMPURRAR PUXAR | SHOOTER BEST            | EMPURRAR PUXAR |
| 30     | B202.030.M | -            | -              | -                       | -              |
| 40     | B202.040.M | -            | -              | -                       | -              |
| 60     | B202.060.M | -            | -              | -                       | -              |
| 70     | B202.070.M | -            | -              | -                       | -              |
| 80     | B202.080.M | -            | -              | -                       | -              |
| 90     | B202.090.M | -            | -              | -                       | -              |
| 100    | B202.100.M | -            | -              | -                       | -              |
| 120    | B202.120.M | -            | -              | -                       | -              |
| 140    | B202.140.M | -            | ND             | -                       | ND             |

1 GAVETA + DECORATIVA

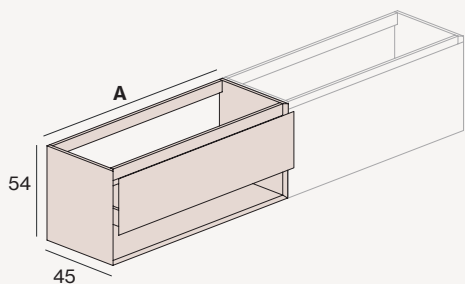

|     |            |   |   |   |   |
|-----|------------|---|---|---|---|
| 30  | B203.030.M | - | - | - | - |
| 40  | B203.040.M | - | - | - | - |
| 60  | B203.060.M | - | - | - | - |
| 70  | B203.070.M | - | - | - | - |
| 80  | B203.080.M | - | - | - | - |
| 90  | B203.090.M | - | - | - | - |
| 100 | B203.100.M | - | - | - | - |
| 120 | B203.120.M | - | - | - | - |
| 140 | B203.140.M | - | - | - | - |

2 GAVETAS

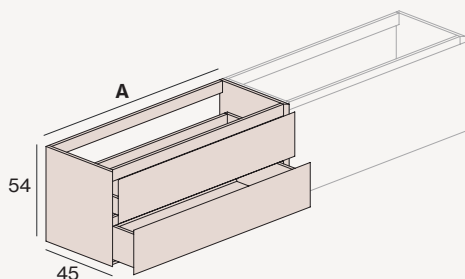

|     |            |   |   |   |   |
|-----|------------|---|---|---|---|
| 30  | B201.030.M | - | - | - | - |
| 40  | B201.040.M | - | - | - | - |
| 60  | B201.060.M | - | - | - | - |
| 70  | B201.070.M | - | - | - | - |
| 80  | B201.080.M | - | - | - | - |
| 90  | B201.090.M | - | - | - | - |
| 100 | B201.100.M | - | - | - | - |
| 120 | B201.120.M | - | - | - | - |
| 140 | B201.140.M | - | - | - | - |

DECORATIVO 2 ESTANTES

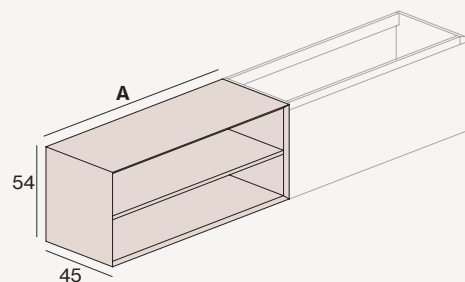

|    |            |   |   |   |   |
|----|------------|---|---|---|---|
| 30 | B207.030.M | - | - | - | - |
| 40 | B207.040.M | - | - | - | - |
| 60 | B207.060.M | - | - | - | - |
| 70 | B207.070.M | - | - | - | - |
| 80 | B207.080.M | - | - | - | - |

(1) GAVETA INTERNA

A gaveta interna pode ser inserido as composições com o porta-malas.

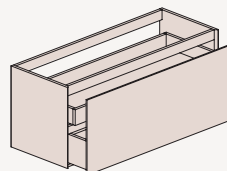

| A (cm) | REF      | PVP |
|--------|----------|-----|
| 40     | A221.040 | -   |
| 60     | A221.060 | -   |
| 70     | A221.070 | -   |
| 80     | A221.080 | -   |
| 90     | A221.090 | -   |
| 100    | A221.100 | -   |
| 120    | A221.120 | -   |
| 140    | A221.140 | -   |



Você pode criar seu mobiliário personalizado adicionando os módulos à direita e / ou esquerda da base da bacia selecionada e complementos. Especifique sua posição.

**& complementa**  
COMPLEMENTA SUA MÓVEL  
Organizadores, toalheiros, ...  
página 148



# Queen

|                               |     |
|-------------------------------|-----|
| Recursos e equipamentos       | 134 |
| Personalize seus móveis Queen | 135 |
| Bases de lavatório suspensas  | 136 |
| Módulos suspensos             | 139 |
| Acessório Atelier             | 148 |



## DECOSPACE SYSTEM

Sistema que fornece o fornecimento de um sifão que economiza espaço e uma válvula click clack em cromo polido. Esta solução evita o colapso da gaveta superior melhorando a capacidade de armazenamento e a estética interna, pois as estruturas estão ocultas.



## 4D GAVETAS

Gavetas Hettich ou Blum em metal antracite e perfil extrafino de 12 mm com 4 regulagens. Os guias possuem extensão total e sistema de frenagem progressiva.



## SOB MEDIDA

Esta coleção permite a fabricação sob medida. No caso de medidas intermediárias de altura e largura, calcule o preço da próxima medida superior.



## ANTRACITE FULLCOLOR

Conceito de design de interiores onde todos os materiais do interior do móvel são desenhados em antracite. O gabinete com acabamento lacado é lacado internamente em antracite.



## DURALACK SYSTEM

As cores lacadas contêm aditivos de endurecimento que permitem que o acabamento final seja altamente resistente a fricção e abrasão.



## DECOFIX SYSTEM

Sistema de fixação de parede de alta segurança com o qual as resistências de carga são mais de 240 kg.



## DECOBUILD SYSTEM

Móveis feitos com placas de 19 mm coladas com cutelos obtendo uma estética limpa sem encaixes visíveis e oferecendo maior resistência e durabilidade.

O Queen torna isso mais fácil para você. Para personalizar seus móveis, basta escolher a cor e o puxador desejado

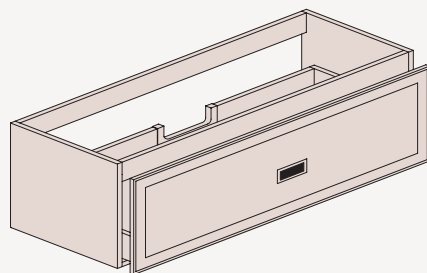

**A** Escolha a sua cor lacada



\* Disponível em todas as cores RAL

**B** Escolha o seu tirante

Ouro brilho

Aresta decorada



Puxador

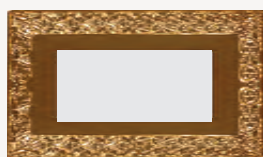

Cromo brilho

Aresta decorada

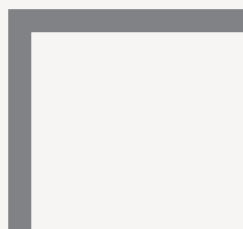

Puxador



## BASES PARA LAVATÓRIO PENDURADO NA PAREDE

## 1 GAVETA

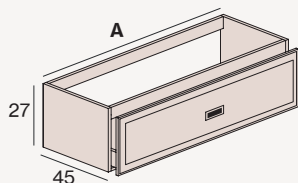

| A (cm) | LAVELLO | REF        | PVP |
|--------|---------|------------|-----|
| 60     |         | Q101.060.C | -   |
| 70     |         | Q101.070.C | -   |
| 80     |         | Q101.080.C | -   |
| 90     |         | Q101.090.C | -   |
| 100    |         | Q101.100.I | -   |
| 100    |         | Q101.100.C | -   |
| 100    |         | Q101.100.D | -   |
| 120    |         | Q101.120.I | -   |
| 120    |         | Q101.120.C | -   |
| 120    |         | Q101.120.D | -   |
| 120    |         | Q101.120.X | -   |
| 140    |         | Q101.140.I | -   |
| 140    |         | Q101.140.C | -   |
| 140    |         | Q101.140.D | -   |
| 140    |         | Q101.140.X | -   |

## 2 GAVETAS ASSIMÉTRICAS

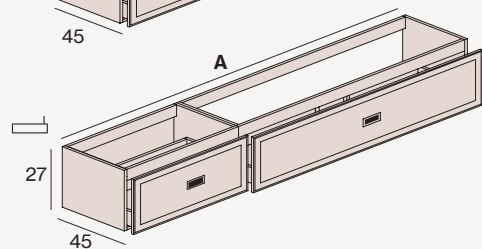
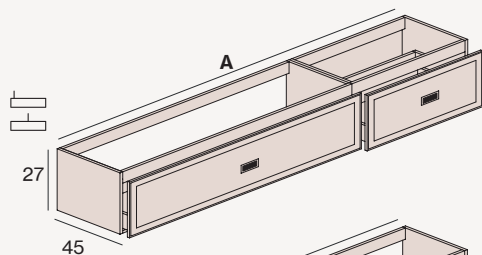

|     |  |            |   |
|-----|--|------------|---|
| 120 |  | Q102.120.I | - |
| 120 |  | Q102.120.C | - |
| 120 |  | Q102.120.D | - |
| 140 |  | Q102.140.I | - |
| 140 |  | Q102.140.C | - |
| 140 |  | Q102.140.D | - |
| 160 |  | Q102.160.I | - |
| 160 |  | Q102.160.C | - |
| 160 |  | Q102.160.D | - |
| 180 |  | Q102.180.I | - |
| 180 |  | Q102.180.C | - |
| 180 |  | Q102.180.D | - |
| 200 |  | Q102.200.I | - |
| 200 |  | Q102.200.C | - |
| 200 |  | Q102.200.D | - |

## 2 GAVETAS SIMÉTRICAS

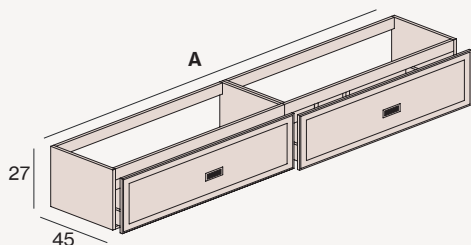

|     |  |            |   |
|-----|--|------------|---|
| 120 |  | Q103.120.I | - |
| 120 |  | Q103.120.D | - |
| 120 |  | Q103.120.X | - |
| 140 |  | Q103.140.I | - |
| 140 |  | Q103.140.D | - |
| 140 |  | Q103.140.X | - |
| 160 |  | Q103.160.I | - |
| 160 |  | Q103.160.D | - |
| 160 |  | Q103.160.X | - |
| 180 |  | Q103.180.I | - |
| 180 |  | Q103.180.D | - |
| 180 |  | Q103.180.X | - |
| 200 |  | Q103.200.I | - |
| 200 |  | Q103.200.D | - |
| 200 |  | Q103.200.X | - |



- As composições assimétricas têm a seguinte modulação: 120 (80 + 40), 140 (80 + 60), 160 (100 + 60), 180 (120 + 60), 200 (120 + 80). Outras configurações disponíveis.
- Móveis especiais: para medidas intermediárias em largura e / ou altura, leve a preço do próximo tamanho superior. Fundo especial disponível de 39 a 45 cm. Consulte outros fundos.
- O gabinete de 27 alturas não possui sistema Decospace. Se a instalação permitir, pode ser encomendado sem custo adicional.

- C Lavatório centrado
- D Lavatório direita
- E Lavatório esquerda
- X Lavatório duplo



## BASES PARA LAVATÓRIO PENDURADO NA PAREDE

## 2 GAVETAS

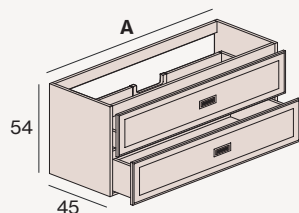

| A (cm) | LAVELLO | REF        | PVP |
|--------|---------|------------|-----|
| 60     |         | Q201.060.C | -   |
| 70     |         | Q201.070.C | -   |
| 80     |         | Q201.080.C | -   |
| 90     |         | Q201.090.C | -   |
| 100    |         | Q201.100.I | -   |
| 100    |         | Q201.100.C | -   |
| 100    |         | Q201.100.D | -   |
| 120    |         | Q201.120.I | -   |
| 120    |         | Q201.120.C | -   |
| 120    |         | Q201.120.D | -   |
| 120    |         | Q201.120.X | -   |
| 140    |         | Q201.140.I | -   |
| 140    |         | Q201.140.C | -   |
| 140    |         | Q201.140.D | -   |
| 140    |         | Q201.140.X | -   |

## 4 GAVETAS ASSIMÉTRICAS

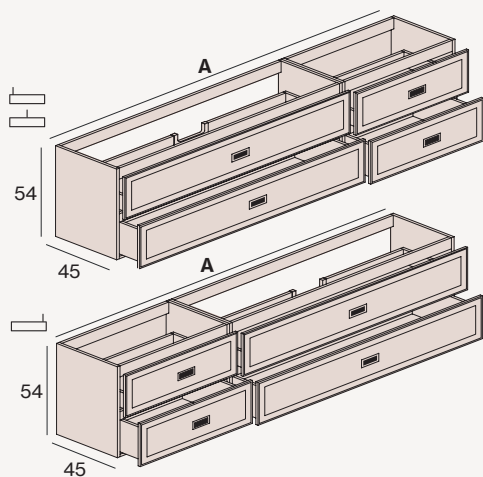

|     |  |            |   |
|-----|--|------------|---|
| 120 |  | Q208.120.I | - |
| 120 |  | Q208.120.C | - |
| 120 |  | Q208.120.D | - |
| 140 |  | Q208.140.I | - |
| 140 |  | Q208.140.C | - |
| 140 |  | Q208.140.D | - |
| 160 |  | Q208.160.I | - |
| 160 |  | Q208.160.C | - |
| 160 |  | Q208.160.D | - |
| 180 |  | Q208.180.I | - |
| 180 |  | Q208.180.C | - |
| 180 |  | Q208.180.D | - |
| 200 |  | Q208.200.I | - |
| 200 |  | Q208.200.C | - |
| 200 |  | Q208.200.D | - |

## 4 GAVETAS SIMÉTRICAS

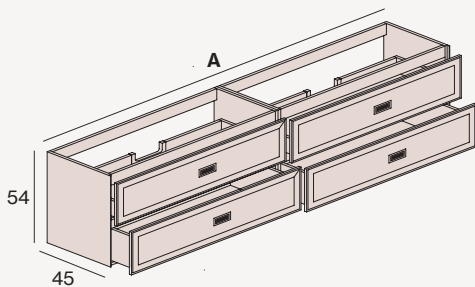

|     |  |            |   |
|-----|--|------------|---|
| 120 |  | Q209.120.I | - |
| 120 |  | Q209.120.D | - |
| 120 |  | Q209.120.X | - |
| 140 |  | Q209.140.I | - |
| 140 |  | Q209.140.D | - |
| 140 |  | Q209.140.X | - |
| 160 |  | Q209.160.I | - |
| 160 |  | Q209.160.D | - |
| 160 |  | Q209.160.X | - |
| 180 |  | Q209.180.I | - |
| 180 |  | Q209.180.D | - |
| 180 |  | Q209.180.X | - |
| 200 |  | Q209.200.I | - |
| 200 |  | Q209.200.D | - |
| 200 |  | Q209.200.X | - |

## Acessórios

## &amp; complementa

COMPLEMENTA  
SEUS MÓVEIS  
Organizadores, toalheiros, ...  
página 148

## BASES PARA LAVATÓRIO PENDURADO NA PAREDE

## 3 GAVETAS

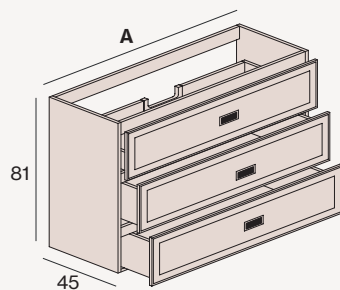

| A (cm) | LAVELLO | REF        | PVP |
|--------|---------|------------|-----|
| 60     |         | Q213.060.C | -   |
| 70     |         | Q213.070.C | -   |
| 80     |         | Q213.080.C | -   |
| 90     |         | Q213.090.C | -   |
| 100    |         | Q213.100.I | -   |
| 100    |         | Q213.100.C | -   |
| 100    |         | Q213.100.D | -   |



- As composições assimétricas têm a seguinte modulação: 120 (80 + 40), 140 (80 + 60), 160 (100 + 60), 180 (120 + 60), 200 (120 + 80). Outras configurações disponíveis.
- Móveis especiais: para medidas intermediárias de largura e / ou altura, calcule o preço da próxima medida superior. Fundo especial disponível de 39 a 45 cm. Consulte outros fundos.

- C Lavatório centrado
- D Lavatório direita
- I Lavatório esquerda
- X Lavatório duplo

## MÓDULOS SUSPENSOS

## 1 GAVETA / BANCO

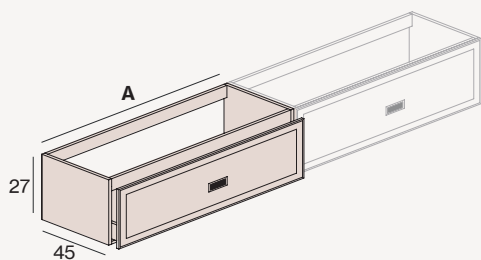

| A (cm) | REF        | PUXADOR | PVP |
|--------|------------|---------|-----|
| 40     | Q101.040.M | -       | -   |
| 60     | Q101.060.M | -       | -   |
| 70     | Q101.070.M | -       | -   |
| 80     | Q101.080.M | -       | -   |
| 90     | Q101.090.M | -       | -   |
| 100    | Q101.100.M | -       | -   |
| 120    | Q101.120.M | -       | -   |
| 140    | Q101.140.M | -       | -   |

## 2 GAVETAS

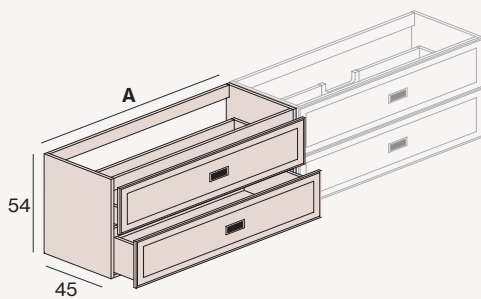

|     |            |   |   |
|-----|------------|---|---|
| 40  | Q201.040.M | - | - |
| 60  | Q201.060.M | - | - |
| 70  | Q201.070.M | - | - |
| 80  | Q201.080.M | - | - |
| 90  | Q201.090.M | - | - |
| 100 | Q201.100.M | - | - |
| 120 | Q201.120.M | - | - |
| 140 | Q201.140.M | - | - |

## 3 GAVETAS

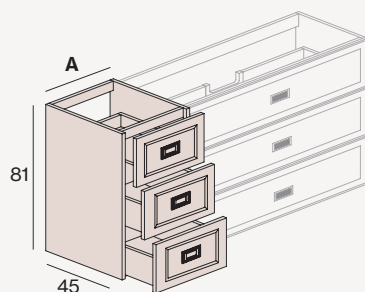

|     |            |   |   |
|-----|------------|---|---|
| 40  | Q313.040.M | - | - |
| 60  | Q313.060.M | - | - |
| 70  | Q313.070.M | - | - |
| 80  | Q313.080.M | - | - |
| 90  | Q313.090.M | - | - |
| 100 | Q313.100.M | - | - |

**& complementa**

COMPLEMENTA  
SEUS MÓVEIS  
Organizadores, toalheiros, ...  
página 148

· Você pode criar seus próprios móveis personalizados adicionando os módulos à direita e / ou à esquerda da base do lavatório selecionada. Especifique sua localização.



# Alma by CÍRCULO CUADRADO

|                               |     |
|-------------------------------|-----|
| Recursos e equipamentos       | 142 |
| Personalize seus móveis Alma  | 143 |
| Bases de lavatórios suspensos | 144 |
| Módulos suspensos             | 146 |
| Acessórios Atelier            | 148 |



## DECOSPACE SYSTEM

Sistema que fornece o fornecimento de um sifão que economiza espaço e uma válvula click clack em cromo polido. Esta solução evita o colapso da gaveta superior melhorando a capacidade de armazenamento e a estética interna, pois as estruturas estão ocultas.



## 4D GAVETAS

Gavetas Hettich ou Blum em metal antracite e perfil extrafino de 12 mm com 4 regulagens. Os guias possuem extensão total e sistema de frenagem progressiva.



## SOB MEDIDA

Esta coleção permite a fabricação sob medida. No caso de medidas intermediárias de altura e largura, calcule o preço da próxima medida superior.



## ANTRACITE FULLCOLOR

Conceito de design de interiores onde todos os materiais do interior do móvel são desenhados em antracite. O gabinete com acabamento lacado é lacado internamente em antracite.



## DURALACK SYSTEM

As cores lacadas contêm aditivos de endurecimento que permitem que o acabamento final seja altamente resistente a fricção e abrasão.



## PUSH AND SLOW

As gavetas com sistema de abertura Push sem puxadores possuem um sistema de sincronização que permite a sua abertura pressionando em qualquer parte da frente. Ao mesmo tempo, o fechamento é progressivo e silencioso.



## DECOFIX SYSTEM

Sistema de fixação de parede de alta segurança com o qual as resistências de carga são mais de 240 kg.



## DECOBUILD SYSTEM

Móveis feitos com placas de 19 mm colados com cutelos obtendo uma estética limpa sem encaixes visíveis e oferecendo maior resistência e durabilidade.



## WOOD PROTECT SYSTEM

As madeiras do mesa marina São protegidas de agentes externos com óleos naturais que respeitam a textura e natureza da madeira.



## ATELIER SYSTEM

Nos acabamentos marítimos, as peças são selecionadas de forma numerada para respeitar continuidade do grão em todo o gabinete.

## Configure e personalize seus móveis Alma

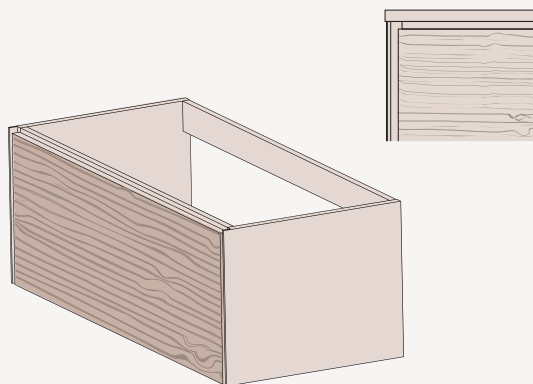

Frontal Madera

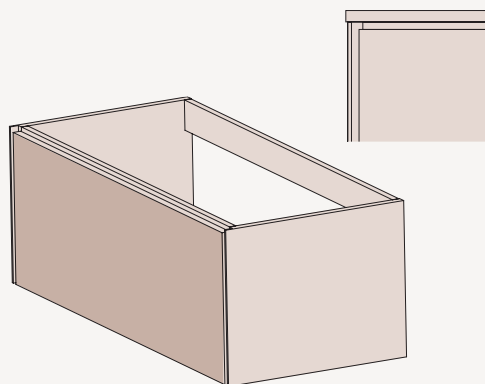

Frontal Lacado

### A Escolha a cor da estrutura do móvel

#### Lacado



### B Escolha a cor do PUSH frontal

#### Lacado



#### Prancha Madeira Marinha / Folheado de Carvalho e Nogueira

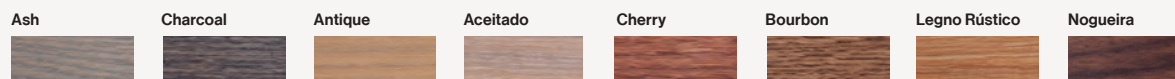

#### Madeira Maciça / Carvalho



## BASES DE BACIA SUSPENSAS

## 1 GAVETA

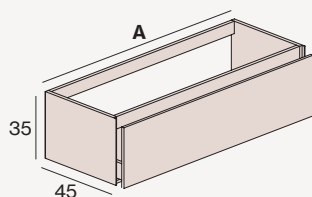

| A (cm)                            | LAVATÓRIO | REF        | LACA | PRANCHA MADEIRA MARINHA | MADEIRA SÓLIDA |
|-----------------------------------|-----------|------------|------|-------------------------|----------------|
| (apenas frente, estrutura lacada) |           |            |      |                         |                |
| 60                                |           | A101.060.C | -    | -                       | -              |
| 70                                |           | A101.070.C | -    | -                       | -              |
| 80                                |           | A101.080.C | -    | -                       | -              |
| 90                                |           | A101.090.C | -    | -                       | -              |
| 100                               |           | A101.100.I | -    | -                       | -              |
| 100                               |           | A101.100.C | -    | -                       | -              |
| 100                               |           | A101.100.D | -    | -                       | -              |
| 120                               |           | A101.120.I | -    | -                       | -              |
| 120                               |           | A101.120.C | -    | -                       | -              |
| 120                               |           | A101.120.D | -    | -                       | -              |
| 120                               |           | A101.120.X | -    | -                       | -              |
| 140                               |           | A101.140.I | -    | -                       | -              |
| 140                               |           | A101.140.C | -    | -                       | -              |
| 140                               |           | A101.140.D | -    | -                       | -              |
| 140                               |           | A101.140.X | -    | -                       | -              |

## 2 GAVETAS ASSIMÉTRICAS

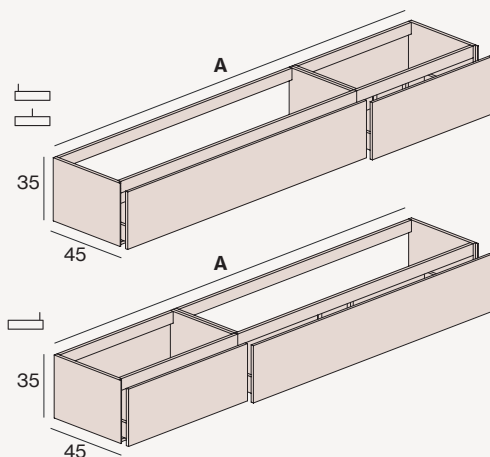

|     |  |            |   |   |   |
|-----|--|------------|---|---|---|
| 120 |  | A102.120.I | - | - | - |
| 120 |  | A102.120.C | - | - | - |
| 120 |  | A102.120.D | - | - | - |
| 140 |  | A102.140.I | - | - | - |
| 140 |  | A102.140.C | - | - | - |
| 140 |  | A102.140.D | - | - | - |
| 160 |  | A102.160.I | - | - | - |
| 160 |  | A102.160.C | - | - | - |
| 160 |  | A102.160.D | - | - | - |
| 180 |  | A102.180.I | - | - | - |
| 180 |  | A102.180.C | - | - | - |
| 180 |  | A102.180.D | - | - | - |
| 200 |  | A102.200.I | - | - | - |
| 200 |  | A102.200.C | - | - | - |
| 200 |  | A102.200.D | - | - | - |

## 2 GAVETAS SIMÉTRICAS

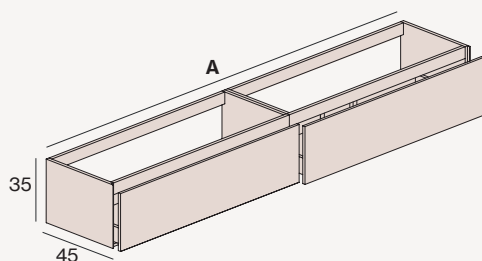

|     |  |            |   |   |   |
|-----|--|------------|---|---|---|
| 120 |  | A103.120.I | - | - | - |
| 120 |  | A103.120.D | - | - | - |
| 120 |  | A103.120.X | - | - | - |
| 140 |  | A103.140.I | - | - | - |
| 140 |  | A103.140.D | - | - | - |
| 140 |  | A103.140.X | - | - | - |
| 160 |  | A103.160.I | - | - | - |
| 160 |  | A103.160.D | - | - | - |
| 160 |  | A103.160.X | - | - | - |
| 180 |  | A103.180.I | - | - | - |
| 180 |  | A103.180.D | - | - | - |
| 180 |  | A103.180.X | - | - | - |
| 200 |  | A103.200.I | - | - | - |
| 200 |  | A103.200.D | - | - | - |
| 200 |  | A103.200.X | - | - | - |



- As composições assimétricas têm a seguinte modulação: 120 (80 + 40), 140 (80 + 60), 160 (100 + 60), 180 (120 + 60), 200 (120 + 80). Outras configurações disponíveis.
- Móveis especiais: Para medidas intermediárias de largura e / ou altura, tome o preço da medida imediatamente superior.
- O gabinete de 35 alturas não possui sistema Decospace. Se a instalação permitir, pode ser encomendado sem custo adicional.

**& complementa**

COMPLEMENTA SEUS MÓVEIS  
Organizadores, toalheiros, ...  
página 148

- C Lavatório centrado
- D Lavatório direita
- I Lavatório esquerda
- X Lavatório duplo



## BASES DE BACIA SUSPENSAS

## 2 GAVETAS

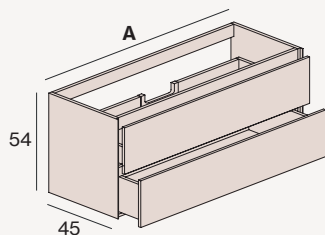

## 1 GAVETA + DECORATIVA

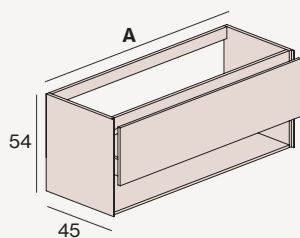

## 4 GAVETAS ASSIMÉTRICAS

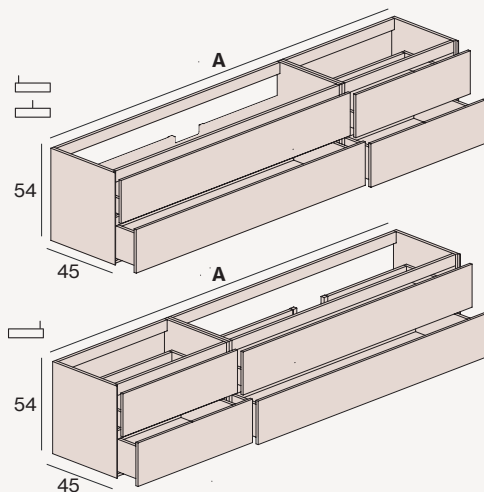

| A (cm)                            | LAVATÓRIO | REF        | LACA | PRANCHA MADEIRA MARINHA | MADEIRA SÓLIDA |
|-----------------------------------|-----------|------------|------|-------------------------|----------------|
| (apenas frente, estrutura lacada) |           |            |      |                         |                |
| 60                                |           | A202.060.C | -    | -                       | -              |
| 70                                |           | A202.070.C | -    | -                       | -              |
| 80                                |           | A202.080.C | -    | -                       | -              |
| 90                                |           | A202.090.C | -    | -                       | -              |
| 100                               |           | A202.100.I | -    | -                       | -              |
| 100                               |           | A202.100.C | -    | -                       | -              |
| 100                               |           | A202.100.D | -    | -                       | -              |
| 120                               |           | A202.120.I | -    | -                       | -              |
| 120                               |           | A202.120.C | -    | -                       | -              |
| 120                               |           | A202.120.D | -    | -                       | -              |
| 120                               |           | A202.120.X | -    | -                       | -              |
| 140                               |           | A202.140.I | -    | -                       | -              |
| 140                               |           | A202.140.C | -    | -                       | -              |
| 140                               |           | A202.140.D | -    | -                       | -              |
| 140                               |           | A202.140.X | -    | -                       | -              |

|     |  |            |   |   |   |
|-----|--|------------|---|---|---|
| 60  |  | A203.060.C | - | - | - |
| 70  |  | A203.070.C | - | - | - |
| 80  |  | A203.080.C | - | - | - |
| 90  |  | A203.090.C | - | - | - |
| 100 |  | A203.100.I | - | - | - |
| 100 |  | A203.100.C | - | - | - |
| 100 |  | A203.100.D | - | - | - |
| 120 |  | A203.120.I | - | - | - |
| 120 |  | A203.120.C | - | - | - |
| 120 |  | A203.120.D | - | - | - |
| 120 |  | A203.120.X | - | - | - |
| 140 |  | A203.140.I | - | - | - |
| 140 |  | A203.140.C | - | - | - |
| 140 |  | A203.140.D | - | - | - |
| 140 |  | A203.140.X | - | - | - |

|     |  |            |   |   |   |
|-----|--|------------|---|---|---|
| 120 |  | A208.120.I | - | - | - |
| 120 |  | A208.120.C | - | - | - |
| 120 |  | A208.120.D | - | - | - |
| 140 |  | A208.140.I | - | - | - |
| 140 |  | A208.140.C | - | - | - |
| 140 |  | A208.140.D | - | - | - |
| 160 |  | A208.160.I | - | - | - |
| 160 |  | A208.160.C | - | - | - |
| 160 |  | A208.160.D | - | - | - |
| 180 |  | A208.180.I | - | - | - |
| 180 |  | A208.180.C | - | - | - |
| 180 |  | A208.180.D | - | - | - |
| 200 |  | A208.200.I | - | - | - |
| 200 |  | A208.200.C | - | - | - |
| 200 |  | A208.200.D | - | - | - |



**& complementa**  
COMPLEMENTA  
SEUS MÓVEIS  
Organizadores, toalheiros, ...  
página 148

- C Lavatório centrado
- D Lavatório direita
- I Lavatório esquerda
- X Lavatório duplo

## BASES DE BACIA SUSPENSAS

## 4 GAVETAS SIMÉTRICAS

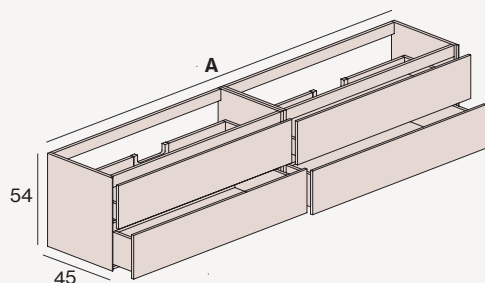

| A (cm)                            | LAVATÓRIO | REF        | LACA | PRANCHA MADEIRA MARINHA | MADEIRA SÓLIDA |
|-----------------------------------|-----------|------------|------|-------------------------|----------------|
| (apenas frente, estrutura lacada) |           |            |      |                         |                |
| 120                               |           | A209.120.I | -    | -                       | -              |
| 120                               |           | A209.120.D | -    | -                       | -              |
| 120                               |           | A209.120.X | -    | -                       | -              |
| 140                               |           | A209.140.I | -    | -                       | -              |
| 140                               |           | A209.140.D | -    | -                       | -              |
| 140                               |           | A209.140.X | -    | -                       | -              |
| 160                               |           | A209.160.I | -    | -                       | -              |
| 160                               |           | A209.160.D | -    | -                       | -              |
| 160                               |           | A209.160.X | -    | -                       | -              |
| 180                               |           | A209.180.I | -    | -                       | -              |
| 180                               |           | A209.180.D | -    | -                       | -              |
| 180                               |           | A209.180.X | -    | -                       | -              |
| 200                               |           | A209.200.I | -    | -                       | -              |
| 200                               |           | A209.200.D | -    | -                       | -              |
| 200                               |           | A209.200.X | -    | -                       | -              |

## MÓDULOS SUSPENSOS

## 1 GAVETA / BANCO

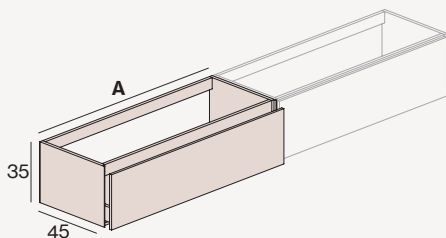

| A (cm)                            | REF        | LACA | PRANCHA MADEIRA MARINHA | MADEIRA SÓLIDA |
|-----------------------------------|------------|------|-------------------------|----------------|
| (apenas frente, estrutura lacada) |            |      |                         |                |
| 30                                | A101.030.M | -    | -                       | -              |
| 40                                | A101.040.M | -    | -                       | -              |
| 60                                | A101.060.M | -    | -                       | -              |
| 70                                | A101.070.M | -    | -                       | -              |
| 80                                | A101.080.M | -    | -                       | -              |
| 90                                | A101.090.M | -    | -                       | -              |
| 100                               | A101.100.M | -    | -                       | -              |
| 120                               | A101.120.M | -    | -                       | -              |
| 140                               | A101.140.M | -    | -                       | -              |

## 2 GAVETAS / BANCO

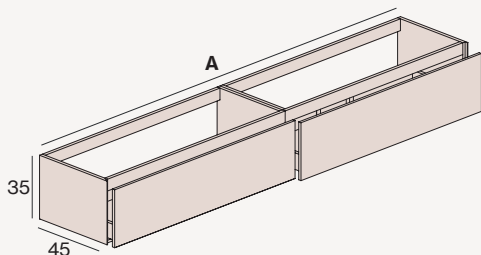

|     |            |   |   |   |
|-----|------------|---|---|---|
| 120 | A103.120.M | - | - | - |
| 140 | A103.140.M | - | - | - |
| 160 | A103.160.M | - | - | - |
| 180 | A103.180.M | - | - | - |
| 200 | A103.200.M | - | - | - |



· Você pode criar seu mobiliário personalizado adicionando os módulos à direita e / ou esquerda da base da bacia selecionada. Especifique sua posição.

**& complementa**  
 COMPLEMENTA  
 SEUS MÓVEIS  
 Organizadores, toalheiros, ...  
 página 148

C Lavatório centrado  
 D Lavatório direita  
 I Lavatório esquerda  
 X Lavatório duplo

## MÓDULOS SUSPENSOS

## DECORATIVO

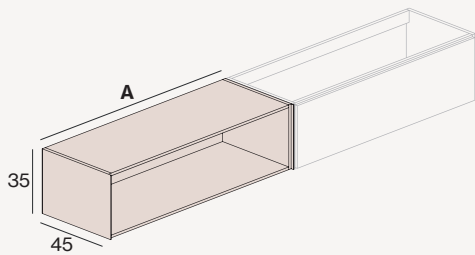

| A (cm) | REF        | LACA |
|--------|------------|------|
| 30     | A104.030.M | -    |
| 40     | A104.040.M | -    |
| 60     | A104.060.M | -    |
| 70     | A104.070.M | -    |
| 80     | A104.080.M | -    |

## 2 PRATELEIRAS DECORATIVAS

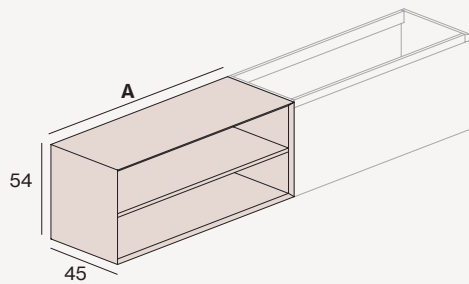

|    |            |   |
|----|------------|---|
| 30 | A207.030.M | - |
| 40 | A207.040.M | - |
| 60 | A207.060.M | - |
| 70 | A207.070.M | - |
| 80 | A207.080.M | - |

## 2 GAVETAS

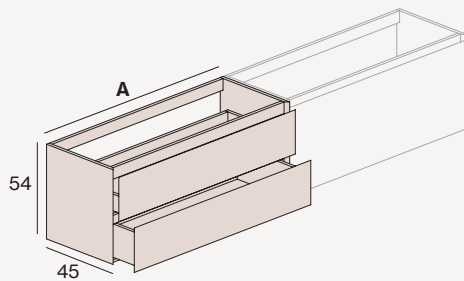

| A (cm)                            | REF        | LACA | PRANCHA MADEIRA MARINHA | MADEIRA SÓLIDA |
|-----------------------------------|------------|------|-------------------------|----------------|
| (apenas frente, estrutura lacada) |            |      |                         |                |
| 30                                | A201.030.M | -    | -                       | -              |
| 40                                | A201.040.M | -    | -                       | -              |
| 60                                | A201.060.M | -    | -                       | -              |
| 70                                | A201.070.M | -    | -                       | -              |
| 80                                | A201.080.M | -    | -                       | -              |
| 90                                | A201.090.M | -    | -                       | -              |
| 100                               | A201.100.M | -    | -                       | -              |
| 120                               | A201.120.M | -    | -                       | -              |
| 140                               | A201.140.M | -    | -                       | -              |

## 1 GAVETA + DECORATIVA

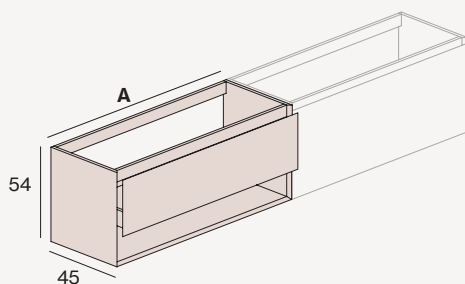

|     |            |   |   |   |
|-----|------------|---|---|---|
| 30  | A203.030.M | - | - | - |
| 40  | A203.040.M | - | - | - |
| 60  | A203.060.M | - | - | - |
| 70  | A203.070.M | - | - | - |
| 80  | A203.080.M | - | - | - |
| 90  | A203.090.M | - | - | - |
| 100 | A203.100.M | - | - | - |
| 120 | A203.120.M | - | - | - |
| 140 | A203.140.M | - | - | - |



· Você pode criar seu mobiliário personalizado adicionando os módulos à direita e / ou esquerda da base da bacia selecionada. Especifique sua posição.

**& complementa**  
COMPLEMENTA  
SEUS MÓVEIS  
Organizadores, toalheiros, ...  
página 148



# Acessórios **Atelier**

|                    |     |
|--------------------|-----|
| Interior de móveis | 150 |
| Pé do móveis       | 151 |
| Exterior de móveis | 152 |

### MÓVEIS INTERIORES

#### ORGADRAW

Conjunto de organizadores.



Antracite



REF

PVP

CM1

-

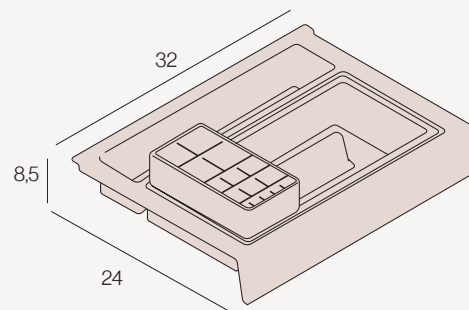

#### ORGASTRIP

Sistema de divisão guiada por trilho para gaveta superior.

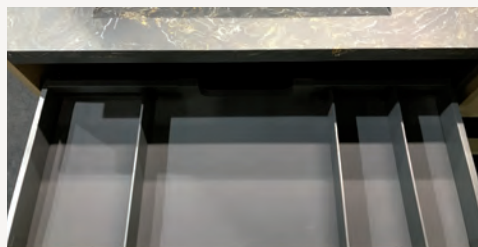

Antracite

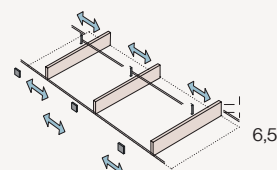

| A   | REF     | SEPARADORES | PVP |
|-----|---------|-------------|-----|
| 30  | CM2.030 | 1           | -   |
| 40  | CM2.040 | 1           | -   |
| 60  | CM2.060 | 2           | -   |
| 70  | CM2.070 | 2           | -   |
| 80  | CM2.080 | 3           | -   |
| 90  | CM2.090 | 3           | -   |
| 100 | CM2.100 | 4           | -   |
| 120 | CM2.120 | 4           | -   |
| 140 | CM2.140 | 4           | -   |

#### Separador adicional

|  |         |   |   |
|--|---------|---|---|
|  | CM2.010 | 1 | - |
|--|---------|---|---|

#### PROTEÇÃO DE GAVETA

Folha de proteção antiderrapante para gaveta.



Cores

Pérola



Telha



| A   | PÉROLA  |     | TELHA   |     |
|-----|---------|-----|---------|-----|
|     | REF     | PVP | REF     | PVP |
| 30  | CM3.030 | -   | CM4.030 | -   |
| 40  | CM3.040 | -   | CM4.040 | -   |
| 60  | CM3.060 | -   | CM4.060 | -   |
| 70  | CM3.070 | -   | CM4.070 | -   |
| 80  | CM3.080 | -   | CM4.080 | -   |
| 90  | CM3.090 | -   | CM4.090 | -   |
| 100 | CM3.100 | -   | CM4.100 | -   |
| 120 | CM3.120 | -   | CM4.120 | -   |
| 140 | CM3.140 | -   | CM4.140 | -   |

### PERNAS PARA MÓVEIS

#### ESTRUTURA METÁLICA PARA MÓVEIS H54

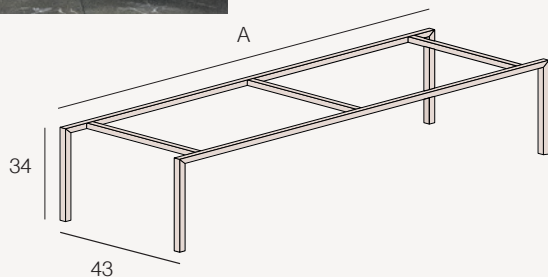

| A   | REF     | PRETO | COR |
|-----|---------|-------|-----|
| 60  | CM5.060 | -     | -   |
| 70  | CM5.070 | -     | -   |
| 80  | CM5.080 | -     | -   |
| 90  | CM5.090 | -     | -   |
| 100 | CM5.100 | -     | -   |
| 120 | CM5.120 | -     | -   |
| 140 | CM5.140 | -     | -   |
| 160 | CM5.160 | -     | -   |
| 180 | CM5.180 | -     | -   |
| 200 | CM5.200 | -     | -   |

A medida da parte inferior da estrutura é cerca de 2 centímetros mais baixa que a parte inferior do gabinete para não interferir nas frentes.

#### Cores



#### PATAS H3

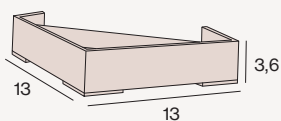

Cromada  
brilho

#### REF

#### PVP

CM6

-

Conjunto de 4 unidades

#### PATASH7

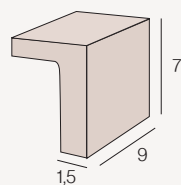

Cromada  
brilho

#### REF

#### PVP

CM7

-

Conjunto de 4 unidades

### MÓVEIS EXTERIORES

#### TOALHA LATERAL

Porta-toalhas cromado brilhante para ser colocado na lateral do gabinete.

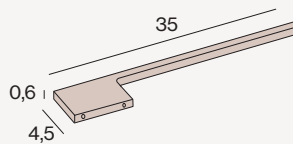

#### COR

#### REF

#### PVP

|                  |        |   |
|------------------|--------|---|
| Cromada brilho   | CM8.CB | - |
| Preto mate       | CM8.BK | - |
| Cor (carta laca) | CM8.CO | - |

#### Cores



#### TOALHA

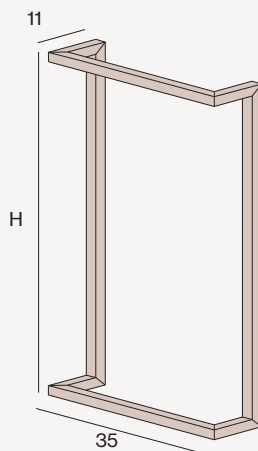

#### H

#### COR

#### REF

#### PVP

|    |                  |           |   |
|----|------------------|-----------|---|
| 75 | Preto mate       | CM9.75.BK | - |
| 75 | Cor (carta laca) | CM9.75.CO | - |
| 85 | Preto mate       | CM9.85.BK | - |
| 85 | Cor (carta laca) | CM9.85.CO | - |

Gabinete H = 85 cm com pia integrado.

Gabinete H = 75 cm com pia do fogão.

#### Cores





### MÓVEIS EXTERIORES

#### LUZ DE FUNDO INFERIOR

Iluminação sob a mobília, sob o teto falso, móvel de parede ou coluna.

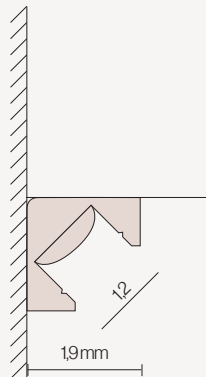

| LUZ | COR °K           | CONSUMO | POTÊNCIA                  | ESTADO | DRIVER   | MATERIAL |
|-----|------------------|---------|---------------------------|--------|----------|----------|
| LED | 4000°K<br>Neutro | 4,8W    | 400 LÚMEN<br>metro linear | IP67   | INCLUÍDO | ALUMÍNIO |

Personaliza teu LED em 3000°K ou 4200°K sem cargo. Standard de 5500°K.

#### AJUSTE DA PAREDE

Tira de ajuste entre as paredes.



| A   | REF      | PVP |
|-----|----------|-----|
| 60  | CM10.060 | -   |
| 70  | CM10.070 | -   |
| 80  | CM10.080 | -   |
| 90  | CM10.090 | -   |
| 100 | CM10.100 | -   |
| 120 | CM10.120 | -   |
| 140 | CM10.140 | -   |
| 160 | CM10.160 | -   |
| 180 | CM10.180 | -   |
| 200 | CM10.200 | -   |

A medida real da iluminação LED é 4 centímetros menor que a largura do gabinete para que não sejam vistos de lado.

| H  | REF     | LACA | PRANCHA MADEIRA MARINHA |
|----|---------|------|-------------------------|
| 27 | CM15.27 | -    | -                       |
| 35 | CM15.35 | -    | -                       |
| 54 | CM15.54 | -    | -                       |
| 81 | CM15.81 | -    | -                       |

X a ser definido conforme necessário.



# 02

## Casual

### Móveis de casa de banho

A tendência, o frescor, o cotidiano.

# Play

Liberdade para compor,  
modular, colorir cada projeto.





▲ Banho  
*Orion Solid Surface*

Auxiliar  
*Prateleiras duplas de metal  
prateleira*



339



333



Peça de mobiliário  
*2 baús mais gaveta interna /  
Frente puxador Glass*



Bancada  
*Integrado com saia  
Negro Marquina*



Espelho enquadrado  
*Metal quadrado com  
espelho aumento móvel*



Luz decorativa  
*Ledarc*





◀ Detalhe frontal vidro com perfil metálico e extrator Integrado com vidro texturizado na cor do cartão lacado.







▼ Espelho enquadrado  
*Metalsquare*

Luz pendente  
*Ledarc*

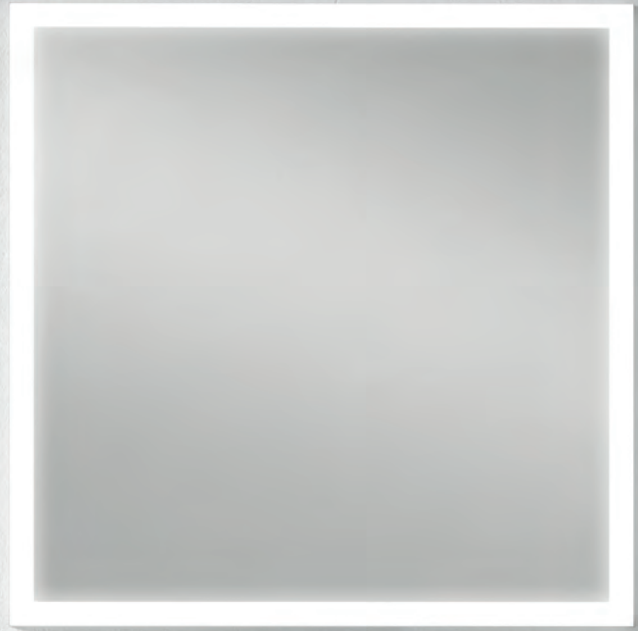







◀ Peça de mobiliário  
1 baú com vidro interior /  
gaveta frontal  239

Bancada  
Ceramcolor plana  290  
Lavatório Ceramcolor  
Circus

Espelho  
retroiluminado  304  
Fronled

Auxiliar  335  
Banco de metal  
com sobre lacado





- ▲ Lavatório de cerâmica colorida com a mesma cor do móvel disponível em até 8 cores

- ◀ Armário frontal de vidro envernizado texturizado mesma cor que móveis em 18 cores acessível

- ▼ Banco auxiliar







◀ **Peça de mobiliário**  
*4 gavetas / puxador Incolor  
acabamento lacado  
Estrutura metálica de  
pernas decorativas*



241

**Bancada**  
*Solid Surface plana  
Lavatório de mesa Cuadro  
de Solid Surface*



289

**Espelho enquadrado**  
*Corner personalizado*



308

**Luz decorativa**  
*Ledcirc*



321

**Auxiliar**  
*Armário auxiliar duas  
portas e decorativo*



331

**Banho**  
*Borealis Solid Surface*



338

Detalhe interior do móvel. ►  
Gavetas de metal 4D de  
extração total e travagem  
silenciosa. A gaveta de cima do  
lavatório com sifão distribuidor

▼ Espelho de canto de esquadria lacado









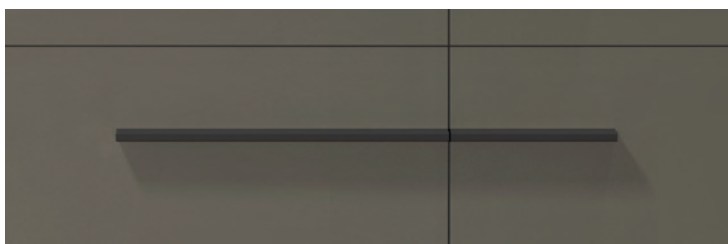
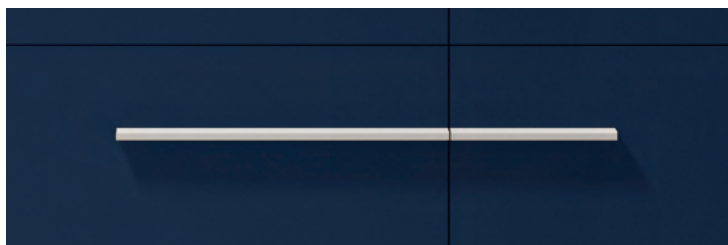
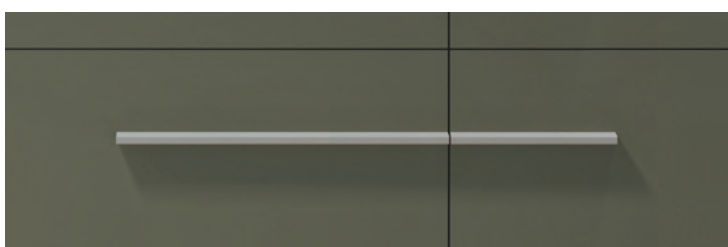





◀ Personalize o seu gabinete Incolor com qualquer um de 18 cores do gráfico de laca ambos os móveis como en o cabo de alumínio lacado epóxi





- ◀ Peça de mobiliário  
*2 gavetas + oco*  
*cabo decorativo / puxador Incolor*  241
  
- Bancada  
*plana Solid Mineral*  
*Lavatório de bancada Smile*  288
  
- Espelho liso  
*Round liso*  300
  
- Auxiliar  
*Prateleira Complet de madeira*  
*toalheiro de parede de metal*  332  
 334



239

Gabinete frontal ▶  
*2 gavetas lacadas / puxador Black*  
*Porta toalha metálico*  
*com pés*



306

Espelho enquadrado  
*Metalsquareled*



321

Luz decorativa  
*Ledcirc*



330

Auxiliares



335

*Vitrine guarda-roupa 2 portas*  
*Banco auxiliar*





Peça de mobiliário

Banco de 2 gavetas e módulo  
de 1 gaveta Madeira Nature / puxador Negro

Bancada

Plana com saia de Madeira Nature  
lavatório natural Ceramcolor Circus

Espelho enquadrado  
Metalrounded







320

Luz decorativa  
*Ledpoint*



332

Auxiliar  
*Prateleira decorativa completado*



339

Banho  
*Orion Solid Surface*



02 CASUAL  
MÓVEIS DE CASA DE BANHO



▲ Detalhe de alça preta



◀ Luz decorativa  
*Ledpoint*

Auxiliar  
*Prateleira decorativa*  
*Completo*



▲ Espelhos com moldura de metal  
com led integrado





▲ Auxiliar  
*Coluna decorativa*



329



Peça de mobiliário  
2 gavetas lacadas / puxador Curve  
Módulo lateral decorativo



Bancada integrada  
Mural Pizarra



Espelho  
Eyeled



Auxiliar  
Gabinete auxiliar com  
2 portas decorativas





◀ Espelho retroiluminado frontal Eyeled



▲ Detalhe do módulo decorativo lateral

 338

Banho ▶  
*Leo Solid Surface*







Peça de mobiliário  
2 gavetas e 1 gaveta com furo  
decorativo / puxador Lineal lacado



239

Bancada  
Carvalho maciço plano  
lavatório de bancada de vidro



287

Espelho retroiluminado ▲  
Circled



321



▲ Topo plano de carvalho maciço



▲ Detalhe de alça fresada Lineal

 238 **Peça de mobiliário** ▶  
*Banco lacado 2 gavetas /  
puxador de Inglete*

 268 **Bancadas**  
*Parede integrada*  
*Solid Mineral personalizado*  
*Solid Mineral topo plano*  
*sob medida*

 302 **Espelho retroiluminado**  
*Filed*

 321 **Luz decorativa**  
*Circled*

 328 **Auxiliar**  
*Coluna duas portas*  
*envernizado*





Auxiliares ►  
*Coluna de 2 portas / puxador Push /  
banco auxiliar*

Banho  
*Leo Solid Surface*







▲ Detalhe do cabo da esquadria 45°









- ◀ Peça de mobiliário  
*1 gaveta / moldura lateral  
lacada e frente em Madeira  
Nature / puxador Rail /  
toalheiro lateral lacado*  238
  
- Bancada integrada  
*Padrão de Solid Mineral*  264
  
- Espelho  
*Suave com LED 5X*  300-310
  
- Auxiliar  
*Toalheiro na parede  
Lacado*  334
  
- Iluminação  
*Aplique Ledin*  318



▲ Banho  
*Borealis Solid Surface*

Luz decorativa  
*Ledpoint*





Peça de mobiliário  
2 gavetas e 1 porta / moldura  
lateral em Madeira Nature e frente  
lacada / puxador Neo



Bancada integrada  
Solid Mineral deslocado  
deixou



Espelho retroiluminado  
Circled



Auxiliar  
Armário de 1 porta  
porta-toalhas de pé  
independente





◀ Toalheiro de chão metal. Disponível em cores lacadas



◀ Detalhe da gaveta  
topo com distribuidor



◀ Detalhe do  
puxador Neo



239



243



284



300



328



339



319

Peça de mobiliário ▶

2 gavetas + estrutura metálica  
Madeira Nature / puxador Push

Bancada

Madeira Nature pia de  
bancada plana  
Ceramcolor

Espelho

Liso garantido sob medida

Auxiliares

Composição formada por  
coluna de 2 portas e 1 coluna  
de porta envernizado

Banho

Leo Solid Surface

Iluminação

Aplicação para espelho Ledbar











- ▲ As estruturas metálicas podem ser personalizadas em qualquer uma das cores da cartela de laca

Peça de mobiliário  
2 baús / puxador Line

Bancada plana  
Envernizada / bacia Solid Mineral

Espelho Retroiluminado  
Spinled





332



334

Auxiliar  
*Prateleira decorativa Completa*  
*Toalheiro de parede de metal*  
*Roupeiro lacado 2 portas*  
*Prateleira dupla de metal*



328



334







339

Banho  
*Leo Solid Surface*







- ◀ Peça de mobiliário  
*1 gaveta e 1 baú / puxador Line  
com acabamento lacado*  242
  
- Bancada plana  
*Solid Mineral*  288
  
- Lavatório  
*Toten de Solid Mineral*  283
  
- Espelho retroiluminado  
*Spined*  303



◀ Peça de mobiliário  
1 gaveta e 1 baú / puxador  
Line com acabamento lacado

Bancada  
Solid Mineral

Lavatório ▶  
Totem de Solid Surface  
Espelho retroiluminado  
Spinled





- ▲ Peça de mobiliário  
1 moldura de gaveta / puxador Frame  
com acabamento lacado  
Estrutura metálica com pés decorativos  
com prateleira de vidro fumê

 238

 243

- Bancada integrada  
Solid Mineral

 264

- Espelho liso  
Espelho com luz de parede  
Ledbar

 300

 319





Luz decorativa  
*Ledcirc*



321

Banho  
*Leo Solid Surface*



339

▼ Detalhe do quadro frontal



Banho ►  
Solid Surface  
Luz decorativa  
Ledcirc



▲ Estrutura  
*Detalhe estrutura metálica com vidro fumê*





▲ Peça de mobiliário  
Estrutura metálica de  
pernas com prateleira  
de vidro fumê e toalheiro

Bancada integrada  
*Solid Mineral Thin*

Espelho retroiluminado  
*Rounded*



▲ Banho  
*Borealis Solid Surface*

Auxiliar  
*Toalheiro de pé de metal*



# Step

O concreto, na hora certa.

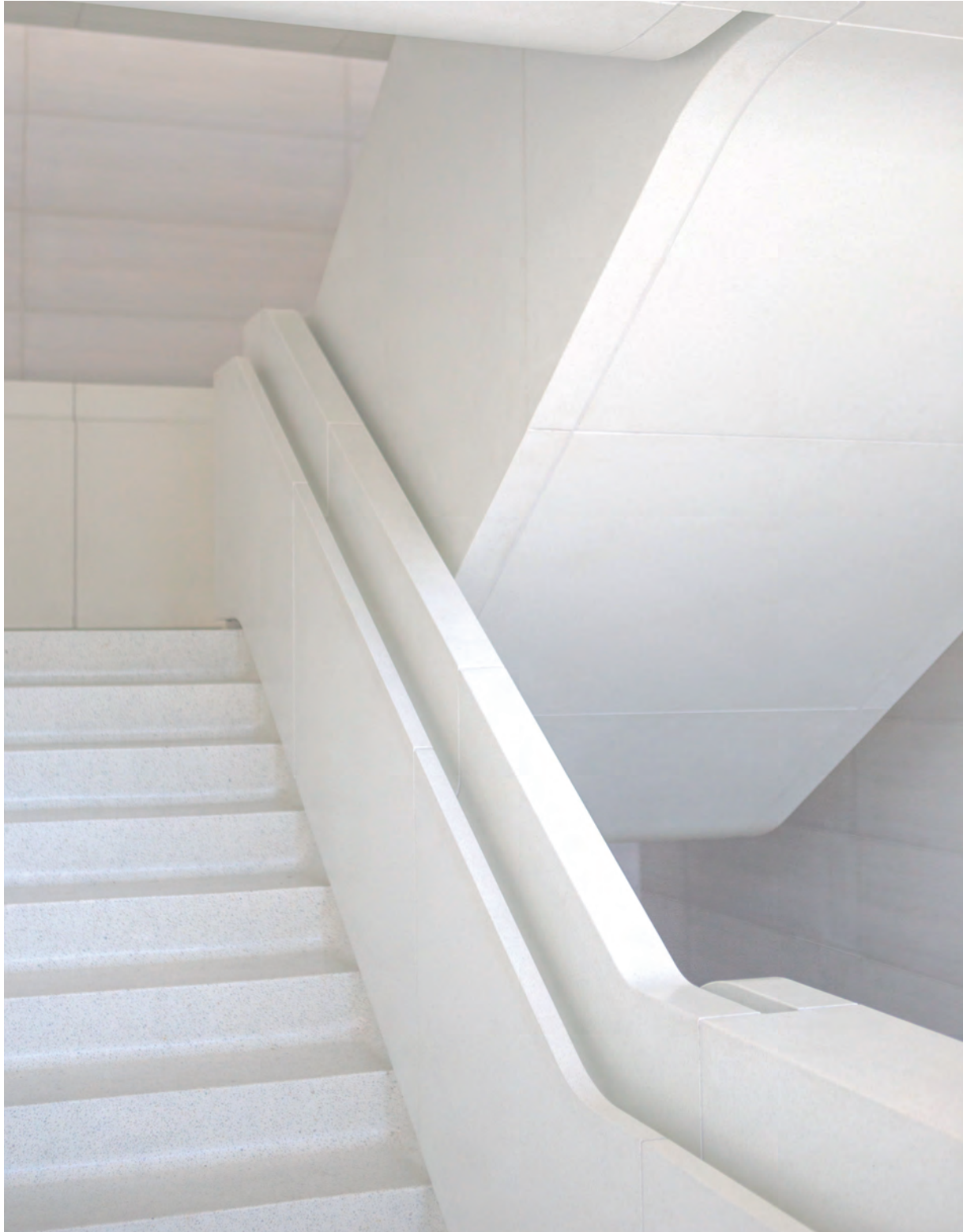

Banho  
▼ *Borealis Solid Surface*

Auxiliar  
*Toalheiro de parede de metal*







256

Peça de mobiliário  
2 gavetas / puxador *Inglete*  
*Step* acabamento lacado



262

Bancada integrada  
*Cerâmica*



301

Espelho retroiluminado  
*Rounded*



02 CASUAL  
MÓVEIS DE CASA DE BANHO

Detalhe frontal ►  
Inglete







256

Peça de mobiliário ▶  
2 gavetas / puxador Step  
com acabamento em  
laminado Sand



264

Bancada Integrada  
Solid Mineral



303

Espelho retroiluminado  
Spined



335

Auxiliar  
Suporte de toalheiro de metal



338

Banho  
Andromeda Solid Surface







▲ Coleção Step de detalhes de textura laminada





- ▲ Peça de mobiliário  
2 gavetas / puxador Inglete  
Step acabamento lacado Branco  
Mate



- Bancada Integrada  
Solid Mineral Hard de seio  
duplo



- Espelho liso  
Liso / aplique Ledin







Auxiliar  
*Toalheiro de parede de metal*

Auxiliar ▶  
*Toalheiro de parede de metal*





▲ Detalhe interior das gavetas



STEP



# 02

## Informação técnica e tarifa

# Casual

DECOSAN

Bath design

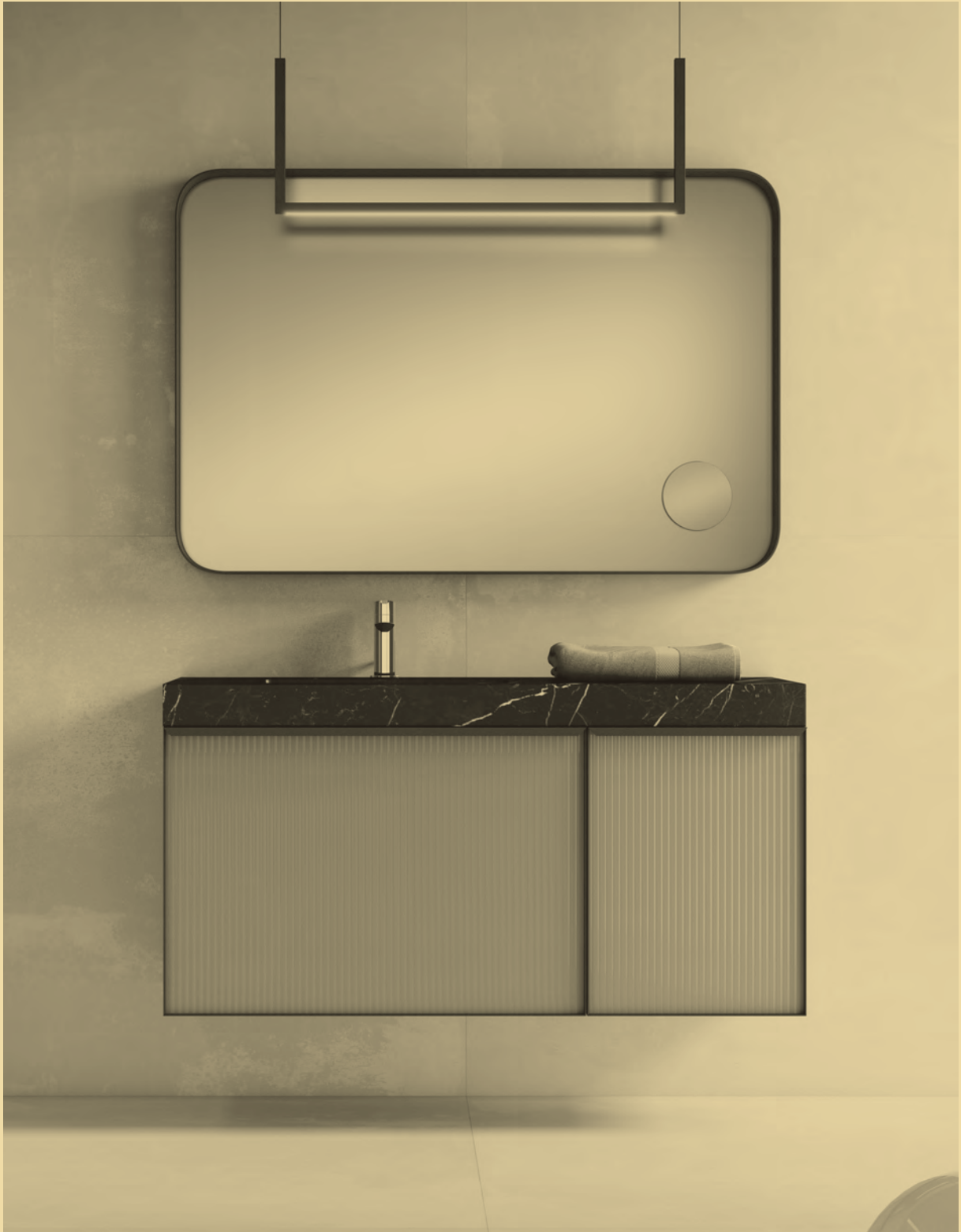

# Play

|                              |     |
|------------------------------|-----|
| Recursos e equipamentos      | 232 |
| Personalize seus móveis Play | 233 |
| Bases de lavatório suspensas | 238 |
| Formulários suspenso         | 244 |
| Play - Complementa           | 248 |



#### 4D GAVETAS

Gavetas Hettich ou Blum em metal antracite e perfil extrafino de 12 mm com 4 regulagens. Os guias possuem extensão total e sistema de frenagem progressiva.



#### SOB MEDIDA

Esta coleção permite a fabricação sob medida. No caso de medidas intermediárias de altura e largura, calcule o preço da próxima medida superior.



#### ANTRACITE FULLCOLOR

Conceito de design de interiores onde todos os materiais do interior do móvel são desenhados em antracite. O gabinete com acabamento lacado é lacado internamente em antracite.



#### DURALACK SYSTEM

As cores lacadas contêm aditivos de endurecimento que permitem que o acabamento final seja altamente resistente a fricção e abrasão.



#### PUSH AND SLOW

As gavetas com sistema de abertura Push sem puxadores possuem um sistema de sincronização que permite a sua abertura pressionando em qualquer parte da frente. Ao mesmo tempo, o fechamento é progressivo e silencioso.



#### DECOFIX SYSTEM

Sistema de fixação de parede de alta segurança com o qual as resistências de carga são mais de 240 kg.



#### DECOBUILD SYSTEM

Móveis feitos com placas de 19 mm colados com cutelos obtendo uma estética limpa sem encaixes visíveis e oferecendo maior resistência e durabilidade.



O Play permite que você personalize facilmente seus móveis

Escolha o puxador, a cor e a estrutura do móvel em apenas três etapas

- 1 Escolha sua alça e especifique a cor desejada
  - 1.1 Escolha o seu cabo laqueado
  - 1.2 Escolha o seu cabo de madeira
- 2 Escolha a estrutura do móvel

**1.1** Escolha o seu puxador Acabamento lacado

**Black**

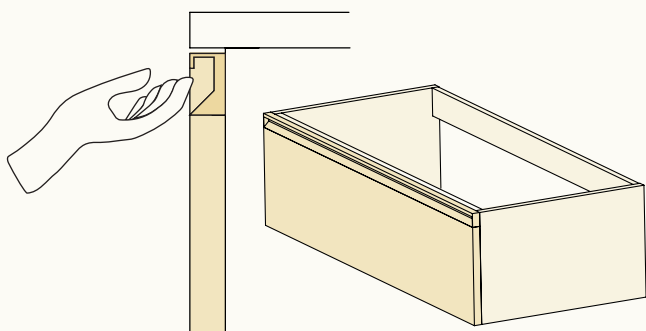

**Curve**

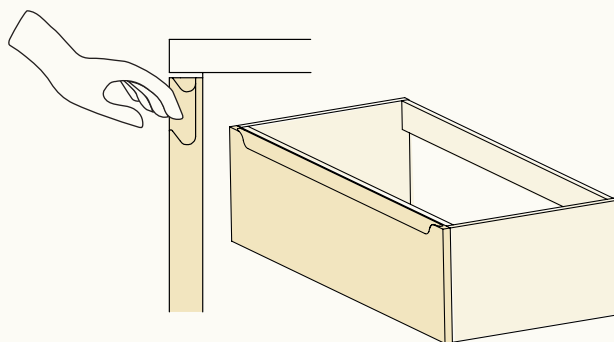

**Incolor**

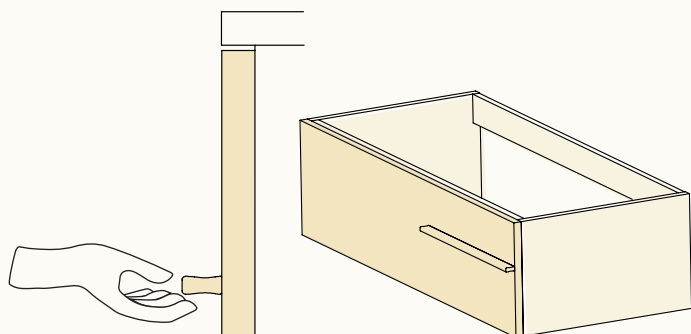

**Lineal**

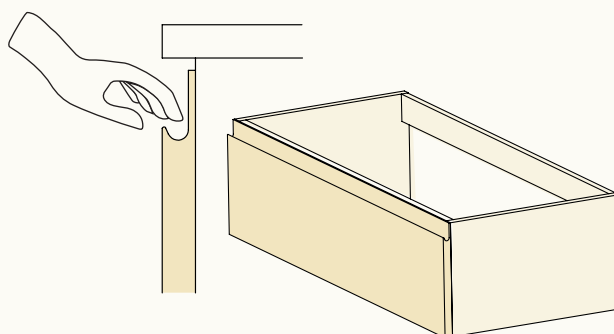

Você pode escolher o puxador diferente da cor do móvel

**Inglete**

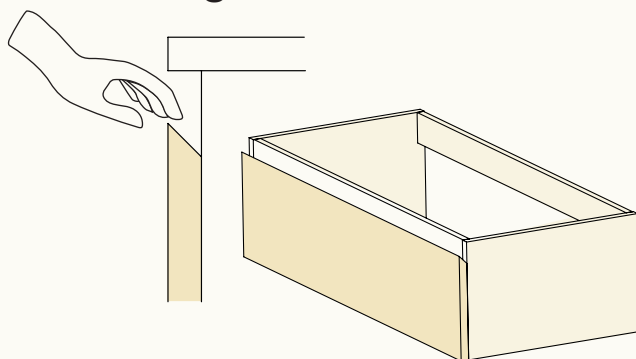

**Rail**

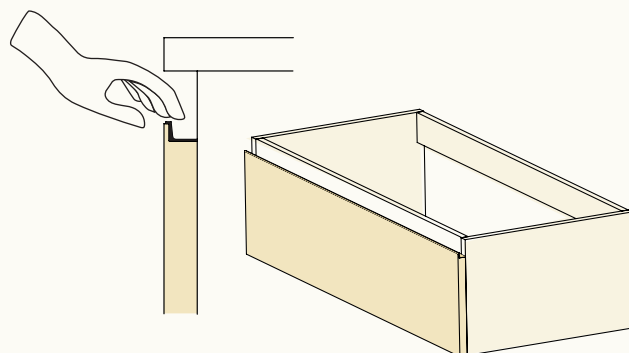

Perfil metálico de alumínio acetinado

Blanco Mate  
Blanco Brilho

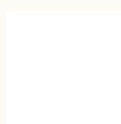

Negro Mate  
Negro Brilho



Beige Mate  
Beige Brilho



Tierra Mate  
Tierra Brilho



Caqui Mate  
Caqui Brilho



Cuarzo Mate  
Cuarzo Brilho



Moka Mate  
Moka Brilho



Perla Mate  
Perla Brilho



Piedra Mate  
Piedra Brilho



**Neo**

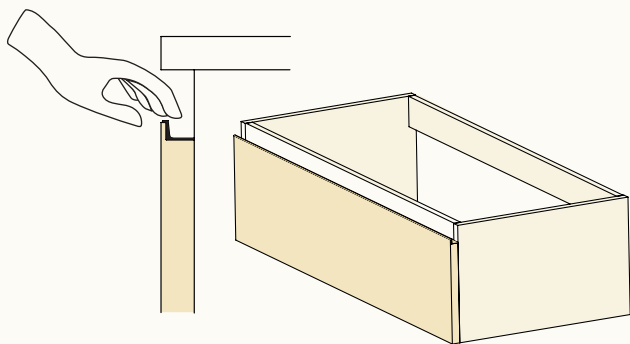

Perfil de metal preto mate

**Push**

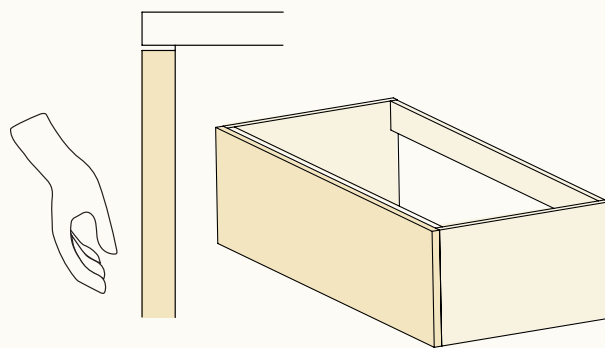

**Line**

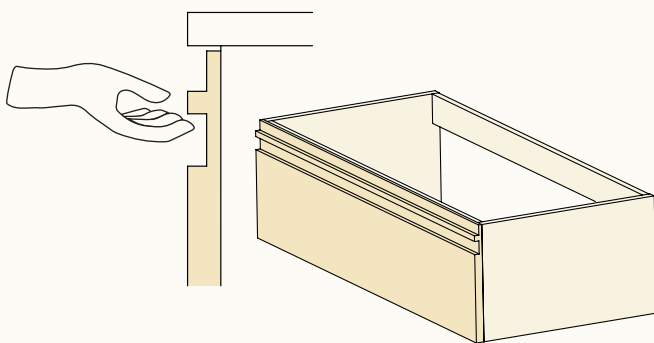

**Frame**

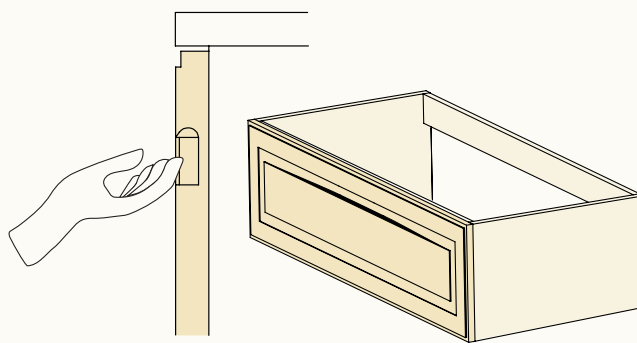

**Glass**

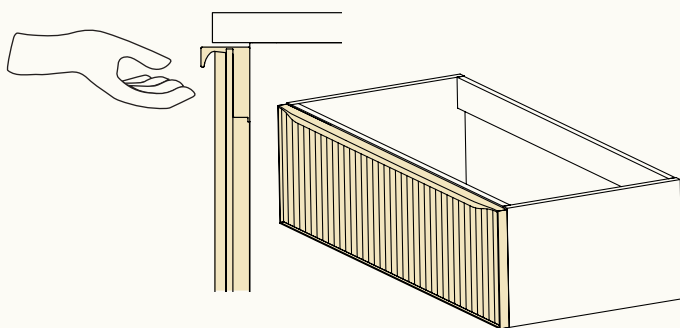

Perfil preto  
Você pode escolher a cor do vidro diferente da cor dos móveis

 **Cor RAL ou NCS**

RAL / NCS Mate 50 €  
RAL / NCS Brilho 50 €

Acero Mate  
Acero Brilho

Antracita Mate  
Antracita Brilho

Burdeos Mate  
Burdeos Brilho

Océano Mate  
Océano Brilho

Menta Mate  
Menta Brilho

Oliva Mate  
Oliva Brilho

Terracota Mate  
Terracota Brilho

Albero Mate  
Albero Brilho

Rosa Mate  
Rosa Brilho



1.2 Escolha o seu puxador de madeira Acabado Madeira Nature

**Black**

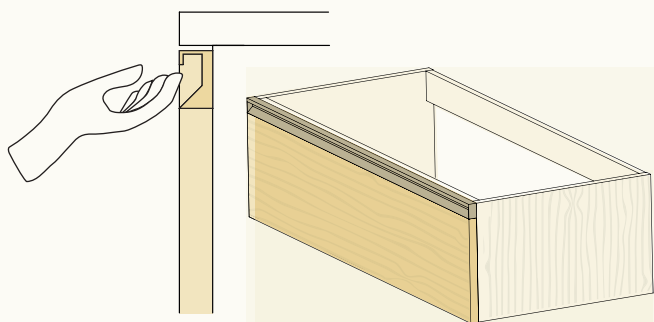

**Push**

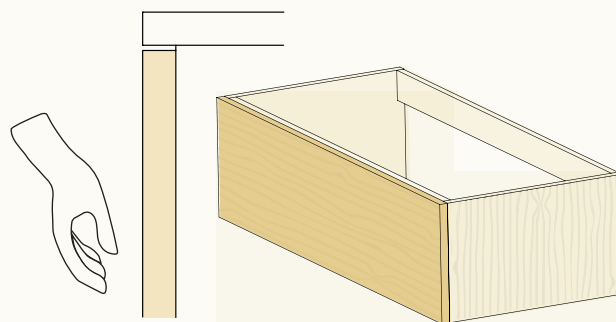

**Incolor**

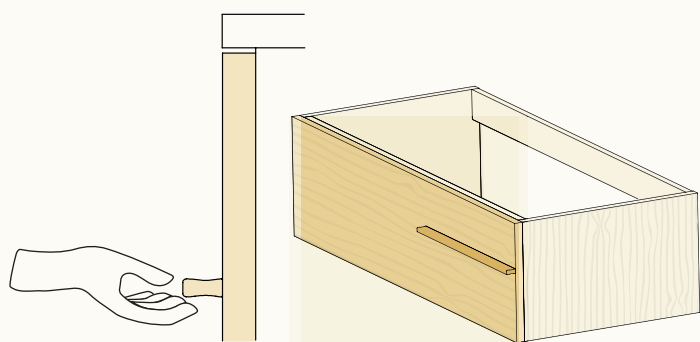

Escolha a cor do puxador (lacado brilho ou mate)

**Rail**

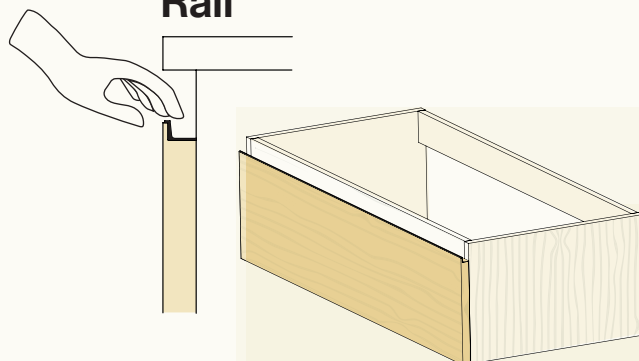

Perfil metálico de alumínio acetinado

**Neo**

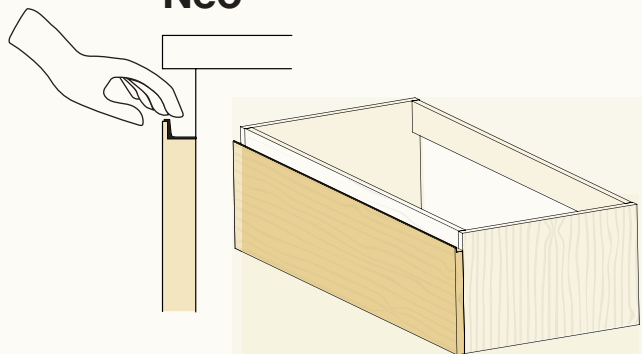

Perfil metálico preto mate

Carbon



Brown

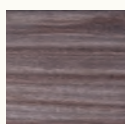

Artic

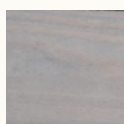

Cocoa

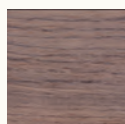

Camel

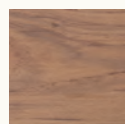

Savana

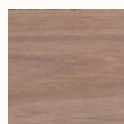

Nogueira

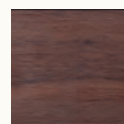

## 2 Escolha a estrutura do móvel

Em todos os layouts Play, você pode escolher duas opções de estrutura.

### Frente

A puxador se sobrepõe à estrutura do móvel.

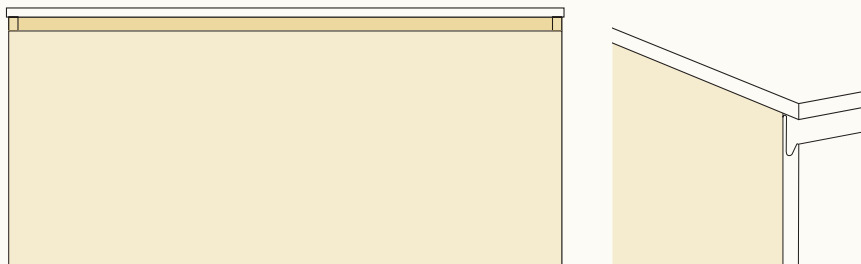

### Lado

As laterais do gabinete são vistas como um terminal decorativo.

- Particularmente recomendado nos casos em que o móvel é fixado à parede.
- No caso de demodulação de várias bases, apenas as extremidades da composição serão visíveis.

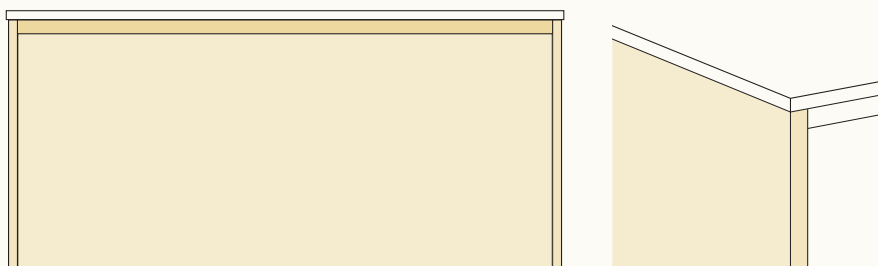

Como padrão, a cor da estrutura é igual à cor do cabo.

Se desejar, você pode escolher a cor da estrutura diferente da cor do cabo. Especificamos.

|                              |                                    |                                |                              |                            |                              |                                    |                              |                              |
|------------------------------|------------------------------------|--------------------------------|------------------------------|----------------------------|------------------------------|------------------------------------|------------------------------|------------------------------|
| Blanco Mate<br>Blanco Brilho | Negro Mate<br>Negro Brilho         | Beige Mate<br>Beige Brilho     | Tierra Mate<br>Tierra Brilho | Caqui Mate<br>Caqui Brilho | Cuarzo Mate<br>Cuarzo Brilho | Moka Mate<br>Moka Brilho           | Perla Mate<br>Perla Brilho   | Piedra Mate<br>Piedra Brilho |
| Acero Mate<br>Acero Brilho   | Antracita Mate<br>Antracita Brilho | Burdeos Mate<br>Burdeos Brilho | Océano Mate<br>Océano Brilho | Menta Mate<br>Menta Brilho | Oliva Mate<br>Oliva Brilho   | Terracota Mate<br>Terracota Brilho | Albero Mate<br>Albero Brilho | Rosa Mate<br>Rosa Brilho     |
| Carbon                       | Brown                              | Artic                          | Cocoa                        | Camel                      | Savana                       | Nogueira                           |                              |                              |

### BASES PARA LAVATÓRIO PENDURADO NA PAREDE

#### 1 GAVETA

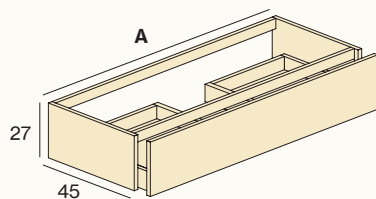

| A (cm) | LAVATÓRIO | REF        | MADEIRA NATURE         |      | LACA  |                       |
|--------|-----------|------------|------------------------|------|---|-----------------------|
|        |           |            | BLACK-INCOLOR-NEO-RAIL | PUSH | BLACK-CURVE-LINEAL-INCOLOR-INGLETE-NEO-RAIL | LINE-GLASS-FRAME-PUSH |
| 60     |           | P101.060.C | -                      | -    | -   | -                     |
| 70     |           | P101.070.C | -                      | -    | -   | -                     |
| 80     |           | P101.080.C | -                      | -    | -   | -                     |
| 90     |           | P101.090.C | -                      | -    | -   | -                     |
| 100    |           | P101.100.I | -                      | -    | -   | -                     |
| 100    |           | P101.100.C | -                      | -    | -   | -                     |
| 100    |           | P101.100.D | -                      | -    | -   | -                     |
| 120    |           | P101.120.I | -                      | -    | -   | -                     |
| 120    |           | P101.120.C | -                      | -    | -   | -                     |
| 120    |           | P101.120.D | -                      | -    | -   | -                     |
| 120    |           | P101.120.X | -                      | -    | -   | -                     |
| 140    |           | P101.140.I | -                      | -    | -   | -                     |
| 140    |           | P101.140.C | -                      | -    | -   | -                     |
| 140    |           | P101.140.D | -                      | -    | -   | -                     |
| 140    |           | P101.140.X | -                      | -    | -   | -                     |

#### 2 GAVETAS ASSIMÉTRICAS

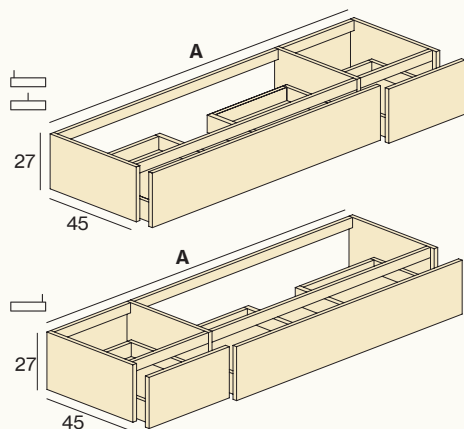

|     |  |            |   |   |   |   |
|-----|--|------------|---|---|---|---|
| 120 |  | P102.120.I | - | - | - | - |
| 120 |  | P102.120.C | - | - | - | - |
| 120 |  | P102.120.D | - | - | - | - |
| 140 |  | P102.140.I | - | - | - | - |
| 140 |  | P102.140.C | - | - | - | - |
| 140 |  | P102.140.D | - | - | - | - |
| 160 |  | P102.160.I | - | - | - | - |
| 160 |  | P102.160.C | - | - | - | - |
| 160 |  | P102.160.D | - | - | - | - |
| 180 |  | P102.180.I | - | - | - | - |
| 180 |  | P102.180.C | - | - | - | - |
| 180 |  | P102.180.D | - | - | - | - |
| 200 |  | P102.200.I | - | - | - | - |
| 200 |  | P102.200.C | - | - | - | - |
| 200 |  | P102.200.D | - | - | - | - |

#### 2 GAVETAS SIMÉTRICAS

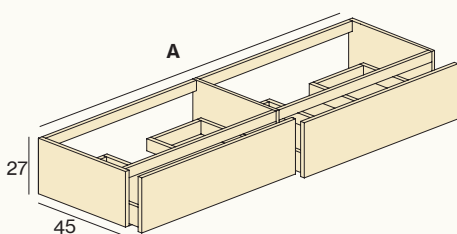

|     |  |            |   |   |   |   |
|-----|--|------------|---|---|---|---|
| 120 |  | P103.120.I | - | - | - | - |
| 120 |  | P103.120.D | - | - | - | - |
| 120 |  | P103.120.X | - | - | - | - |
| 140 |  | P103.140.I | - | - | - | - |
| 140 |  | P103.140.D | - | - | - | - |
| 140 |  | P103.140.X | - | - | - | - |
| 160 |  | P103.160.I | - | - | - | - |
| 160 |  | P103.160.D | - | - | - | - |
| 160 |  | P103.160.X | - | - | - | - |
| 180 |  | P103.180.I | - | - | - | - |
| 180 |  | P103.180.D | - | - | - | - |
| 180 |  | P103.180.X | - | - | - | - |
| 200 |  | P103.200.I | - | - | - | - |
| 200 |  | P103.200.D | - | - | - | - |
| 200 |  | P103.200.X | - | - | - | - |



- As composições assimétricas têm a seguinte modulação: 120 (80 + 40), 140 (80 + 60), 160 (100 + 60), 180 (120 + 60), 200 (120 + 80). Outras configurações disponíveis
- Móveis especiais: para medidas intermediárias de largura e / ou altura, tome o preço da medida imediatamente superior.

#### & complementa

Organizadores, pés, toalheiros, retroiluminação página....248

- C Lavatório centrado
- D Lavatório direita
- I Lavatório esquerda
- X Lavatório duplo

BASES PARA LAVATÓRIO PENDURADO NA PAREDE

2 GAVETAS

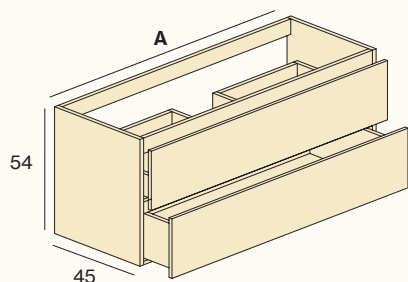

| A (cm) | LAVATÓRIO | REF        | MADEIRA NATURE         |      | LACA  |                       |
|--------|-----------|------------|------------------------|------|---|-----------------------|
|        |           |            | BLACK-INCOLOR-NEO-RAIL | PUSH | BLACK-CURVE-LINEAL-INCOLOR-INGLETE-NEO-RAIL | LINE-GLASS-FRAME-PUSH |
| 60     |           | P201.060.C | -                      | -    | -   | -                     |
| 70     |           | P201.070.C | -                      | -    | -   | -                     |
| 80     |           | P201.080.C | -                      | -    | -   | -                     |
| 90     |           | P201.090.C | -                      | -    | -   | -                     |
| 100    |           | P201.100.I | -                      | -    | -   | -                     |
| 100    |           | P201.100.C | -                      | -    | -   | -                     |
| 100    |           | P201.100.D | -                      | -    | -   | -                     |
| 120    |           | P201.120.I | -                      | -    | -   | -                     |
| 120    |           | P201.120.C | -                      | -    | -   | -                     |
| 120    |           | P201.120.D | -                      | -    | -   | -                     |
| 120    |           | P201.120.X | -                      | -    | -   | -                     |
| 140    |           | P201.140.I | -                      | -    | -   | -                     |
| 140    |           | P201.140.C | -                      | -    | -   | -                     |
| 140    |           | P201.140.D | -                      | -    | -   | -                     |
| 140    |           | P201.140.X | -                      | -    | -   | -                     |

1 TRONCO

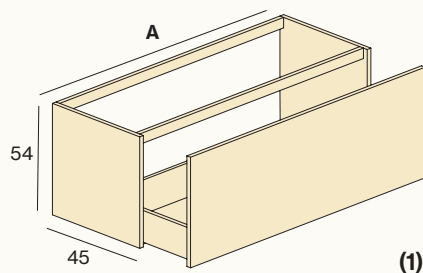

|     |  |            |   |    |   |   |
|-----|--|------------|---|----|---|---|
| 60  |  | P202.060.C | - | -  | - | - |
| 70  |  | P202.070.C | - | -  | - | - |
| 80  |  | P202.080.C | - | -  | - | - |
| 90  |  | P202.090.C | - | -  | - | - |
| 100 |  | P202.100.I | - | -  | - | - |
| 100 |  | P202.100.C | - | -  | - | - |
| 100 |  | P202.100.D | - | -  | - | - |
| 120 |  | P202.120.I | - | -  | - | - |
| 120 |  | P202.120.C | - | -  | - | - |
| 120 |  | P202.120.D | - | -  | - | - |
| 120 |  | P202.120.X | - | -  | - | - |
| 140 |  | P202.140.I | - | ND | - | - |
| 140 |  | P202.140.C | - | ND | - | - |
| 140 |  | P202.140.D | - | ND | - | - |
| 140 |  | P202.140.X | - | ND | - | - |

· Largura 140 cm não acessível para o impulso frente

1 GAVETA + DECORATIVA

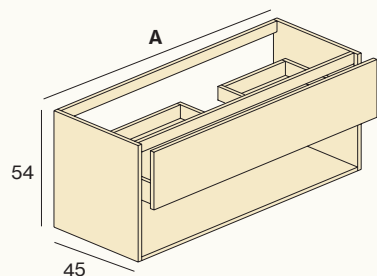

|     |  |            |   |   |   |   |
|-----|--|------------|---|---|---|---|
| 60  |  | P203.060.C | - | - | - | - |
| 70  |  | P203.070.C | - | - | - | - |
| 80  |  | P203.080.C | - | - | - | - |
| 90  |  | P203.090.C | - | - | - | - |
| 100 |  | P203.100.I | - | - | - | - |
| 100 |  | P203.100.C | - | - | - | - |
| 100 |  | P203.100.D | - | - | - | - |
| 120 |  | P203.120.I | - | - | - | - |
| 120 |  | P203.120.C | - | - | - | - |
| 120 |  | P203.120.D | - | - | - | - |
| 120 |  | P203.120.X | - | - | - | - |
| 140 |  | P203.140.I | - | - | - | - |
| 140 |  | P203.140.C | - | - | - | - |
| 140 |  | P203.140.D | - | - | - | - |
| 140 |  | P203.140.X | - | - | - | - |

(1) GAVETA INTERNA

Dentro gaveta interior poderia ser inseriu o composições um com o tronco

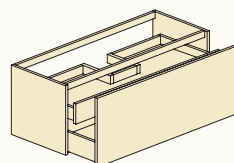

| A (cm) | REF       | PVP |
|--------|-----------|-----|
| 40     | P220.040  | -   |
| 60     | P220.060  | -   |
| 70     | P220.070  | -   |
| 80     | P220.080  | -   |
| 90     | P220.090  | -   |
| 100    | P220.100  | -   |
| 120    | P220.120  | -   |
| 120X   | P220.120X | -   |
| 140    | P220.140  | -   |
| 140X   | P220.140X | -   |

### BASES PARA LAVATÓRIO PENDURADO NA PAREDE

#### 2 GAVETAS + PORTA

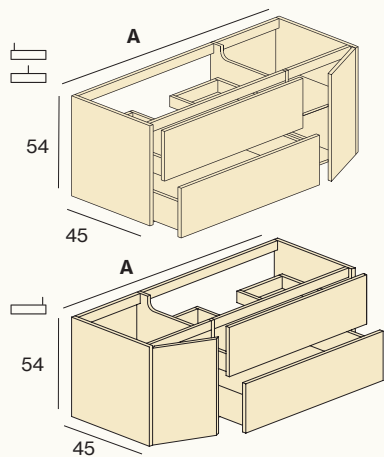

| A (cm) | LAVATÓRIO | REF        | MADEIRA NATURE         |      | LACA  |                       |
|--------|-----------|------------|------------------------|------|---|-----------------------|
|        |           |            | BLACK-INCOLOR-NEO-RAIL | PUSH | BLACK-CURVE-LINEAL-INCOLOR-INGLETE-NEO-RAIL | LINE-GLASS-FRAME-PUSH |
| 120    |           | P204.120.I | -                      | -    | -   | -                     |
| 120    |           | P204.120.C | -                      | -    | -   | -                     |
| 120    |           | P204.120.D | -                      | -    | -   | -                     |
| 140    |           | P204.140.I | -                      | -    | -   | -                     |
| 140    |           | P204.140.C | -                      | -    | -   | -                     |
| 140    |           | P204.140.D | -                      | -    | -   | -                     |
| 160    |           | P204.160.I | -                      | -    | -   | -                     |
| 160    |           | P204.160.C | -                      | -    | -   | -                     |
| 160    |           | P204.160.D | -                      | -    | -   | -                     |
| 180    |           | P204.180.I | -                      | -    | -   | -                     |
| 180    |           | P204.180.C | -                      | -    | -   | -                     |
| 180    |           | P204.180.D | -                      | -    | -   | -                     |

#### TRONCO + 2 GAVETAS ASSIMÉTRICAS

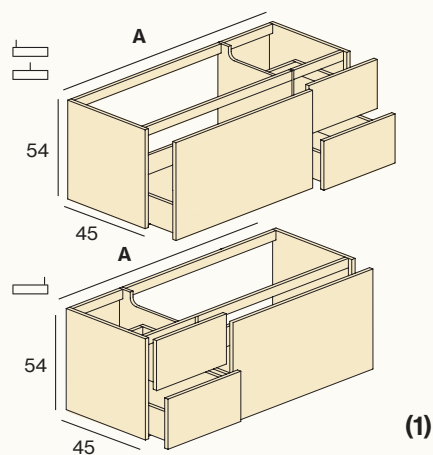

|     |  |            |   |   |   |   |
|-----|--|------------|---|---|---|---|
| 120 |  | P205.120.I | - | - | - | - |
| 120 |  | P205.120.C | - | - | - | - |
| 120 |  | P205.120.D | - | - | - | - |
| 140 |  | P205.140.I | - | - | - | - |
| 140 |  | P205.140.C | - | - | - | - |
| 140 |  | P205.140.D | - | - | - | - |
| 160 |  | P205.160.I | - | - | - | - |
| 160 |  | P205.160.C | - | - | - | - |
| 160 |  | P205.160.D | - | - | - | - |
| 180 |  | P205.180.I | - | - | - | - |
| 180 |  | P205.180.C | - | - | - | - |
| 180 |  | P205.180.D | - | - | - | - |
| 200 |  | P205.200.I | - | - | - | - |
| 200 |  | P205.200.C | - | - | - | - |
| 200 |  | P205.200.D | - | - | - | - |

#### TRONCO + 2 GAVETAS SIMÉTRICAS

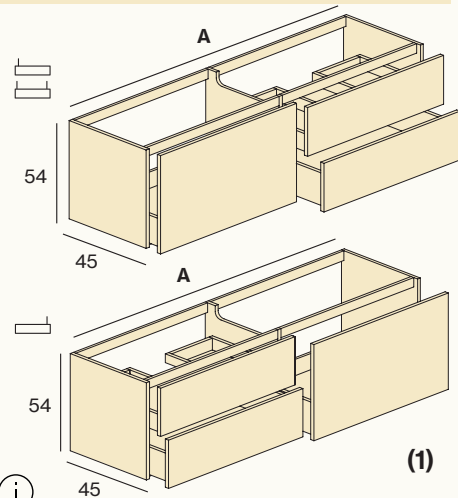

|     |  |            |   |   |   |   |
|-----|--|------------|---|---|---|---|
| 120 |  | P206.120.I | - | - | - | - |
| 120 |  | P206.120.D | - | - | - | - |
| 120 |  | P206.120.X | - | - | - | - |
| 140 |  | P206.140.I | - | - | - | - |
| 140 |  | P206.140.D | - | - | - | - |
| 140 |  | P206.140.X | - | - | - | - |
| 160 |  | P206.160.I | - | - | - | - |
| 160 |  | P206.160.D | - | - | - | - |
| 160 |  | P206.160.X | - | - | - | - |
| 180 |  | P206.180.I | - | - | - | - |
| 180 |  | P206.180.D | - | - | - | - |
| 180 |  | P206.180.X | - | - | - | - |
| 200 |  | P206.200.I | - | - | - | - |
| 200 |  | P206.200.D | - | - | - | - |
| 200 |  | P206.200.X | - | - | - | - |

- As composições assimétricas têm a seguinte modulação: 120 (80 + 40), 140 (80 + 60), 160 (100 + 60), 180 (120 + 60), 200 (120 + 80). Outras configurações disponíveis
- Móveis especiais: para medidas intermediárias de largura e / ou altura, tome o preço da medida imediatamente superior.

#### & complementa

Organizadores, pés, toalheiros, retroiluminação página....248

- C Lavatório centrado
- D Lavatório direita
- I Lavatório esquerda
- X Lavatório duplo



BASES PARA LAVATÓRIO PENDURADO NA PAREDE

4 GAVETAS ASSIMÉTRICAS

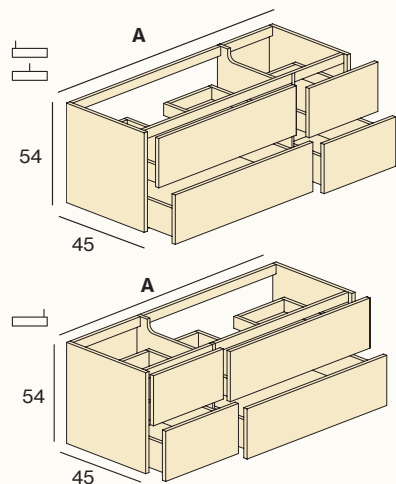

| A (cm) | LAVATÓRIO | REF        | MADEIRA NATURE         |      | LACA  |                       |
|--------|-----------|------------|------------------------|------|---|-----------------------|
|        |           |            | BLACK-INCOLOR-NEO-RAIL | PUSH | BLACK-CURVE-LINEAL-INCOLOR-INGLETE-NEO-RAIL | LINE-GLASS-FRAME-PUSH |
| 120    |           | P208.120.I | -                      | -    | -   | -                     |
| 120    |           | P208.120.C | -                      | -    | -   | -                     |
| 120    |           | P208.120.D | -                      | -    | -   | -                     |
| 140    |           | P208.140.I | -                      | -    | -   | -                     |
| 140    |           | P208.140.C | -                      | -    | -   | -                     |
| 140    |           | P208.140.D | -                      | -    | -   | -                     |
| 160    |           | P208.160.I | -                      | -    | -   | -                     |
| 160    |           | P208.160.C | -                      | -    | -   | -                     |
| 160    |           | P208.160.D | -                      | -    | -   | -                     |
| 180    |           | P208.180.I | -                      | -    | -   | -                     |
| 180    |           | P208.180.C | -                      | -    | -   | -                     |
| 180    |           | P208.180.D | -                      | -    | -   | -                     |
| 200    |           | P208.200.I | -                      | -    | -   | -                     |
| 200    |           | P208.200.C | -                      | -    | -   | -                     |
| 200    |           | P208.200.D | -                      | -    | -   | -                     |

4 GAVETAS SIMÉTRICAS

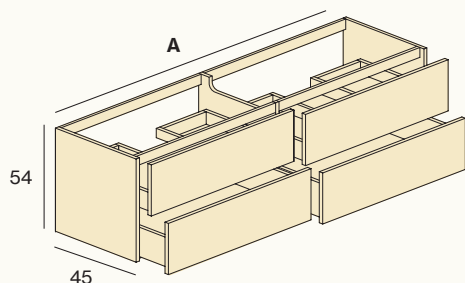

|     |  |            |   |   |   |   |
|-----|--|------------|---|---|---|---|
| 120 |  | P209.120.I | - | - | - | - |
| 120 |  | P209.120.D | - | - | - | - |
| 120 |  | P209.120.X | - | - | - | - |
| 140 |  | P209.140.I | - | - | - | - |
| 140 |  | P209.140.D | - | - | - | - |
| 140 |  | P209.140.X | - | - | - | - |
| 160 |  | P209.160.I | - | - | - | - |
| 160 |  | P209.160.D | - | - | - | - |
| 160 |  | P209.160.X | - | - | - | - |
| 180 |  | P209.180.I | - | - | - | - |
| 180 |  | P209.180.D | - | - | - | - |
| 180 |  | P209.180.X | - | - | - | - |
| 200 |  | P209.200.I | - | - | - | - |
| 200 |  | P209.200.D | - | - | - | - |
| 200 |  | P209.200.X | - | - | - | - |

2 GAVETAS + DECORATIVAS

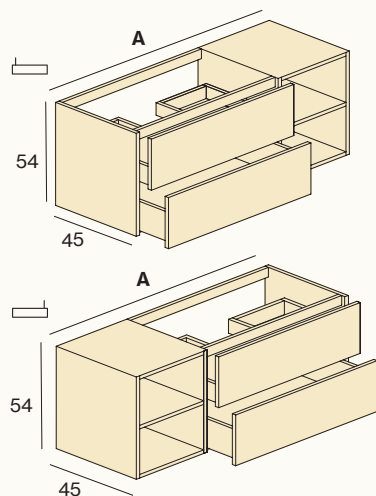

|     |  |            |   |   |   |   |
|-----|--|------------|---|---|---|---|
| 120 |  | P207.120.I | - | - | - | - |
| 120 |  | P207.120.D | - | - | - | - |
| 140 |  | P207.140.I | - | - | - | - |
| 140 |  | P207.140.D | - | - | - | - |
| 160 |  | P207.160.I | - | - | - | - |
| 160 |  | P207.160.D | - | - | - | - |
| 180 |  | P207.180.I | - | - | - | - |
| 180 |  | P207.180.D | - | - | - | - |

(1) GAVETA INTERNA

Dentro gaveta interior poderia ser inseriu o composições um com o tronco

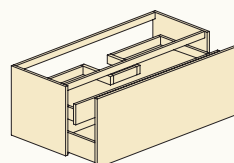

| A (cm) | REF       | PVP |
|--------|-----------|-----|
| 40     | P220.040  | -   |
| 60     | P220.060  | -   |
| 70     | P220.070  | -   |
| 80     | P220.080  | -   |
| 90     | P220.090  | -   |
| 100    | P220.100  | -   |
| 120    | P220.120  | -   |
| 120X   | P220.120X | -   |
| 140    | P220.140  | -   |
| 140X   | P220.140X | -   |

BASES PARA LAVATÓRIO PENDURADO NA PAREDE

2 TRONCOS ASIMÉTRICOS

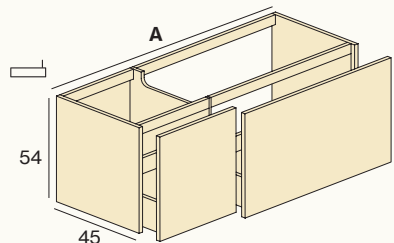
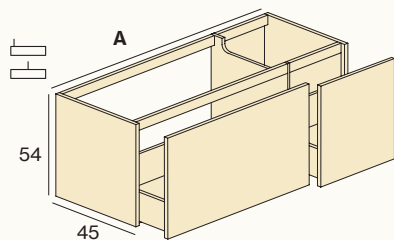

(1)

2 TRONCOS SIMÉTRICOS

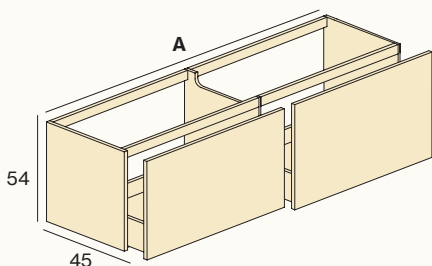

(1)

1 GAVETA + TRONCO

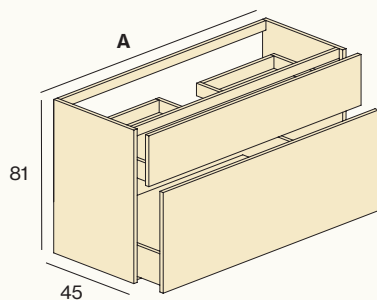

(1)

| A (cm) | LAVATÓRIO | REF        | MADEIRA NATURE         |      | LACA  |                       |
|--------|-----------|------------|------------------------|------|---|-----------------------|
|        |           |            | BLACK-INCOLOR-NEO-RAIL | PUSH | BLACK-CURVE-LINEAL-INCOLOR-INGLETE-NEO-RAIL | LINE-GLASS-FRAME-PUSH |
| 120    |           | P210.120.I | -                      | -    | -   | -                     |
| 120    |           | P210.120.C | -                      | -    | -   | -                     |
| 120    |           | P210.120.D | -                      | -    | -   | -                     |
| 140    |           | P210.140.I | -                      | -    | -   | -                     |
| 140    |           | P210.140.C | -                      | -    | -   | -                     |
| 140    |           | P210.140.D | -                      | -    | -   | -                     |
| 160    |           | P210.160.I | -                      | -    | -   | -                     |
| 160    |           | P210.160.C | -                      | -    | -   | -                     |
| 160    |           | P210.160.D | -                      | -    | -   | -                     |
| 180    |           | P210.180.I | -                      | -    | -   | -                     |
| 180    |           | P210.180.C | -                      | -    | -   | -                     |
| 180    |           | P210.180.D | -                      | -    | -   | -                     |
| 200    |           | P210.200.I | -                      | -    | -   | -                     |
| 200    |           | P210.200.C | -                      | -    | -   | -                     |
| 200    |           | P210.200.D | -                      | -    | -   | -                     |

|     |  |            |   |   |   |   |
|-----|--|------------|---|---|---|---|
| 120 |  | P211.120.I | - | - | - | - |
| 120 |  | P211.120.D | - | - | - | - |
| 120 |  | P211.120.X | - | - | - | - |
| 140 |  | P211.140.I | - | - | - | - |
| 140 |  | P211.140.D | - | - | - | - |
| 140 |  | P211.140.X | - | - | - | - |
| 160 |  | P211.160.I | - | - | - | - |
| 160 |  | P211.160.D | - | - | - | - |
| 160 |  | P211.160.X | - | - | - | - |
| 180 |  | P211.180.I | - | - | - | - |
| 180 |  | P211.180.D | - | - | - | - |
| 180 |  | P211.180.X | - | - | - | - |
| 200 |  | P211.200.I | - | - | - | - |
| 200 |  | P211.200.D | - | - | - | - |
| 200 |  | P211.200.X | - | - | - | - |

|     |  |            |   |   |   |   |
|-----|--|------------|---|---|---|---|
| 60  |  | P312.060.C | - | - | - | - |
| 70  |  | P312.070.C | - | - | - | - |
| 80  |  | P312.080.C | - | - | - | - |
| 90  |  | P312.090.C | - | - | - | - |
| 100 |  | P312.100.I | - | - | - | - |
| 100 |  | P312.100.C | - | - | - | - |
| 100 |  | P312.100.D | - | - | - | - |
| 120 |  | P312.120.I | - | - | - | - |
| 120 |  | P312.120.C | - | - | - | - |
| 120 |  | P312.120.D | - | - | - | - |



· As composições assimétricas têm a seguinte modulação: 120 (80 + 40), 140 (80 + 60), 160 (100 + 60), 180 (120 + 60), 200 (120 + 80). Outras configurações disponíveis  
 · Móveis especiais: para medidas intermediárias de largura e / ou altura, tome o preço da medida imediatamente superior.

**& complementa**

Organizadores, pés, toalheiros, retroiluminação página....248

- C Lavatório centrado
- D Lavatório direita
- I Lavatório esquerda
- X Lavatório duplo

BASES PARA LAVATÓRIO PENDURADO NA PAREDE

3 GAVETAS

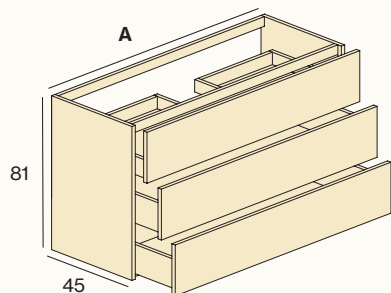

| A (cm) | LAVATÓRIO | REF        | MADEIRA NATURE         |      | LACA  |                       |
|--------|-----------|------------|------------------------|------|---|-----------------------|
|        |           |            | BLACK-INCOLOR-NEO-RAIL | PUSH | BLACK-CURVE-LINEAL-INCOLOR-INGLETE-NEO-RAIL | LINE-GLASS-FRAME-PUSH |
| 60     |           | P313.060.C | -                      | -    | -   | -                     |
| 70     |           | P313.070.C | -                      | -    | -   | -                     |
| 80     |           | P313.080.C | -                      | -    | -   | -                     |
| 90     |           | P313.090.C | -                      | -    | -   | -                     |
| 100    |           | P313.100.I | -                      | -    | -   | -                     |
| 100    |           | P313.100.C | -                      | -    | -   | -                     |
| 100    |           | P313.100.D | -                      | -    | -   | -                     |
| 120    |           | P313.120.I | -                      | -    | -   | -                     |
| 120    |           | P313.120.C | -                      | -    | -   | -                     |
| 120    |           | P313.120.D | -                      | -    | -   | -                     |

BASES DE LAVATÓRIO EM METAL SUSPENSO

ESTRUTURA METÁLICA SUSPENSA

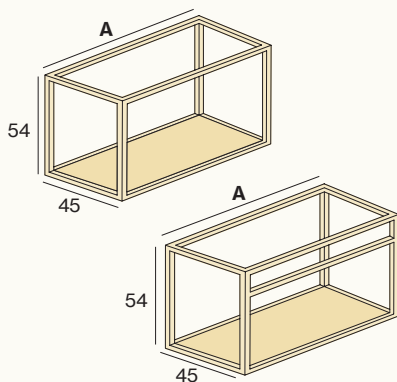

| A (cm) | REF        | NEGRO          |      |                | COR            |      |                |
|--------|------------|----------------|------|----------------|----------------|------|----------------|
|        |            | MADEIRA NATURE | LACA | CRISTAL FUMAÇA | MADEIRA NATURE | LACA | CRISTAL FUMAÇA |
| 60     | P214.060.C | -              | -    | -              | -              | -    | -              |
| 70     | P214.070.C | -              | -    | -              | -              | -    | -              |
| 80     | P214.080.C | -              | -    | -              | -              | -    | -              |
| 90     | P214.090.C | -              | -    | -              | -              | -    | -              |
| 100    | P214.100.C | -              | -    | -              | -              | -    | -              |
| 120    | P214.120.C | -              | -    | -              | -              | -    | -              |
| 140    | P214.140.C | -              | -    | -              | -              | -    | -              |
| 60     | P216.060.C | -              | -    | -              | -              | -    | -              |
| 70     | P216.070.C | -              | -    | -              | -              | -    | -              |
| 80     | P216.080.C | -              | -    | -              | -              | -    | -              |
| 90     | P216.090.C | -              | -    | -              | -              | -    | -              |
| 100    | P216.100.C | -              | -    | -              | -              | -    | -              |
| 120    | P216.120.C | -              | -    | -              | -              | -    | -              |
| 140    | P216.140.C | -              | -    | -              | -              | -    | -              |

ESTRUTURA PISO METÁLICO

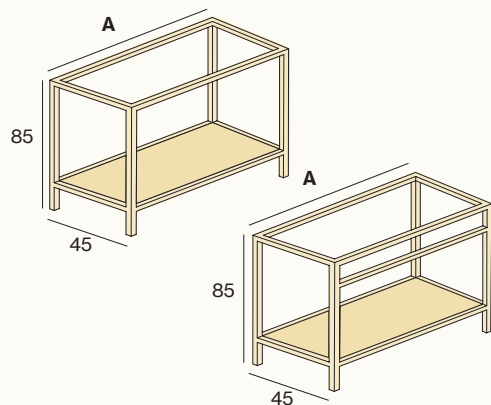

|     |            |   |   |   |   |   |   |
|-----|------------|---|---|---|---|---|---|
| 60  | P215.060.C | - | - | - | - | - | - |
| 70  | P215.070.C | - | - | - | - | - | - |
| 80  | P215.080.C | - | - | - | - | - | - |
| 90  | P215.090.C | - | - | - | - | - | - |
| 100 | P215.100.C | - | - | - | - | - | - |
| 120 | P215.120.C | - | - | - | - | - | - |
| 140 | P215.140.C | - | - | - | - | - | - |
| 60  | P217.060.C | - | - | - | - | - | - |
| 70  | P217.070.C | - | - | - | - | - | - |
| 80  | P217.080.C | - | - | - | - | - | - |
| 90  | P217.090.C | - | - | - | - | - | - |
| 100 | P217.100.C | - | - | - | - | - | - |
| 120 | P217.120.C | - | - | - | - | - | - |
| 140 | P217.140.C | - | - | - | - | - | - |

(1) GAVETA INTERNA

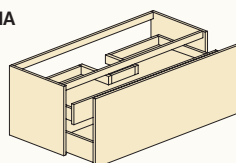

Dentro gaveta interior poderia ser inseriu o composições um com o tronco

| A (cm) | REF       | PVP |
|--------|-----------|-----|
| 40     | P220.040  | -   |
| 60     | P220.060  | -   |
| 70     | P220.070  | -   |
| 80     | P220.080  | -   |
| 90     | P220.090  | -   |
| 100    | P220.100  | -   |
| 120    | P220.120  | -   |
| 120X   | P220.120X | -   |
| 140    | P220.140  | -   |
| 140X   | P220.140X | -   |

### MÓDULOS SUSPENDIDOS

#### 1 GAVETA / BANCO

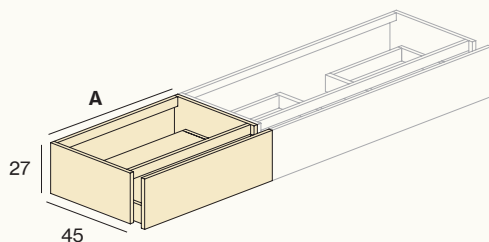

| A (cm) | REF        | MADEIRA NATURE         |      | LACA  |                       |
|--------|------------|------------------------|------|---|-----------------------|
|        |            | BLACK-INCOLOR-NEO-RAIL | PUSH | BLACK-CURVE-LINEAL-INCOLOR-INGLETE-NEO-RAIL | LINE-GLASS-FRAME-PUSH |
| 30     | P101.030.M | -                      | -    | -   | -                     |
| 40     | P101.040.M | -                      | -    | -   | -                     |
| 60     | P101.060.M | -                      | -    | -   | -                     |
| 70     | P101.070.M | -                      | -    | -   | -                     |
| 80     | P101.080.M | -                      | -    | -   | -                     |
| 90     | P101.090.M | -                      | -    | -   | -                     |
| 100    | P101.100.M | -                      | -    | -   | -                     |
| 120    | P101.120.M | -                      | -    | -   | -                     |
| 140    | P101.140.M | -                      | -    | -   | -                     |

#### 2 GAVETAS / BANCO

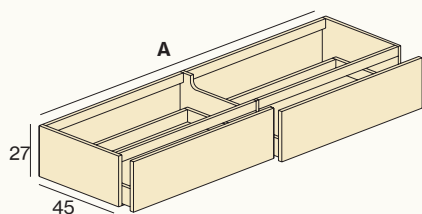

|     |            |   |   |   |   |
|-----|------------|---|---|---|---|
| 120 | P103.120.M | - | - | - | - |
| 140 | P103.140.M | - | - | - | - |
| 160 | P103.160.M | - | - | - | - |
| 180 | P103.180.M | - | - | - | - |
| 200 | P103.200.M | - | - | - | - |

#### DECORATIVO

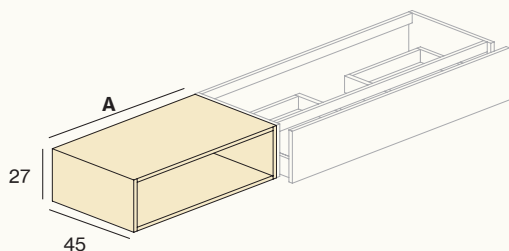

|    |            |   |   |   |   |
|----|------------|---|---|---|---|
| 30 | P104.030.M | - | - | - | - |
| 40 | P104.040.M | - | - | - | - |
| 60 | P104.060.M | - | - | - | - |
| 70 | P104.070.M | - | - | - | - |
| 80 | P104.080.M | - | - | - | - |



· Você pode criar seus próprios móveis personalizados adicionando os módulos à direita e / ou à esquerda da base do lavatório selecionada. Especifique a localização deles

MÓDULOS SUSPENDIDOS

1 PORTA

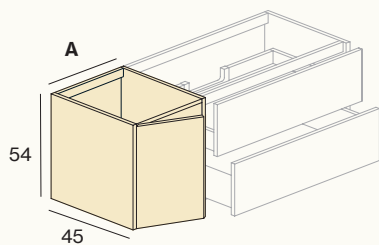

| A (cm) | PORTA | REF         | MADEIRA NATURE         |      | LACA  |                       |
|--------|-------|-------------|------------------------|------|---|-----------------------|
|        |       |             | BLACK-INCOLOR-NEO-RAIL | PUSH | BLACK-CURVE-LINEAL-INCOLOR-INGLETE-NEO-RAIL | LINE-GLASS-FRAME-PUSH |
| 30     |       | P204.030.MI | -                      | -    | -   | -                     |
| 30     |       | P204.030.MD | -                      | -    | -   | -                     |
| 40     |       | P204.040.MI | -                      | -    | -   | -                     |
| 40     |       | P204.040.MD | -                      | -    | -   | -                     |

2 GAVETAS

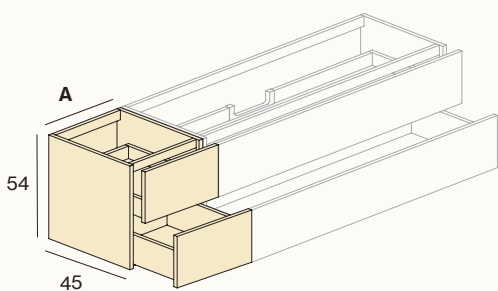

| A (cm) | REF        | MADEIRA NATURE         |      | LACA  |                       |
|--------|------------|------------------------|------|---|-----------------------|
|        |            | BLACK-INCOLOR-NEO-RAIL | PUSH | BLACK-CURVE-LINEAL-INCOLOR-INGLETE-NEO-RAIL | LINE-GLASS-FRAME-PUSH |
| 30     | P201.030.M | -                      | -    | -   | -                     |
| 40     | P201.040.M | -                      | -    | -   | -                     |
| 60     | P201.060.M | -                      | -    | -   | -                     |
| 70     | P201.070.M | -                      | -    | -   | -                     |
| 80     | P201.080.M | -                      | -    | -   | -                     |
| 90     | P201.090.M | -                      | -    | -   | -                     |
| 100    | P201.100.M | -                      | -    | -   | -                     |
| 120    | P201.120.M | -                      | -    | -   | -                     |
| 140    | P201.140.M | -                      | -    | -   | -                     |

1 TRONCO

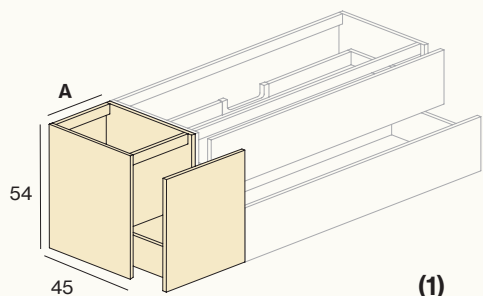

|     |            |   |    |   |   |
|-----|------------|---|----|---|---|
| 30  | P202.030.M | - | -  | - | - |
| 40  | P202.040.M | - | -  | - | - |
| 60  | P202.060.M | - | -  | - | - |
| 70  | P202.070.M | - | -  | - | - |
| 80  | P202.080.M | - | -  | - | - |
| 90  | P202.090.M | - | -  | - | - |
| 100 | P202.100.M | - | -  | - | - |
| 120 | P202.120.M | - | -  | - | - |
| 140 | P202.140.M | - | ND | - | - |

· Para largura de 140 cm não disponível com push frontal.

**(1)** GAVETA INTERNA  
Dentro gaveta interior poderia ser inseriu o composições um com o tronco

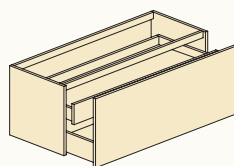

| A (cm) | REF      | PVP |
|--------|----------|-----|
| 40     | A221.040 | -   |
| 60     | A221.060 | -   |
| 70     | A221.070 | -   |
| 80     | A221.080 | -   |
| 90     | A221.090 | -   |
| 100    | A221.100 | -   |
| 120    | A221.120 | -   |
| 140    | A221.140 | -   |

MÓDULOS SUSPENDIDOS

1 GAVETA + DECORATIVA

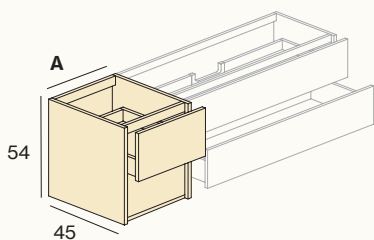

| A (cm) | REF        | MADEIRA NATURE         |      | LACA  |                       |
|--------|------------|------------------------|------|---|-----------------------|
|        |            | BLACK-INCOLOR-NEO-RAIL | PUSH | BLACK-CURVE-LINEAL-INCOLOR-INGLETE-NEO-RAIL | LINE-GLASS-FRAME-PUSH |
| 30     | P203.030.M | -                      | -    | -   | -                     |
| 40     | P203.040.M | -                      | -    | -   | -                     |
| 60     | P203.060.M | -                      | -    | -   | -                     |
| 70     | P203.070.M | -                      | -    | -   | -                     |
| 80     | P203.080.M | -                      | -    | -   | -                     |
| 90     | P203.090.M | -                      | -    | -   | -                     |
| 100    | P203.100.M | -                      | -    | -   | -                     |
| 120    | P203.120.M | -                      | -    | -   | -                     |
| 140    | P203.140.M | -                      | -    | -   | -                     |

PRATELEIRAS DECORATIVAS

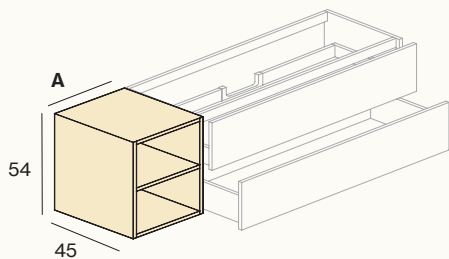

|    |            |   |   |   |   |
|----|------------|---|---|---|---|
| 30 | P207.030.M | - | - | - | - |
| 40 | P207.040.M | - | - | - | - |
| 60 | P207.060.M | - | - | - | - |
| 70 | P207.070.M | - | - | - | - |
| 80 | P207.080.M | - | - | - | - |

1 GAVETA + PORTA

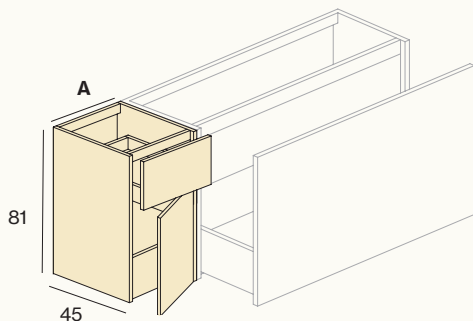

| A (cm) | PORTA | REF         | MADEIRA NATURE         |      | LACA  |                       |
|--------|-------|-------------|------------------------|------|---|-----------------------|
|        |       |             | BLACK-INCOLOR-NEO-RAIL | PUSH | BLACK-CURVE-LINEAL-INCOLOR-INGLETE-NEO-RAIL | LINE-GLASS-FRAME-PUSH |
| 30     |       | P314.030.MI | -                      | -    | -   | -                     |
| 30     |       | P314.030.MD | -                      | -    | -   | -                     |
| 40     |       | P314.040.MI | -                      | -    | -   | -                     |
| 40     |       | P314.040.MD | -                      | -    | -   | -                     |



· Você pode criar seus próprios móveis personalizados adicionando os módulos à direita e / ou à esquerda da base do lavatório selecionada. Especifique sua localização.

MÓDULOS SUSPENDIDOS

3 GAVETAS

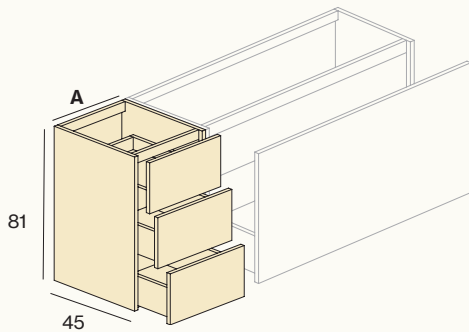

| A (cm) | REF        | MADEIRA NATURE         |      | LACA  |                       |
|--------|------------|------------------------|------|---|-----------------------|
|        |            | BLACK-INCOLOR-NEO-RAIL | PUSH | BLACK-CURVE-LINEAL-INCOLOR-INGLETE-NEO-RAIL | LINE-GLASS-FRAME-PUSH |
| 30     | P313.030.M | -                      | -    | -   | -                     |
| 40     | P313.040.M | -                      | -    | -   | -                     |
| 60     | P313.060.M | -                      | -    | -   | -                     |
| 70     | P313.070.M | -                      | -    | -   | -                     |
| 80     | P313.080.M | -                      | -    | -   | -                     |
| 90     | P313.090.M | -                      | -    | -   | -                     |
| 100    | P313.100.M | -                      | -    | -   | -                     |
| 120    | P313.120.M | -                      | -    | -   | -                     |

MÓDULOS DE ESTRUTURA METÁLICA SUSPENSOS

DECORATIVO METÁLICO

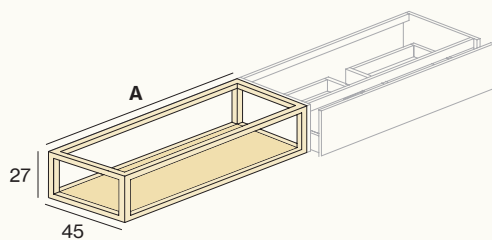

| A (cm) | REF        | NEGRO          |      |                | COLOR          |      |                |
|--------|------------|----------------|------|----------------|----------------|------|----------------|
|        |            | MADEIRA NATURE | LACA | CRISTAL FUMAÇA | MADEIRA NATURE | LACA | CRISTAL FUMAÇA |
| 30     | P105.030.M | -              | -    | -              | -              | -    | -              |
| 40     | P105.040.M | -              | -    | -              | -              | -    | -              |
| 60     | P105.060.M | -              | -    | -              | -              | -    | -              |
| 70     | P105.070.M | -              | -    | -              | -              | -    | -              |
| 80     | P105.080.M | -              | -    | -              | -              | -    | -              |
| 90     | P105.090.M | -              | -    | -              | -              | -    | -              |
| 100    | P105.100.M | -              | -    | -              | -              | -    | -              |
| 120    | P105.120.M | -              | -    | -              | -              | -    | -              |
| 140    | P105.140.M | -              | -    | -              | -              | -    | -              |

DECORATIVO H54

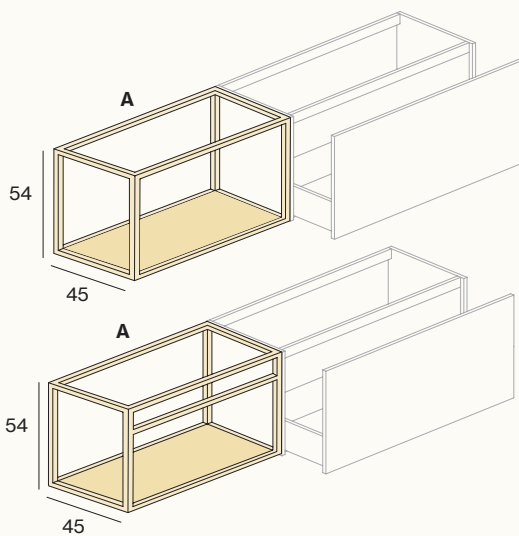

|     |            |   |   |   |   |   |   |
|-----|------------|---|---|---|---|---|---|
| 30  | P214.030.M | - | - | - | - | - | - |
| 40  | P214.040.M | - | - | - | - | - | - |
| 60  | P214.060.M | - | - | - | - | - | - |
| 70  | P214.070.M | - | - | - | - | - | - |
| 80  | P214.080.M | - | - | - | - | - | - |
| 90  | P214.090.M | - | - | - | - | - | - |
| 100 | P214.100.M | - | - | - | - | - | - |
| 120 | P214.120.M | - | - | - | - | - | - |
| 140 | P214.140.M | - | - | - | - | - | - |

  

|     |            |   |   |   |   |   |   |
|-----|------------|---|---|---|---|---|---|
| 30  | P216.030.M | - | - | - | - | - | - |
| 40  | P216.040.M | - | - | - | - | - | - |
| 60  | P216.060.M | - | - | - | - | - | - |
| 70  | P216.070.M | - | - | - | - | - | - |
| 80  | P216.080.M | - | - | - | - | - | - |
| 90  | P216.090.M | - | - | - | - | - | - |
| 100 | P216.100.M | - | - | - | - | - | - |
| 120 | P216.120.M | - | - | - | - | - | - |
| 140 | P216.140.M | - | - | - | - | - | - |

### MÓVEIS INTERIORES

#### DECOSPACE

Sistema que inclui um sifão que economiza espaço e uma válvula click-clack de cromo polido. Esta solução permite que a gaveta superior fique sem registro de sifão.

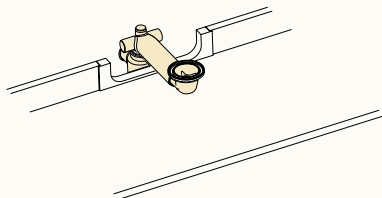

| REF    | PVP |
|--------|-----|
| CM13   | -   |
| CM13X2 | -   |

#### ORGADRAW

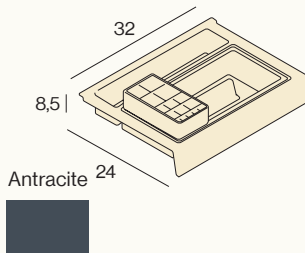

| REF | PVP |
|-----|-----|
| CM1 | -   |

#### ORGASTRIP

Sistema de separação guiada por trilhos.

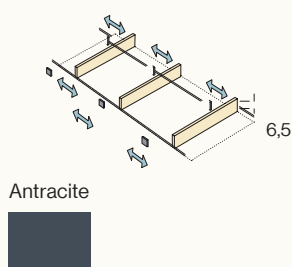

| A   | REF     | SEPARATORÉ | PVP |
|-----|---------|------------|-----|
| 30  | CM2.030 | 1          | -   |
| 40  | CM2.040 | 1          | -   |
| 60  | CM2.060 | 2          | -   |
| 70  | CM2.070 | 2          | -   |
| 80  | CM2.080 | 3          | -   |
| 90  | CM2.090 | 3          | -   |
| 100 | CM2.100 | 4          | -   |
| 120 | CM2.120 | 4          | -   |
| 140 | CM2.140 | 4          | -   |

#### Separador adicional

|         |   |   |
|---------|---|---|
| CM2.010 | 1 | - |
|---------|---|---|

#### PROTEÇÃO DE GAVETA

Folha de proteção antiderrapante para gaveta.



| A   | PÉROLA  |     | TELHA   |     |
|-----|---------|-----|---------|-----|
|     | REF     | PVP | REF     | PVP |
| 30  | CM3.030 | -   | CM4.030 | -   |
| 40  | CM3.040 | -   | CM4.040 | -   |
| 60  | CM3.060 | -   | CM4.060 | -   |
| 70  | CM3.070 | -   | CM4.070 | -   |
| 80  | CM3.080 | -   | CM4.080 | -   |
| 90  | CM3.090 | -   | CM4.090 | -   |
| 100 | CM3.100 | -   | CM4.100 | -   |
| 120 | CM3.120 | -   | CM4.120 | -   |
| 140 | CM3.140 | -   | CM4.140 | -   |



PATAS DE PEÇA DE MOBILIÁRIO

ESTRUTURA METÁLICA COM PRATELEIRA PARA MÓVEIS H27

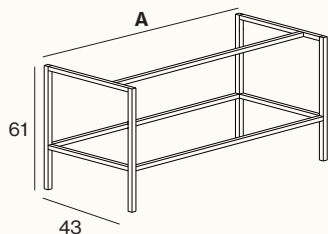

| A (cm) | REF      | NEGRO          |      |                | COR            |      |                |
|--------|----------|----------------|------|----------------|----------------|------|----------------|
|        |          | MADEIRA NATURE | LACA | CRISTAL FUMAÇA | MADEIRA NATURE | LACA | CRISTAL FUMAÇA |
| 60     | CM14.060 | -              | -    | -              | -              | -    | -              |
| 70     | CM14.070 | -              | -    | -              | -              | -    | -              |
| 80     | CM14.080 | -              | -    | -              | -              | -    | -              |
| 90     | CM14.090 | -              | -    | -              | -              | -    | -              |
| 100    | CM14.100 | -              | -    | -              | -              | -    | -              |
| 120    | CM14.120 | -              | -    | -              | -              | -    | -              |
| 140    | CM14.140 | -              | -    | -              | -              | -    | -              |

Cores



ESTRUTURA METÁLICA PARA MÓVEIS H54

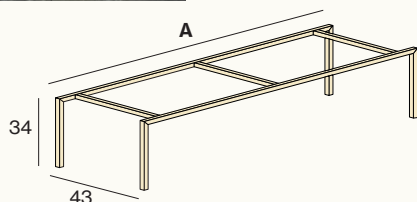

| A   | REF     | NEGRO | COR |
|-----|---------|-------|-----|
| 60  | CM5.060 | -     | -   |
| 70  | CM5.070 | -     | -   |
| 80  | CM5.080 | -     | -   |
| 90  | CM5.090 | -     | -   |
| 100 | CM5.100 | -     | -   |
| 120 | CM5.120 | -     | -   |
| 140 | CM5.140 | -     | -   |
| 160 | CM5.160 | -     | -   |
| 180 | CM5.180 | -     | -   |
| 200 | CM5.200 | -     | -   |

A medida da parte inferior da estrutura é aproximadamente 2 centímetros inferior à da parte inferior do gabinete para não interferir nas frentes.

Cores



PÉS H3

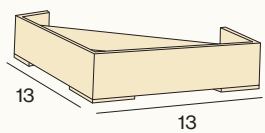

Cromada brilho



REF

PVP

CM6

-

3,6 Conjunto de 4 unidades

PÉS H7

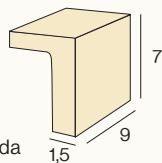

Cromada brilho



REF

PVP

CM7

-

7 Conjunto de 4 unidades

MÓVEIS EXTERIORES

PORTA TOALHA LATERAL

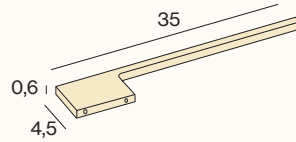

| COR              | REF    | PVP |
|------------------|--------|-----|
| Cromada brilho   | CM8.CB | -   |
| Preto mate       | CM8.BK | -   |
| Cor (carta laca) | CM8.CO | -   |

Cores



PORTA TOALHA COM PÉS

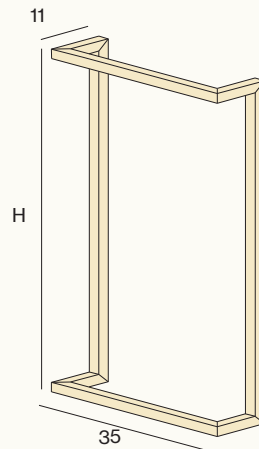

| H  | COR              | REF       | PVP |
|----|------------------|-----------|-----|
| 75 | Preto mate       | CM9.75.BK | -   |
| 75 | Cor (carta laca) | CM9.75.CO | -   |
| 85 | Preto mate       | CM9.85.BK | -   |
| 85 | Cor (carta laca) | CM9.85.CO | -   |

Gabinete H = 85 cm com pia integrada.

Gabinete H = 75 cm com pia do fogão.

Cores



LUZ DE FUNDO INFERIOR

Iluminação sob a mobília, sob o teto falso, móvel de parede ou coluna.

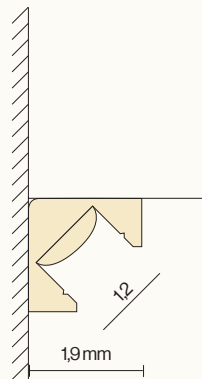

| A   | REF      | PVP |
|-----|----------|-----|
| 60  | CM10.060 | -   |
| 70  | CM10.070 | -   |
| 80  | CM10.080 | -   |
| 90  | CM10.090 | -   |
| 100 | CM10.100 | -   |
| 120 | CM10.120 | -   |
| 140 | CM10.140 | -   |
| 160 | CM10.160 | -   |
| 180 | CM10.180 | -   |
| 200 | CM10.200 | -   |

La medida real de la iluminación LED es 4 centímetros inferior respecto el ancho del mueble para que no se vea desde el lateral.

| LUZ | COR °K           | CONSUMO | POTÊNCIA                   | ESTADO | DRIVER   | MATERIAL |
|-----|------------------|---------|----------------------------|--------|----------|----------|
| LED | 4000°K<br>Neutro | 4,8W    | 400 LUMENS<br>metro linear | IP67   | INCLUÍDO | ALUMÍNIO |

Personaliza teu LED em 3000°K e 4200°K sem cargo. Standard de 4000°K.

MÓVEIS EXTERIORES

TIRA DE AJUSTE DA PAREDE



| H  | REF     | MADEIRA NATURE | LACA |
|----|---------|----------------|------|
| 27 | CM11.27 | -              | -    |
| 54 | CM11.54 | -              | -    |
| 81 | CM11.81 | -              | -    |

X a ser definido conforme necessário.

LATERAIS DECORATIVOS

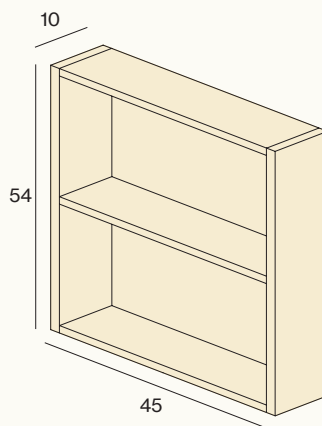

| REF  | MADEIRA NATURE | LACA |
|------|----------------|------|
| CM12 | -              | -    |



# Step

|                              |     |
|------------------------------|-----|
| Recursos e equipamentos      | 254 |
| Personalize seus móveis Step | 255 |
| Bases de lavatório suspensas | 256 |
| Bases suspensas + bancadas   | 257 |



### 3D GAVETAS

Gavetas Hettich em metal antracite com 3 regulagens. Os guias possuem extensão total e sistema de frenagem progressiva.

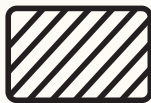

### ANTRACITE FULLCOLOR

Conceito de design de interiores onde todos os materiais do interior do móvel são desenhados em antracite. O gabinete com acabamento lacado é lacado internamente em antracite.



### DECOBUILD SYSTEM

Móveis feitos com placas de 19 mm colados com cutelos obtendo uma estética limpa sem encaixes visíveis e oferecendo maior resistência e durabilidade.



### SISTEMA DE PAREDE DIVULGAÇÃO AUTOMÁTICA

Este sistema de fixação de parede tem segurança anti-gotejamento com capacidade de carga de 150 Kg.

## Escolha o seu pacote Step e personalize-o

Nossa seleção está sempre disponível

- ✔ Um acabamento
- ✔ Duas cores
- ✔ Três bancadas

### A Escolha a cor

Lacado

Blanco Mate

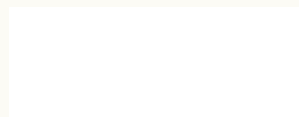

Madeira Nature

Sand



### B Escolha a bancada

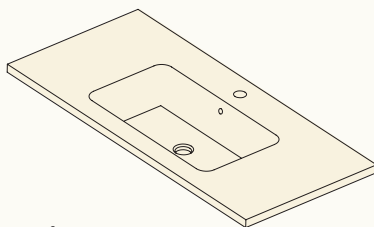

CERÂMICA

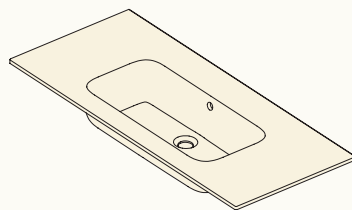

SOLID MINERAL - BRILHO

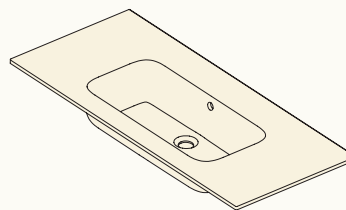

SOLID MINERAL - MATE

## BASES PARA LAVATÓRIO PENDURADO NA PAREDE

## 2 GAVETAS

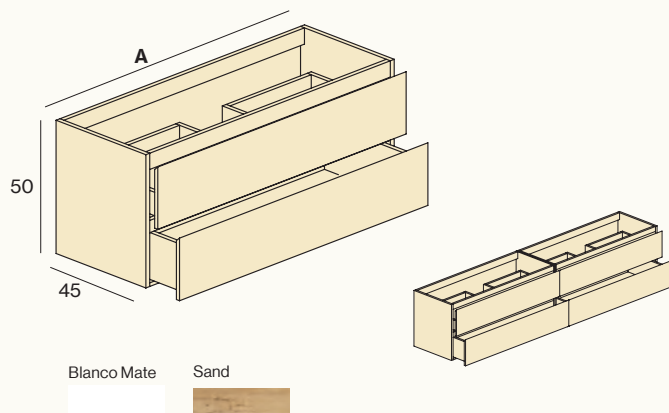

| A (cm) | LAVATÓRIO | BLANCO      | SAND        | PVP |
|--------|-----------|-------------|-------------|-----|
|        |           | REF         | REF         |     |
| 60     |           | S201.060.CB | S201.060.CS | -   |
| 80     |           | S201.080.CB | S201.080.CS | -   |
| 100    |           | S201.100.CB | S201.100.CS | -   |
| 120    |           | S201.120.CB | S201.120.CS | -   |
| 120X   |           | S201.120.XB | S201.120.XS | -   |



· Produto em estoque.



## PACOTE DE MÓVEIS + TAMPA DE TRABALHO

## 2 GAVETAS + TAMPO DE CERÂMICA

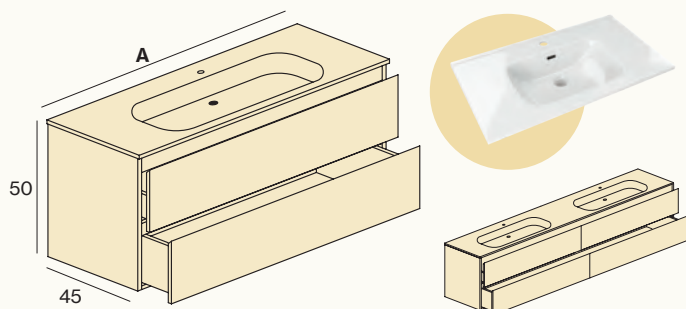

Blanco Mate

Sand

| A (cm) | LAVATÓRIO | BLANCO      | SAND        | PVP |
|--------|-----------|-------------|-------------|-----|
|        |           | REF         | REF         |     |
| 60     |           | S901.060.CB | S901.060.CS | -   |
| 80     |           | S901.080.CB | S901.080.CS | -   |
| 100    |           | S901.100.CB | S901.100.CS | -   |
| 120    |           | S901.120.CB | S901.120.CS | -   |
| 120X   |           | S901.120.XB | S901.120.XS | -   |

## 2 GAVETAS + WORKTOP - HARD (Brilho)

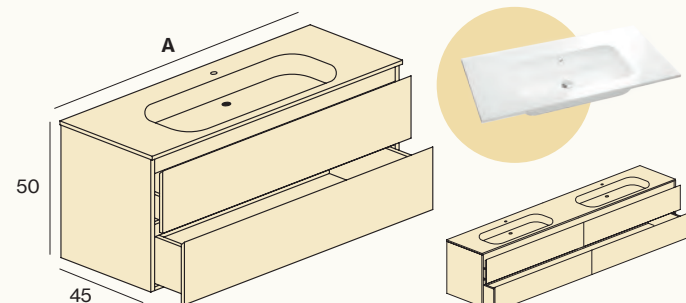

Blanco Mate

Sand

| A (cm) | LAVATÓRIO | BLANCO      | SAND        | PVP |
|--------|-----------|-------------|-------------|-----|
|        |           | REF         | REF         |     |
| 60     |           | S902.060.CB | S902.060.CS | -   |
| 80     |           | S902.080.CB | S902.080.CS | -   |
| 100    |           | S902.100.CB | S902.100.CS | -   |
| 120    |           | S902.120.CB | S902.120.CS | -   |
| 120X   |           | S902.120.XB | S902.120.XS | -   |

## 2 GAVETAS + TOPO SOLIDMINERAL (Mate)

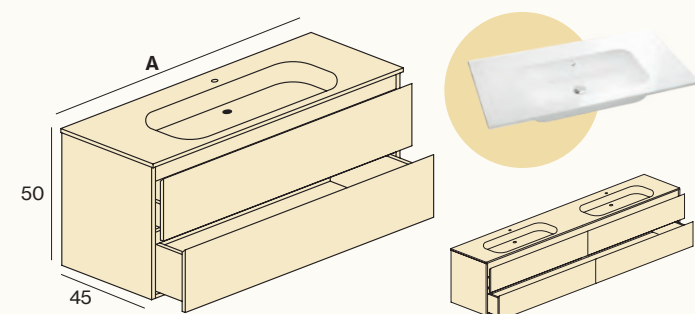

Blanco Mate

Sand

| A (cm) | LAVATÓRIO | BLANCO      | SAND        | PVP |
|--------|-----------|-------------|-------------|-----|
|        |           | REF         | REF         |     |
| 60     |           | S903.060.CB | S903.060.CS | -   |
| 80     |           | S903.080.CB | S903.080.CS | -   |
| 100    |           | S903.100.CB | S903.100.CS | -   |
| 120    |           | S903.120.CB | S903.120.CS | -   |
| 120X   |           | S903.120.XB | S903.120.XS | -   |



· Produto em estoque.



# 03

# Bancadas

Integrado, plano, lavatórios, soluções e materiais para cada necessidade.

## MATERIAIS

Para conhecer as características dos nossos materiais, para bancadas e lavatórios, consultar página 351.

## BANCADAS COM LAVATÓRIO INTEGRADO STANDARD

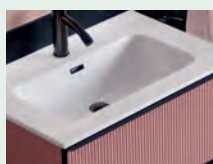
**Cerâmica**

pág. 262

**Glass Blanco**

pág. 263

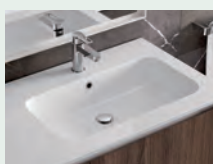
**Solid Mineral**

pág. 264

## BANCADAS COM LAVATÓRIO INTEGRADO A MEDIDA

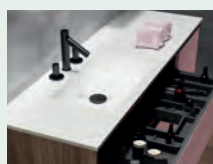
**Solid Mineral**

pág. 268

**Solid Surface**  eco

pág. 270

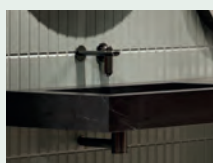
**Pedra Natural**

pág. 272

**Cristalcolor**

pág. 274

## LAVATÓRIO DE BANCADA

**Cerâmica /  
Ceramcolor**

pág. 276

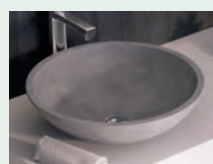
**Microcimento**

pág. 279

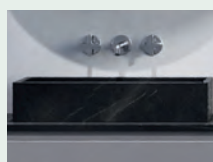
**Pedra Natural**

pág. 279

**Solid Surface**  eco

pág. 280

## TOTENS

**Solid Surface**  eco

pág. 283

## BANCADAS PLANAS

**Madeira Nature**

pág. 284

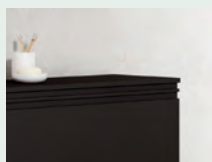
**Laca**

pág. 285

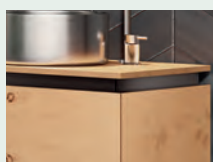
**Prancha  
Madeira Marinha**

pág. 286

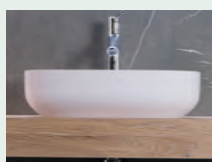
**Madeira  
Carvalho Maciça**

pág. 287

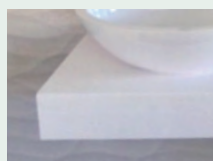
**Solid Mineral**

pág. 288

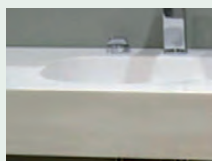
**Solid Surface**  eco

pág. 289

**Ceramcolor**

pág. 290

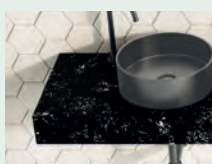
**Pedra Natural**

pág. 291

## ACESSÓRIOS DE BANCADA

**Suportes de Parede**

pág. 292

**Válvulas**

pág. 292

**Sifão Decorativo**

pág. 293

**Toalheiros**

pág. 293

**Bancada de Rodapé**

pág. 293

CERÂMICA

CERAMICS

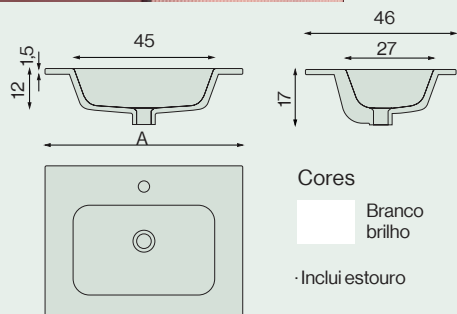

POSIÇÃO DE LAVATÓRIO

A (cm) E (cm)

REF

PVP

CENTRADO

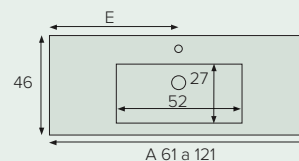

|     |    |          |   |
|-----|----|----------|---|
| 61  | 30 | EC.061.C | - |
| 71  | 35 | EC.071.C | - |
| 81  | 40 | EC.081.C | - |
| 91  | 45 | EC.091.C | - |
| 101 | 50 | EC.101.C | - |
| 121 | 60 | EC.121.C | - |

DIREITO

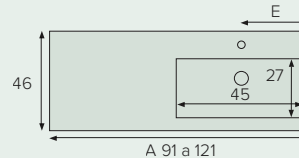

|     |    |          |   |
|-----|----|----------|---|
| 91  | 30 | EC.091.D | - |
| 101 | 35 | EC.101.D | - |
| 121 | 30 | EC.121.D | - |

DEIXOU

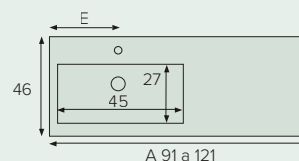

|     |    |          |   |
|-----|----|----------|---|
| 91  | 30 | EC.091.I | - |
| 101 | 35 | EC.101.I | - |
| 121 | 40 | EC.121.I | - |

DUPLO

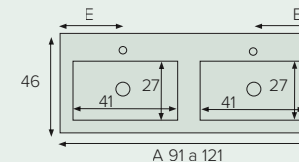

|     |    |          |   |
|-----|----|----------|---|
| 121 | 30 | EC.121.X | - |
| 141 | 35 | EC.141.X | - |

CERAMICS Fund 39

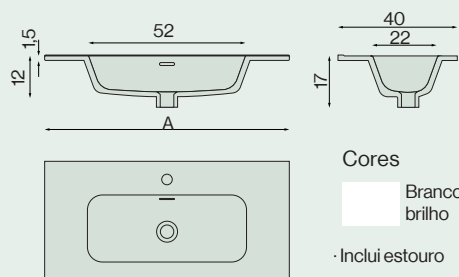

POSIÇÃO DE LAVATÓRIO

A (cm) E (cm)

REF

PVP

CENTRADO

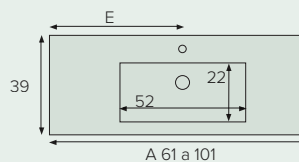

|     |    |          |   |
|-----|----|----------|---|
| 61  | 30 | EC.061.R | - |
| 71  | 35 | EC.071.R | - |
| 81  | 45 | EC.081.R | - |
| 101 | 50 | EC.101.R | - |

### GLASS BLANCO

### GLASS BLANCO

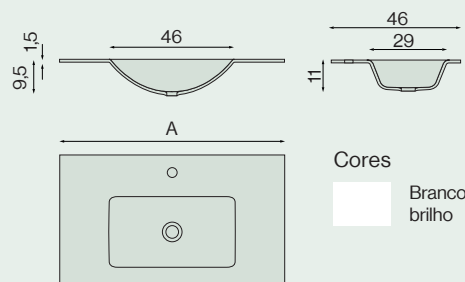

### POSIÇÃO DE LAVATÓRIO A (cm) E (cm) REF PVP

#### CENTRADO

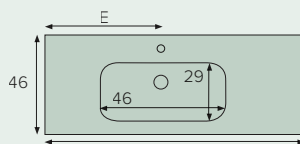

|            |    |          |   |
|------------|----|----------|---|
| <b>61</b>  | 30 | EL.061.C | - |
| <b>71</b>  | 35 | EL.071.C | - |
| <b>81</b>  | 40 | EL.081.C | - |
| <b>91</b>  | 45 | EL.091.C | - |
| <b>101</b> | 50 | EL.101.C | - |
| <b>121</b> | 60 | EL.121.C | - |

#### DEIXOU

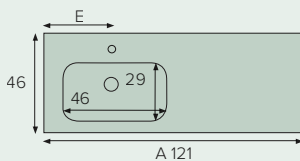

|            |    |          |   |
|------------|----|----------|---|
| <b>121</b> | 40 | EL.121.I | - |
|------------|----|----------|---|

#### DUPLO

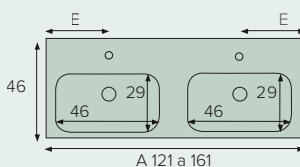

|            |    |          |   |
|------------|----|----------|---|
| <b>121</b> | 30 | EL.121.X | - |
| <b>141</b> | 35 | EL.141.X | - |
| <b>161</b> | 40 | EL.161.X | - |

#### e complementos

Válvulas e sifões  
página 292

### SOLID MINERAL

#### HARD

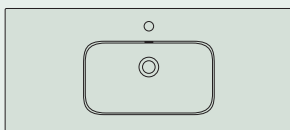
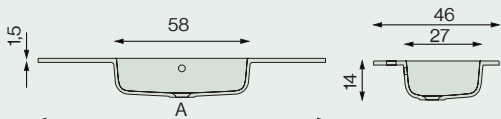

#### Cores

- Branco brilho
- Branco mate

· Inclui estouro

| POSIÇÃO DE LAVATÓRIO | A (cm) | E (cm) | Mate | Brilho | PVP |
|----------------------|--------|--------|------|--------|-----|
|----------------------|--------|--------|------|--------|-----|

#### CENTRADO

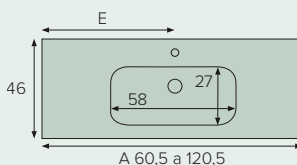

|       |    |           |           |   |
|-------|----|-----------|-----------|---|
| 60,5  | 30 | EH.061.CM | EH.061.CB | - |
| 70,5  | 35 | EH.071.CM | EH.071.CB | - |
| 80,5  | 40 | EH.081.CM | EH.081.CB | - |
| 90,5  | 45 | EH.091.CM | EH.091.CB | - |
| 100,5 | 50 | EH.101.CM | EH.101.CB | - |
| 120,5 | 60 | EH.121.CM | EH.121.CB | - |

#### DEIXOU

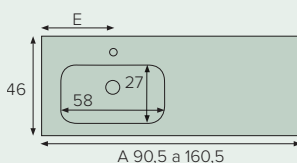

|       |    |           |           |   |
|-------|----|-----------|-----------|---|
| 90,5  | 30 | EH.091.IM | EH.091.IB | - |
| 100,5 | 30 | EH.101.IM | EH.101.IB | - |
| 120,5 | 40 | EH.121.IM | EH.121.IB | - |
| 140,5 | 35 | EH.141.IM | EH.141.IB | - |
| 160,5 | 40 | EH.161.IM | EH.161.IB | - |

#### DIREITO

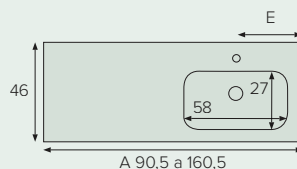

|       |    |           |           |   |
|-------|----|-----------|-----------|---|
| 90,5  | 30 | EH.091.DM | EH.091.DB | - |
| 100,5 | 30 | EH.101.DM | EH.101.DB | - |
| 120,5 | 40 | EH.121.DM | EH.121.DB | - |
| 140,5 | 35 | EH.141.DM | EH.141.DB | - |
| 160,5 | 40 | EH.161.DM | EH.161.DB | - |

#### DUPLO

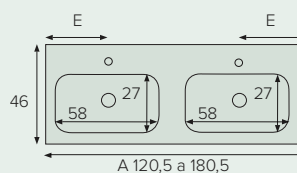

|       |    |           |           |   |
|-------|----|-----------|-----------|---|
| 120,5 | 30 | EH.121.XM | EH.121.XB | - |
| 140,5 | 35 | EH.141.XM | EH.141.XB | - |
| 160,5 | 40 | EH.161.XM | EH.161.XB | - |
| 180,5 | 45 | EH.181.XM | EH.181.XB | - |

· Para bancadas duplas de 60,5 e 120,5, a bacia tem 48,27 cm de largura

#### MUR

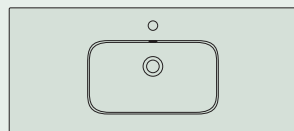
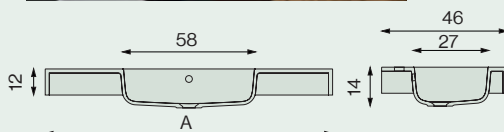

#### Cores

- Branco brilho
- Branco mate

· Suportes incluídos  
· Inclui estouro

| POSIÇÃO DE LAVATÓRIO | A (cm) | E (cm) | Mate | Brilho | PVP |
|----------------------|--------|--------|------|--------|-----|
|----------------------|--------|--------|------|--------|-----|

#### CENTRADO

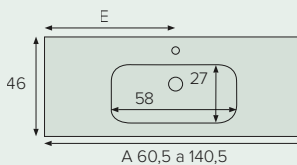

|       |    |           |           |   |
|-------|----|-----------|-----------|---|
| 60,5  | 30 | EM.061.CM | EM.061.CB | - |
| 70,5  | 35 | EM.071.CM | EM.071.CB | - |
| 80,5  | 40 | EM.081.CM | EM.081.CB | - |
| 90,5  | 45 | EM.091.CM | EM.091.CB | - |
| 100,5 | 50 | EM.101.CM | EM.101.CB | - |
| 120,5 | 60 | EM.121.CM | EM.121.CB | - |
| 140,5 | 60 | EM.141.CM | EM.141.CB | - |

#### DEIXOU

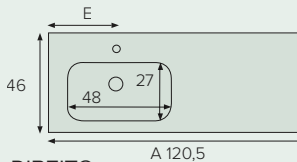

|       |    |           |           |   |
|-------|----|-----------|-----------|---|
| 120,5 | 30 | EM.121.IM | EM.121.IB | - |
|-------|----|-----------|-----------|---|

#### DIREITO

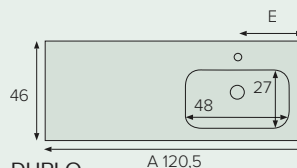

|       |    |           |           |   |
|-------|----|-----------|-----------|---|
| 120,5 | 30 | EM.121.DM | EM.121.DB | - |
|-------|----|-----------|-----------|---|

#### DUPLO

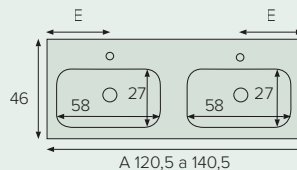

|       |    |           |           |   |
|-------|----|-----------|-----------|---|
| 120,5 | 30 | EM.121.XM | EM.121.XB | - |
| 140,5 | 35 | EM.141.XM | EM.141.XB | - |

· Para bancadas duplas de 60,5 e 120,5, a bacia tem 48,27 cm de largura



### SOLID MINERAL

#### PRISMA

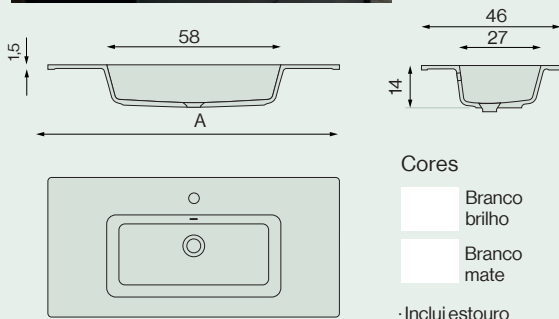

**Cores**  
 Branco brilho  
 Branco mate

· Inclui estouro

| POSIÇÃO DE LAVATÓRIO | A (cm) | E (cm) | Mate | Brilho | PVP |
|----------------------|--------|--------|------|--------|-----|
|----------------------|--------|--------|------|--------|-----|

#### CENTRADO

| A (cm) | E (cm) | Mate     | Brilho   | PVP |
|--------|--------|----------|----------|-----|
| 60,5   | 30     | EP061.CM | EP061.CB | -   |
| 80,5   | 40     | EP081.CM | EP081.CB | -   |
| 90,5   | 45     | EP091.CM | EP091.CB | -   |
| 100,5  | 50     | EP101.CM | EP101.CB | -   |
| 120,5  | 60     | EP121.CM | EP121.CB | -   |

#### DEIXOU

| A (cm) | E (cm) | Mate     | Brilho   | PVP |
|--------|--------|----------|----------|-----|
| 120,5  | 30     | EP121.IM | EP121.IB | -   |

#### DIREITO

| A (cm) | E (cm) | Mate     | Brilho   | PVP |
|--------|--------|----------|----------|-----|
| 120,5  | 30     | EP121.DM | EP121.DB | -   |

#### DUPLO

| A (cm) | E (cm) | Mate     | Brilho   | PVP |
|--------|--------|----------|----------|-----|
| 120,5  | 30     | EP121.XM | EP121.XB | -   |
| 140,5  | 35     | EP141.XM | EP141.XB | -   |

· Para bancadas duplas de 60,5 e 120,5, a bacia tem 4827 cm de largura

#### WALL

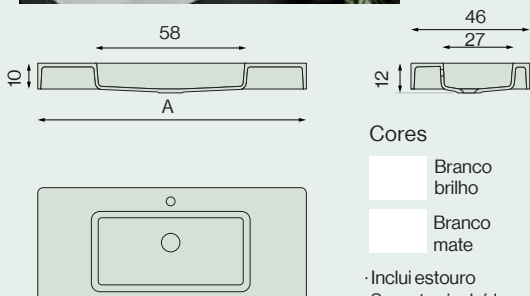

**Cores**  
 Branco brilho  
 Branco mate

· Inclui estouro  
 · Suportes incluídos

| POSIÇÃO DE LAVATÓRIO | A (cm) | E (cm) | Mate | Brilho | PVP |
|----------------------|--------|--------|------|--------|-----|
|----------------------|--------|--------|------|--------|-----|

#### CENTRADO

| A (cm) | E (cm) | Mate      | Brilho    | PVP |
|--------|--------|-----------|-----------|-----|
| 60,5   | 30     | EA.061.CM | EA.061.CB | -   |
| 80,5   | 40     | EA.081.CM | EA.081.CB | -   |
| 90,5   | 45     | EA.091.CM | EA.091.CB | -   |
| 100,5  | 50     | EA.101.CM | EA.101.CB | -   |
| 120,5  | 60     | EA.121.CM | EA.121.CB | -   |

#### DUPLO

| A (cm) | E (cm) | Mate     | Brilho   | PVP |
|--------|--------|----------|----------|-----|
| 120,5  | 30     | EA121.XM | EA121.XB | -   |
| 140,5  | 35     | EA141.XM | EA141.XB | -   |

· Para bancadas duplas de 60,5 e 120,5, a bacia tem 4827 cm de largura

#### e complementos

Válvulas e sifões  
 página 292

### SOLID MINERAL

#### WAVE

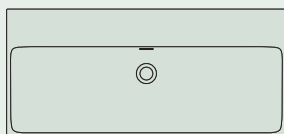
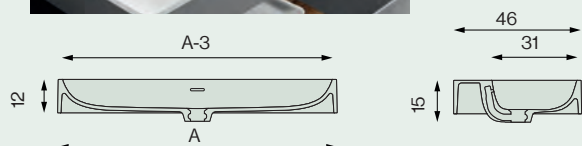

#### Cores

- Branco brilho
- Branco mate

| POSIÇÃO DE LAVATÓRIO | A (cm) | E (cm) | Mate | Brilho | PVP |
|----------------------|--------|--------|------|--------|-----|
|----------------------|--------|--------|------|--------|-----|

#### CENTRADO

|  |       |    |           |           |   |
|--|-------|----|-----------|-----------|---|
|  | 60,5  | 30 | EW.061.CM | EW.061.CB | - |
|  | 70,5  | 35 | EW.071.CM | EW.071.CB | - |
|  | 80,5  | 40 | EW.081.CM | EW.081.CB | - |
|  | 90,5  | 45 | EW.091.CM | EW.091.CB | - |
|  | 100,5 | 50 | EW.101.CM | EW.101.CB | - |

#### DUPLO

|  |       |    |           |           |   |
|--|-------|----|-----------|-----------|---|
|  | 120,5 | 30 | EW.121.XM | EW.121.XB | - |
|--|-------|----|-----------|-----------|---|

- Perfil de 1,5 cm de espessura
- Inclui estouro
- Inclui suportes de fixação de parede

#### THIN

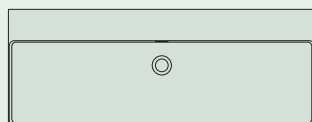
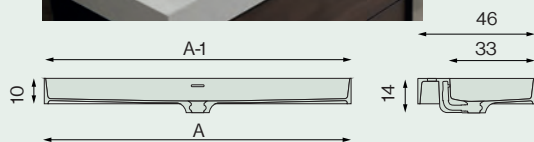
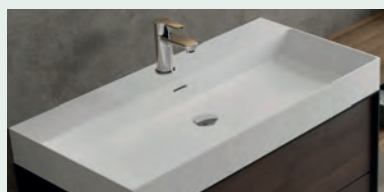
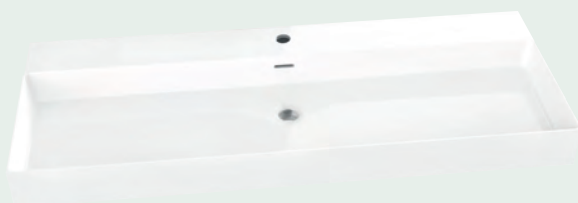

#### Cores

- Branco mate

| POSIÇÃO DE LAVATÓRIO | A (cm) | E (cm) | Mate | PVP |
|----------------------|--------|--------|------|-----|
|----------------------|--------|--------|------|-----|

#### CENTRADO

|  |       |    |           |   |
|--|-------|----|-----------|---|
|  | 60,5  | 30 | ET.061.CM | - |
|  | 70,5  | 35 | ET.071.CM | - |
|  | 80,5  | 40 | ET.081.CM | - |
|  | 90,5  | 45 | ET.091.CM | - |
|  | 100,5 | 50 | ET.101.CM | - |
|  | 120,5 | 60 | ET.121.CM | - |

- Espessura do perfil 0,5cm
- Inclui estouro
- Inclui suportes de fixação de parede

### SOLID MINERAL

#### FLY

#### POSIÇÃO DE LAVATÓRIO A (cm) E (cm) Mate Brilho PVP

##### CENTRADO

| A (cm) | E (cm) | Mate      | Brilho    | PVP |
|--------|--------|-----------|-----------|-----|
| 60,5   | 30     | EF.061.CM | EF.061.CB | -   |
| 70,5   | 35     | EF.071.CM | EF.071.CB | -   |
| 80,5   | 40     | EF.081.CM | EF.081.CB | -   |
| 90,5   | 45     | EF.091.CM | EF.091.CB | -   |
| 100,5  | 50     | EF.101.CM | EF.101.CB | -   |
| 120,5  | 60     | EF.121.CM | EF.121.CB | -   |

##### DEIXOU

| A (cm) | E (cm) | Mate      | Brilho    | PVP |
|--------|--------|-----------|-----------|-----|
| 120,5  | 30     | EF.121.IM | EF.121.IB | -   |

##### DIREITO

| A (cm) | E (cm) | Mate      | Brilho    | PVP |
|--------|--------|-----------|-----------|-----|
| 120,5  | 30     | EF.121.DM | EF.121.DB | -   |

##### DUPLO

| A (cm) | E (cm) | Mate      | Brilho    | PVP |
|--------|--------|-----------|-----------|-----|
| 120,5  | 30     | EF.121.XM | EF.121.XB | -   |
| 140,5  | 35     | EF.141.XM | EF.141.XB | -   |

· Para bancada dupla 120,5 e lavatórios de 50,5 · 35 cm

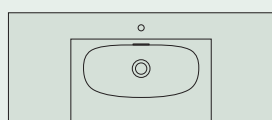
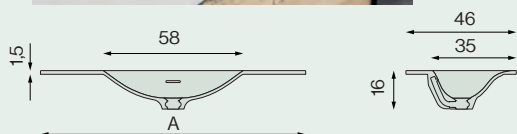

**Cores**  
 Branco brilho  
 Branco mate

#### HUG



· A bancada pode ser solicitada sem furo para torneira  
 · Outros designs especiais disponíveis

#### POSIÇÃO DE DECORATIVO A (cm) E (cm) Mate PVP

##### DIREITO

| A (cm) | E (cm) | Mate      | PVP |
|--------|--------|-----------|-----|
| 90     | 50     | EG.090.DM | -   |
| 110    | 60     | EG.110.DM | -   |
| 130    | 70     | EG.130.DM | -   |

##### DEIXOU

| A (cm) | E (cm) | Mate      | PVP |
|--------|--------|-----------|-----|
| 90     | 50     | EG.090.IM | -   |
| 110    | 60     | EG.110.IM | -   |
| 130    | 70     | EG.130.IM | -   |

**Cores**  
 Branco mate

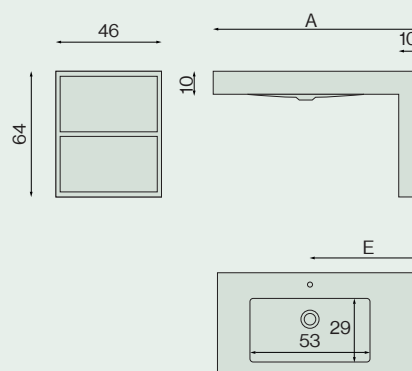

#### e complementos

Válvulas e sifões  
 página 292

### SOLID MINERAL

Material composto por cargas minerais e resinas de metacrílico de alta resistência. Não poroso e muito sedoso ao toque.

PERSONALIZE E CONFIGURE PERSONALIZADO - Escolha o tamanho e a espessura e adicione o lavatório desejado



Cores

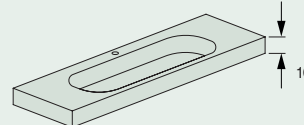
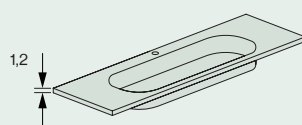
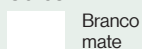

| POSIÇÃO DE LAVATÓRIO | A (cm) | E (cm)    | REF       | PVP       | REF       | PVP |
|----------------------|--------|-----------|-----------|-----------|-----------|-----|
| <b>CENTRADO</b>      |        |           |           |           |           |     |
|                      | 61     | 30        | ES.061.CP | -         | ES.061.CM | -   |
|                      | 71     | 35        | ES.071.CP | -         | ES.071.CM | -   |
|                      | 81     | 40        | ES.081.CP | -         | ES.081.CM | -   |
|                      | 91     | 45        | ES.091.CP | -         | ES.091.CM | -   |
|                      | 101    | 50        | ES.101.CP | -         | ES.101.CM | -   |
|                      | 121    | 60        | ES.121.CP | -         | ES.121.CM | -   |
|                      | 141    | 70        | ES.141.CP | -         | ES.141.CM | -   |
|                      | 161    | 80        | ES.161.CP | -         | ES.161.CM | -   |
|                      | 181    | 90        | ES.181.CP | -         | ES.181.CM | -   |
| 201                  | 100    | ES.201.CP | -         | ES.201.CM | -         |     |
| <b>DEIXOU</b>        |        |           |           |           |           |     |
|                      | 91     | 30        | ES.091.IP | -         | ES.091.IM | -   |
|                      | 101    | 35        | ES.101.IP | -         | ES.101.IM | -   |
|                      | 121    | 40        | ES.121.IP | -         | ES.121.IM | -   |
|                      | 141    | 35        | ES.141.IP | -         | ES.141.IM | -   |
|                      | 161    | 40        | ES.161.IP | -         | ES.161.IM | -   |
| 181                  | 45     | ES.181.IP | -         | ES.181.IM | -         |     |
| 201                  | 50     | ES.201.IP | -         | ES.201.IM | -         |     |
| <b>DIREITO</b>       |        |           |           |           |           |     |
|                      | 91     | 30        | ES.091.DP | -         | ES.091.DM | -   |
|                      | 101    | 35        | ES.101.DP | -         | ES.101.DM | -   |
|                      | 121    | 40        | ES.121.DP | -         | ES.121.DM | -   |
|                      | 141    | 35        | ES.141.DP | -         | ES.141.DM | -   |
|                      | 161    | 40        | ES.161.DP | -         | ES.161.DM | -   |
| 181                  | 45     | ES.181.DP | -         | ES.181.DM | -         |     |
| 201                  | 50     | ES.201.DP | -         | ES.201.DM | -         |     |
| <b>DUPLO</b>         |        |           |           |           |           |     |
|                      | 121    | 30        | ES.121.XP | -         | ES.121.XM | -   |
|                      | 141    | 35        | ES.141.XP | -         | ES.141.XM | -   |
|                      | 161    | 40        | ES.161.XP | -         | ES.161.XM | -   |
|                      | 181    | 45        | ES.181.XP | -         | ES.181.XM | -   |
|                      | 201    | 50        | ES.201.XP | -         | ES.201.XM | -   |



#### MEDIDAS ESPECIAIS

É possível fazer o pedido sem custo adicional:

- Larguras especiais. Preço da medida mais alta.
- Altura da saia de 5 a 10 cm.

#### FURO DE TORNEIRA

- É possível encomendar a placa sem furo para torneira.
- Poço da bacia conforme necessidade.
- Disponível com estouro.

#### e complementos

Válvulas e Sifões,  
Suportes de bancada,  
Toalheiros, Rodapés  
páginas 292-293

### LAVATÓRIOS A ESCOLHER

#### MINI



#### OBI



#### LIENA

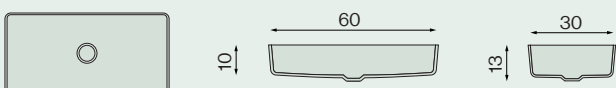

- Bancadas disponíveis a partir de 70 cm.
- Disponível com bancadas duplas a partir de 140 cm.

#### AMUR

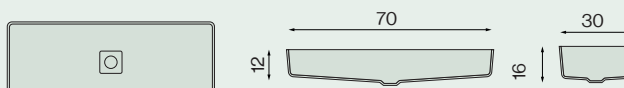

- Bancadas disponíveis a partir de 80 cm.
- Disponível com bancadas duplas a partir de 160 cm.

#### VOIGA

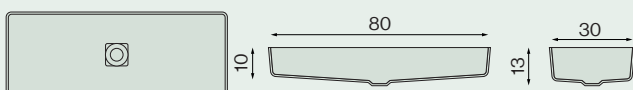

- Bancadas disponíveis a partir de 90 cm.
- Disponível com bancada dupla a partir de 180 cm.

#### SKYE



- Bancadas disponíveis a partir de 100 cm.
- Bancadas duplas não disponíveis

#### OVAL

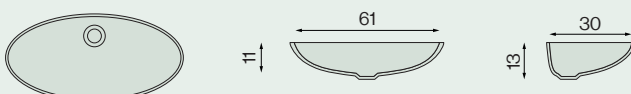

- Bancadas disponíveis a partir de 70 cm.
- Disponível com bancadas duplas a partir de 140 cm.

#### EXTRA KIT REBOARD



| REF  | PVP |
|------|-----|
| CE29 | -   |

SOLID SURFACE 

O Cristalplant é uma superfície sólida composta por cargas minerais e resinas de base biológica. Material não poroso, antibacteriano e toque sedoso.

**PERSONALIZE E CONFIGURE PERSONALIZADO** - Escolha o tamanho e a espessura e adicione a pia desejada



Cores

 Branco mate

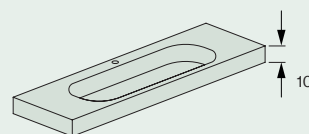
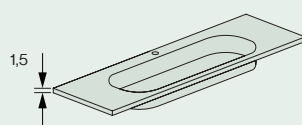

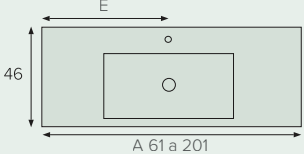
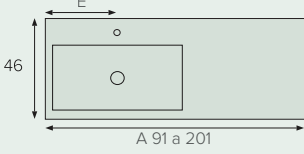
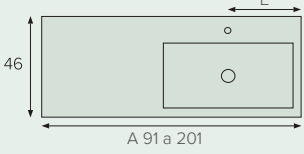
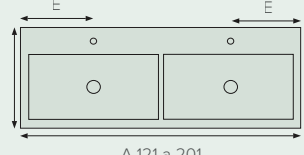
| POSIÇÃO DE LAVATÓRIO  | A (cm) | E (cm)    | REF       | PVP       | REF       | PVP |
|---|--------|-----------|-----------|-----------|-----------|-----|
| <b>CENTRADO</b>   |        |           |           |           |           |     |
|  | 61     | 30        | EJ.061.CP | -         | EJ.061.CM | -   |
|   | 71     | 35        | EJ.071.CP | -         | EJ.071.CM | -   |
|   | 81     | 40        | EJ.081.CP | -         | EJ.081.CM | -   |
|   | 91     | 45        | EJ.091.CP | -         | EJ.091.CM | -   |
|   | 101    | 50        | EJ.101.CP | -         | EJ.101.CM | -   |
|   | 121    | 60        | EJ.121.CP | -         | EJ.121.CM | -   |
|   | 141    | 70        | EJ.141.CP | -         | EJ.141.CM | -   |
|   | 161    | 80        | EJ.161.CP | -         | EJ.161.CM | -   |
| 181   | 90     | EJ.181.CP | -         | EJ.181.CM | -         |     |
| 201   | 100    | EJ.201.CP | -         | EJ.201.CM | -         |     |
| <b>DEIXOU</b>   |        |           |           |           |           |     |
|  | 91     | 30        | EJ.091.IP | -         | EJ.091.IM | -   |
|   | 101    | 35        | EJ.101.IP | -         | EJ.101.IM | -   |
|   | 121    | 40        | EJ.121.IP | -         | EJ.121.IM | -   |
|   | 141    | 35        | EJ.141.IP | -         | EJ.141.IM | -   |
|   | 161    | 40        | EJ.161.IP | -         | EJ.161.IM | -   |
| 181   | 45     | EJ.181.IP | -         | EJ.181.IM | -         |     |
| 201   | 50     | EJ.201.IP | -         | EJ.201.IM | -         |     |
| <b>DIREITO</b>  |        |           |           |           |           |     |
|  | 91     | 30        | EJ.091.DP | -         | EJ.091.DM | -   |
|   | 101    | 35        | EJ.101.DP | -         | EJ.101.DM | -   |
|   | 121    | 40        | EJ.121.DP | -         | EJ.121.DM | -   |
|   | 141    | 35        | EJ.141.DP | -         | EJ.141.DM | -   |
|   | 161    | 40        | EJ.161.DP | -         | EJ.161.DM | -   |
| 181   | 45     | EJ.181.DP | -         | EJ.181.DM | -         |     |
| 201   | 50     | EJ.201.DP | -         | EJ.201.DM | -         |     |
| <b>DUPLO</b>  |        |           |           |           |           |     |
|  | 121    | 30        | EJ.121.XP | -         | EJ.121.XM | -   |
|   | 141    | 35        | EJ.141.XP | -         | EJ.141.XM | -   |
|   | 161    | 40        | EJ.161.XP | -         | EJ.161.XM | -   |
|   | 181    | 45        | EJ.181.XP | -         | EJ.181.XM | -   |
|   | 201    | 50        | EJ.201.XP | -         | EJ.201.XM | -   |



### MEDIDAS ESPECIAIS

É possível fazer o pedido sem custo adicional:

- Larguras especiais. Preço da medida mais alta.
- Altura da saia de 5 a 10 cm.

### FURO DE TORNEIRA

- É possível encomendar a placa sem furo para torneira.
- Poço da bacia conforme necessidade.
- Disponível com estouro.

### e complementos

Válvulas e Sifões,  
Suportes de bancada,  
Toalheiros, Rodapés  
páginas 292-293

### LAVATÓRIOS A ESCOLHER

#### VICTORIA

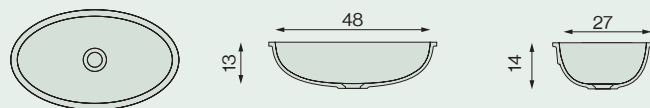

#### ONTARIO

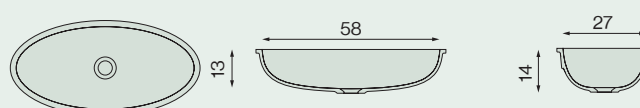

- Bancadas disponíveis a partir de 70 cm.
- Disponível com bancadas duplas a partir de 140 cm.

#### BAIKAL

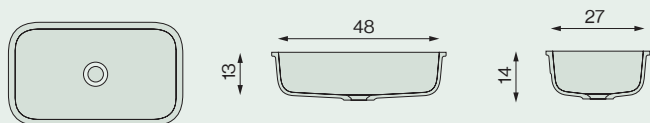

#### NYASSA

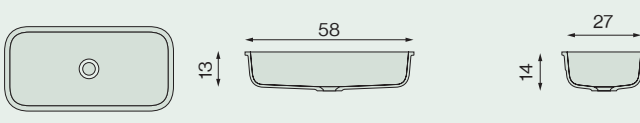

- Bancadas disponíveis a partir de 70 cm.
- Disponível com bancadas duplas a partir de 140 cm.

#### NESS

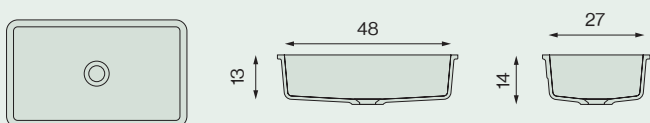

#### ERIE

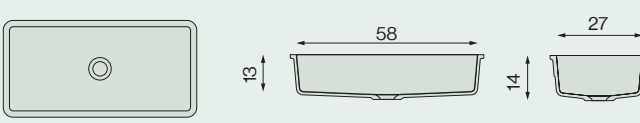

- Bancadas disponíveis a partir de 70 cm.
- Disponível com bancadas duplas a partir de 140 cm.

#### NASSER

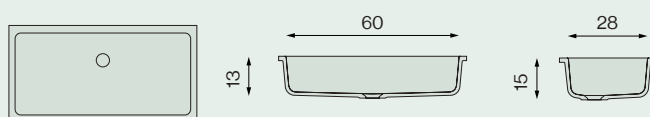

- Bancadas disponíveis a partir de 70 cm.
- Disponível com bancadas duplas a partir de 140 cm.

#### EXTRA KIT REBOARD



| REF  | PVP |
|------|-----|
| CE30 | -   |

### PEDRA NATURAL

#### PERSONALIZE E CONFIGURE A MEDIDA

Escolha o tamanho e adicione a pia desejada.



Cores

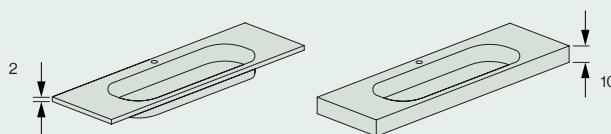
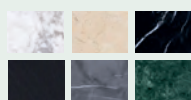

| POSIÇÃO DE LAVATÓRIO | A (cm) | E(cm) | REF       | PVP       | REF       | PVP |
|----------------------|--------|-------|-----------|-----------|-----------|-----|
| <b>CENTRADO</b>      |        |       |           |           |           |     |
|                      | 61     | 30    | EQ.061.CP | -         | EQ.061.CM | -   |
|                      | 71     | 35    | EQ.071.CP | -         | EQ.071.CM | -   |
|                      | 81     | 40    | EQ.081.CP | -         | EQ.081.CM | -   |
|                      | 91     | 45    | EQ.091.CP | -         | EQ.091.CM | -   |
|                      | 101    | 50    | EQ.101.CP | -         | EQ.101.CM | -   |
|                      | 121    | 60    | EQ.121.CP | -         | EQ.121.CM | -   |
|                      | 141    | 70    | EQ.141.CP | -         | EQ.141.CM | -   |
|                      | 161    | 80    | EQ.161.CP | -         | EQ.161.CM | -   |
|                      | 181    | 90    |           |           | EQ.181.CM | -   |
| 201                  | 100    |       |           | EQ.201.CM | -         |     |
| <b>DEIXOU</b>        |        |       |           |           |           |     |
|                      | 91     | 30    | EQ.091.IP | -         | EQ.091.IM | -   |
|                      | 101    | 35    | EQ.101.IP | -         | EQ.101.IM | -   |
|                      | 121    | 40    | EQ.121.IP | -         | EQ.121.IM | -   |
|                      | 141    | 35    | EQ.141.IP | -         | EQ.141.IM | -   |
|                      | 161    | 40    | EQ.161.IP | -         | EQ.161.IM | -   |
|                      | 181    | 45    |           |           | EQ.181.IM | -   |
| 201                  | 50     |       |           | EQ.201.IM | -         |     |
| <b>DIREITO</b>       |        |       |           |           |           |     |
|                      | 91     | 30    | EQ.091.DP | -         | EQ.091.DM | -   |
|                      | 101    | 35    | EQ.101.DP | -         | EQ.101.DM | -   |
|                      | 121    | 40    | EQ.121.DP | -         | EQ.121.DM | -   |
|                      | 141    | 35    | EQ.141.DP | -         | EQ.141.DM | -   |
|                      | 161    | 40    | EQ.161.DP | -         | EQ.161.DM | -   |
|                      | 181    | 45    |           |           | EQ.181.DM | -   |
| 201                  | 50     |       |           | EQ.201.DM | -         |     |
| <b>DUPLO</b>         |        |       |           |           |           |     |
|                      | 121    | 30    | EQ.121.XP | -         | EQ.121.XM | -   |
|                      | 141    | 35    | EQ.141.XP | -         | EQ.141.XM | -   |
|                      | 161    | 40    | EQ.161.XP | -         | EQ.161.XM | -   |
|                      | 181    | 45    | EQ.181.XP | -         | EQ.181.XM | -   |
|                      | 201    | 50    |           |           | EQ.201.XM | -   |



#### MEDIDAS ESPECIAIS

É possível fazer o pedido sem custo adicional:

- Larguras especiais. Preço da medida mais alta.
- Altura da saia de 5 a 10 cm.

#### FURO DE TORNEIRA

- É possível encomendar a placa sem furo para torneira.

#### e complementos

Válvulas e Sifões,  
Suportes de bancada,  
Toalheiros, Rodapés  
páginas 292-293



LAVATÓRIOS A ESCOLHER

PLUS

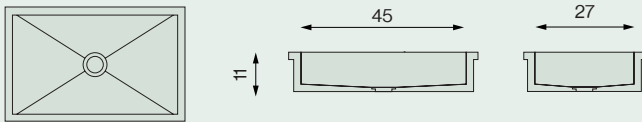

REGATA

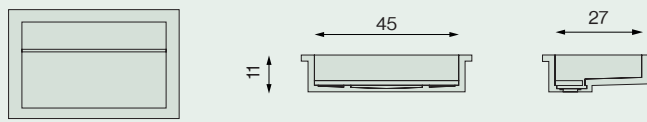

FALL

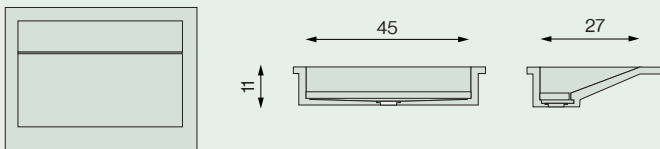

### CRISTALCOLOR

Vidro ótico transparente e vitrificado na cor desejada.

PERSONALIZE E CONFIGURE A MEDIDA - Escolha o tamanho e adicione o lavatório desejado



Cores

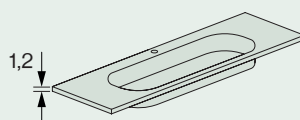

| POSIÇÃO DE LAVATÓRIO | A (cm) | E (cm) | REF | PVP |
|----------------------|--------|--------|-----|-----|
|----------------------|--------|--------|-----|-----|

#### CENTRADO

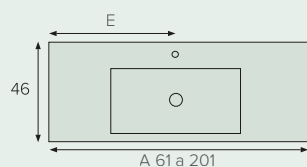

|     |     |           |   |
|-----|-----|-----------|---|
| 61  | 30  | EK.061.CP | - |
| 71  | 35  | EK.071.CP | - |
| 81  | 40  | EK.081.CP | - |
| 91  | 45  | EK.091.CP | - |
| 101 | 50  | EK.101.CP | - |
| 121 | 60  | EK.121.CP | - |
| 141 | 70  | EK.141.CP | - |
| 161 | 80  | EK.161.CP | - |
| 181 | 90  | EK.181.CP | - |
| 201 | 100 | EK.201.CP | - |

#### DEIXOU

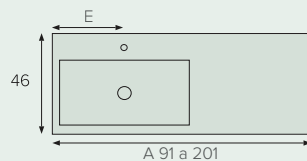

|     |    |           |   |
|-----|----|-----------|---|
| 91  | 30 | EK.091.IP | - |
| 101 | 35 | EK.101.IP | - |
| 121 | 40 | EK.121.IP | - |
| 141 | 35 | EK.141.IP | - |
| 161 | 40 | EK.161.IP | - |
| 181 | 45 | EK.181.IP | - |
| 201 | 50 | EK.201.IP | - |

#### DIREITO

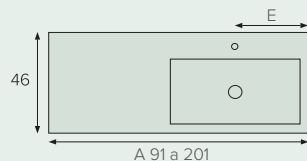

|     |    |           |   |
|-----|----|-----------|---|
| 91  | 30 | EK.091.DP | - |
| 101 | 35 | EK.101.DP | - |
| 121 | 40 | EK.121.DP | - |
| 141 | 35 | EK.141.DP | - |
| 161 | 40 | EK.161.DP | - |
| 181 | 45 | EK.181.DP | - |
| 201 | 50 | EK.201.DP | - |

#### DUPLO

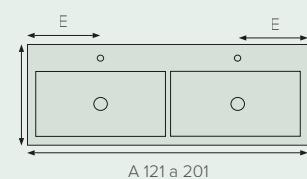

|     |    |           |   |
|-----|----|-----------|---|
| 141 | 35 | EK.141.XP | - |
| 161 | 45 | EK.161.XP | - |
| 181 | 45 | EK.181.XP | - |
| 201 | 50 | EK.201.XP | - |



#### MEDIDAS ESPECIAIS

É possível fazer o pedido sem custo adicional:

- Larguras especiais. Preço da medida mais alta.

#### FURO DE TORNEIRA

- É possível encomendar a placa sem furo para torneira.

#### COR ESPECIAL

- É possível solicitar cores especiais na tabela RAL.

#### e complementos

Válvulas e Sifões,  
página 292

LAVATÓRIOS A ESCOLHER

FLOW

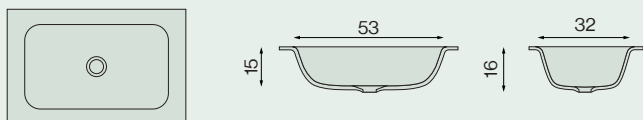

CANALE

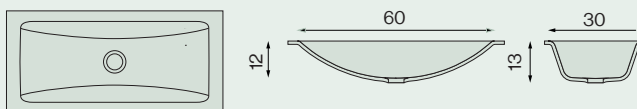

- Bancadas disponíveis a partir de 70 cm.
- Bancadas de pia dupla não disponíveis.

SEA

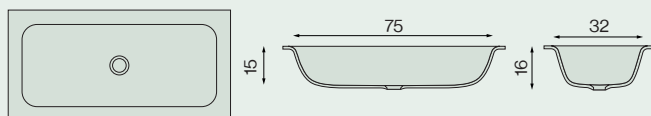

- Bancadas disponíveis a partir de 80 cm.
- Em pias duplas disponíveis em 180 e 200 cm.

CERÂMICA/ CERAMCOLOR

RECTÁNGULO



Cores

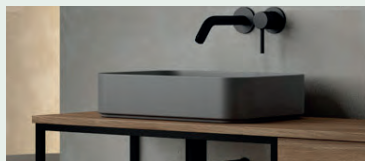

| COR            | REF   | PVP |
|----------------|-------|-----|
| Blanco Brilho  | LR.WB | -   |
| Blanco Mate    | LR.WM | -   |
| Negro Mate     | LR.BK | -   |
| Tierra Mate    | LR.TR | -   |
| Cuarzo Mate    | LR.CZ | -   |
| Acero Mate     | LR.AC | -   |
| Antracita Mate | LR.AN | -   |
| Oliva Mate     | LR.VO | -   |

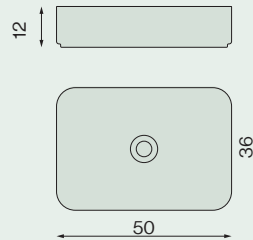

CUADRO



Cores



| COR            | REF   | PVP |
|----------------|-------|-----|
| Blanco Brilho  | LC.WB | -   |
| Blanco Mate    | LC.WM | -   |
| Negro Mate     | LC.BK | -   |
| Tierra Mate    | LC.TR | -   |
| Cuarzo Mate    | LCCZ  | -   |
| Acero Mate     | LC.AC | -   |
| Antracita Mate | LC.AN | -   |
| Oliva Mate     | LC.VO | -   |

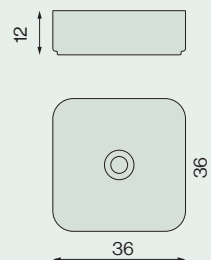

### CERAMIC/ CERAMCOLOR

#### SQUARE



Cores



| COR            | REF   | PVP |
|----------------|-------|-----|
| Blanco Brilho  | LS.WB | -   |
| Blanco Mate    | LS.WM | -   |
| Negro Mate     | LS.BK | -   |
| Tierra Mate    | LS.TR | -   |
| Cuarzo Mate    | LS.CZ | -   |
| Acero Mate     | LS.AC | -   |
| Antracita Mate | LS.AN | -   |
| Oliva Mate     | LS.VO | -   |

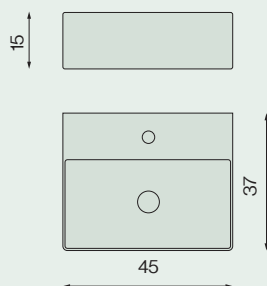

#### ÓVALO



Cores

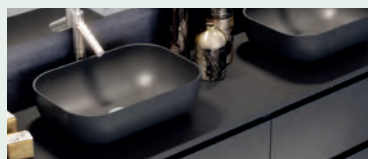

| COR            | REF   | PVP |
|----------------|-------|-----|
| Blanco Brilho  | LV.WB | -   |
| Blanco Mate    | LV.WM | -   |
| Negro Mate     | LV.BK | -   |
| Tierra Mate    | LV.TR | -   |
| Cuarzo Mate    | LVCZ  | -   |
| Acero Mate     | LV.AC | -   |
| Antracita Mate | LV.AN | -   |
| Oliva Mate     | LV.VO | -   |

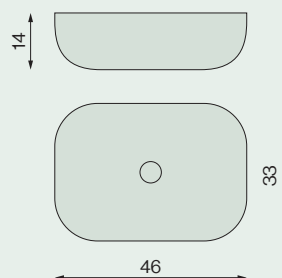

#### & complementa

Válvulas e Sifões,  
Bancadas planas  
página 292

CERAMIC/ CERAMCOLOR

CIRCUS



Cores



| COR            | REF  | PVP |
|----------------|------|-----|
| Blanco Brilho  | LUWB | -   |
| Blanco Mate    | LUWM | -   |
| Negro Mate     | LUBK | -   |
| Tierra Mate    | LUTR | -   |
| Cuarzo Mate    | LUCZ | -   |
| Acero Mate     | LUAC | -   |
| Antracita Mate | LUAN | -   |
| Oliva Mate     | LUVO | -   |

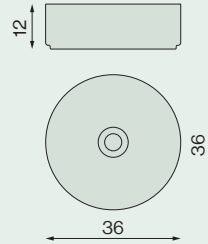

EYE



Cores



| COR            | REF  | PVP |
|----------------|------|-----|
| Blanco Mate    | LYWM | -   |
| Negro Mate     | LYBK | -   |
| Tierra Mate    | LYTR | -   |
| Cuarzo Mate    | LYCZ | -   |
| Acero Mate     | LYAC | -   |
| Antracita Mate | LYAN | -   |
| Oliva Mate     | LYVO | -   |

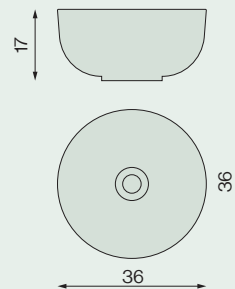

**MICROCIMENTO**

**CEMBOWL**

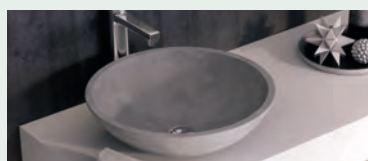

| COR | REF | PVP |
|-----|-----|-----|
|-----|-----|-----|

|              |    |   |
|--------------|----|---|
| Microcimento | LW | - |
|--------------|----|---|

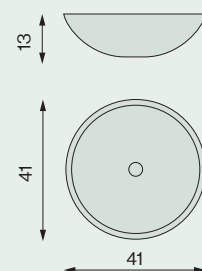

**PEDRA NATURAL**

**PIETRA**



Cores

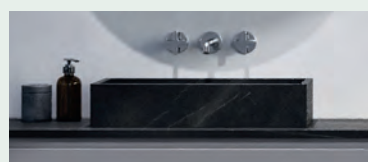
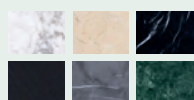

| COR | REF | PVP |
|-----|-----|-----|
|-----|-----|-----|

|                |       |   |
|----------------|-------|---|
| Negro Marquina | LT.N  | - |
| Carrara        | LTC   | - |
| Verde India    | LTV   | - |
| Negro Compacto | LT.NC | - |
| Crema Marfil   | LT.CM | - |
| Pietra Gris    | LT.PG | - |

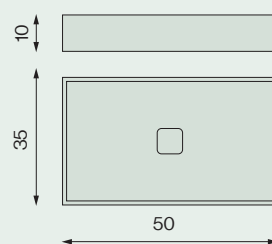

**& complementa**

Válvulas e Sifões,  
Bancadas planas  
tapas página 292

SOLID SURFACE 

### PRIM



Cores

 Branco mate



| A (cm) | REF    | PVP |
|--------|--------|-----|
| 48     | LK.048 | -   |
| 58     | LK.058 | -   |

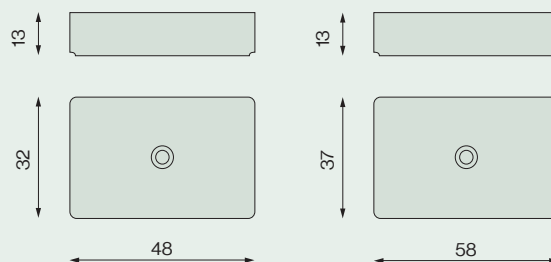

### QUADRA



Cores

 Branco mate



| COR  | REF | PVP |
|------|-----|-----|
| Mate | LD  | -   |

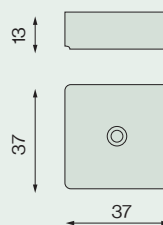

### CÍRCULO



Cores

 Branco mate



| COR  | REF | PVP |
|------|-----|-----|
| Mate | LF  | -   |

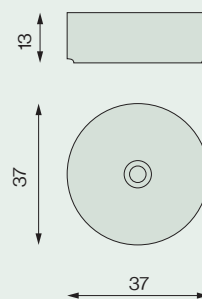



SOLID SURFACE 

**ROUND**



Cores

 Branco mate



**COR**

**REF**

**PVP**

Mate

LZ

-

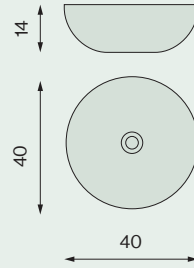

**ELÍPTICO**



Cores

 Branco mate



**COR**

**REF**

**PVP**

Mate

LH

-

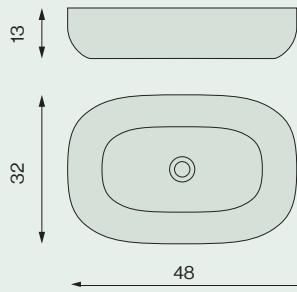

**MAX**



Cores

 Branco mate



**COR**

**REF**

**PVP**

Mate

LA

-

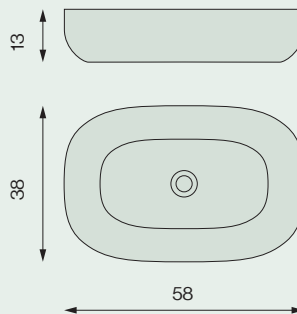

**& complementa**

Válvulas e Sifões,  
Bancadas planas  
tapas página 292

SOLID SURFACE 

COPA

| COR | REF | PVP |
|-----|-----|-----|
|-----|-----|-----|

|      |    |   |
|------|----|---|
| Mate | LG | - |
|------|----|---|



Cores  
 Branco mate

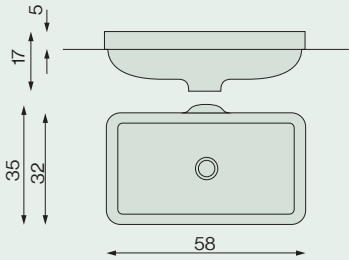

**& complementa**  
 Válvulas e Sifões,  
 Bancadas planas  
 tapas página 292

SOLID SURFACE 

### BALOON



#### POSIÇÃO

#### REF

#### PVP

|                 |      |   |
|-----------------|------|---|
| Dreno de chão*  | TB.S | - |
| Dreno de parede | TB.P | - |

\*inclui dreno de drenagem

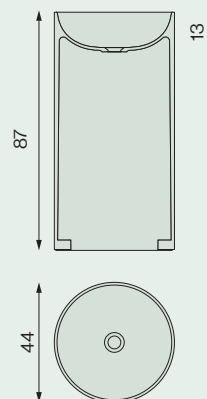

#### Cores

 Branco mate

### PILLAR



#### POSIÇÃO

#### REF

#### PVP

|                 |      |   |
|-----------------|------|---|
| Dreno de chão*  | TL.S | - |
| Dreno de parede | TL.P | - |

\*inclui dreno de drenagem

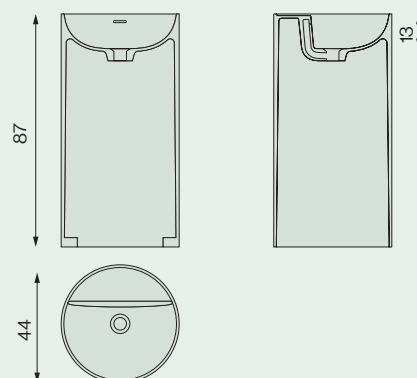

#### Cores

 Branco mate

### COLUMN



#### POSIÇÃO

#### REF

#### PVP

|                 |      |   |
|-----------------|------|---|
| Dreno de chão*  | TC.S | - |
| Dreno de parede | TC.P | - |

\*inclui dreno de drenagem

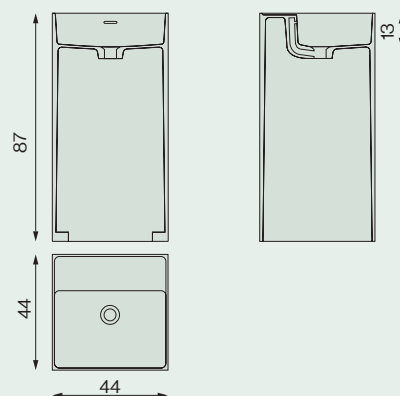

#### Cores

 Branco mate

### MADEIRA NATURE



#### Cores

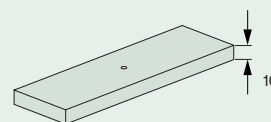
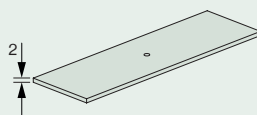
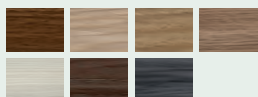

| POSIÇÃO DE LAVATÓRIO | A (cm)      | E(cm)      | REF       | PVP       | REF       | PVP       |   |
|----------------------|-------------|------------|-----------|-----------|-----------|-----------|---|
| <b>CENTRADO</b>      |             |            |           |           |           |           |   |
|                      | A 61 a 201  | <b>61</b>  | 30        | PN.061.CP | -         | PN.061.CM | - |
|                      |             | <b>71</b>  | 35        | PN.071.CP | -         | PN.071.CM | - |
|                      |             | <b>81</b>  | 40        | PN.081.CP | -         | PN.081.CM | - |
|                      |             | <b>91</b>  | 45        | PN.091.CP | -         | PN.091.CM | - |
|                      |             | <b>101</b> | 50        | PN.101.CP | -         | PN.101.CM | - |
|                      |             | <b>121</b> | 60        | PN.121.CP | -         | PN.121.CM | - |
|                      |             | <b>141</b> | 70        | PN.141.CP | -         | PN.141.CM | - |
|                      |             | <b>161</b> | 80        | PN.161.CP | -         | PN.161.CM | - |
|                      |             | <b>181</b> | 90        | PN.181.CP | -         | PN.181.CM | - |
|                      |             | <b>201</b> | 100       | PN.201.CP | -         | PN.201.CM | - |
| <b>DEIXOU</b>        |             |            |           |           |           |           |   |
|                      | A 91 a 201  | <b>91</b>  | 30        | PN.091.IP | -         | PN.091.IM | - |
|                      |             | <b>101</b> | 35        | PN.101.IP | -         | PN.101.IM | - |
|                      |             | <b>121</b> | 40        | PN.121.IP | -         | PN.121.IM | - |
|                      |             | <b>141</b> | 40        | PN.141.IP | -         | PN.141.IM | - |
|                      |             | <b>161</b> | 40        | PN.161.IP | -         | PN.161.IM | - |
|                      |             | <b>181</b> | 45        | PN.181.IP | -         | PN.181.IM | - |
| <b>DIREITO</b>       |             |            |           |           |           |           |   |
|                      | A 91 a 201  | <b>91</b>  | 30        | PN.091.DP | -         | PN.091.DM | - |
|                      |             | <b>101</b> | 35        | PN.101.DP | -         | PN.101.DM | - |
|                      |             | <b>121</b> | 40        | PN.121.DP | -         | PN.121.DM | - |
|                      |             | <b>141</b> | 40        | PN.141.DP | -         | PN.141.DM | - |
|                      |             | <b>161</b> | 40        | PN.161.DP | -         | PN.161.DM | - |
|                      |             | <b>181</b> | 45        | PN.181.DP | -         | PN.181.DM | - |
| <b>DUPLO</b>         |             |            |           |           |           |           |   |
|                      | A 121 a 201 | <b>121</b> | 30        | PN.121.XP | -         | PN.121.XM | - |
|                      |             | <b>141</b> | 35        | PN.141.XP | -         | PN.141.XM | - |
|                      |             | <b>161</b> | 40        | PN.161.XP | -         | PN.161.XM | - |
|                      |             | <b>181</b> | 45        | PN.181.XP | -         | PN.181.XM | - |
|                      | <b>201</b>  | 50         | PN.201.XP | -         | PN.201.XM | -         |   |



#### MEDIDAS ESPECIAIS

É possível fazer o pedido sem custo adicional:

- Larguras especiais. Preço da medida mais alta.
- Profundidade reduzida para 40 cm.
- Altura da saia de 5 a 10 cm.

#### FURO DE TORNEIRA

Pode ser pedido:

- Sem furo para pia e / ou torneira.
- Poço da bacia de acordo com a necessidade.
- Usinagem de lavatório especial fora de catálogo + € 50.

#### & complementa

Válvulas e Sifões,  
Suportes de bancada  
página 292

### LACA

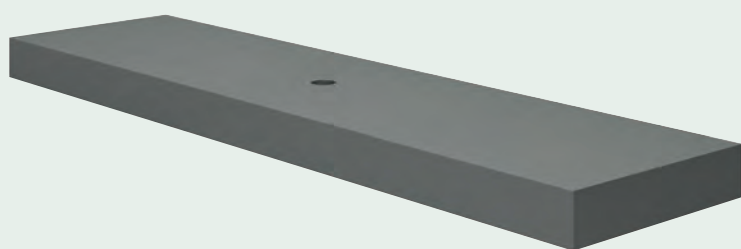
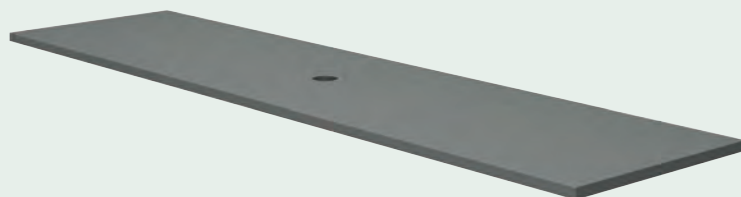

#### Cores

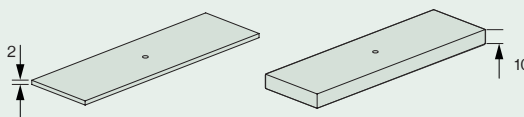

| POSIÇÃO DE LAVATÓRIO | A (cm)      | E(cm)      | REF       | PVP       | REF       | PVP       |   |
|----------------------|-------------|------------|-----------|-----------|-----------|-----------|---|
| <b>CENTRADO</b>      |             |            |           |           |           |           |   |
|                      | A 61 a 201  | <b>61</b>  | 30        | PL.061.CP | -         | PL.061.CM | - |
|                      |             | <b>71</b>  | 35        | PL.071.CP | -         | PL.071.CM | - |
|                      |             | <b>81</b>  | 40        | PL.081.CP | -         | PL.081.CM | - |
|                      |             | <b>91</b>  | 45        | PL.091.CP | -         | PL.091.CM | - |
|                      |             | <b>101</b> | 50        | PL.101.CP | -         | PL.101.CM | - |
|                      |             | <b>121</b> | 60        | PL.121.CP | -         | PL.121.CM | - |
|                      |             | <b>141</b> | 70        | PL.141.CP | -         | PL.141.CM | - |
|                      |             | <b>161</b> | 80        | PL.161.CP | -         | PL.161.CM | - |
|                      |             | <b>181</b> | 90        | PL.181.CP | -         | PL.181.CM | - |
|                      |             | <b>201</b> | 100       | PL.201.CP | -         | PL.201.CM | - |
| <b>DEIXOU</b>        |             |            |           |           |           |           |   |
|                      | A 91 a 201  | <b>91</b>  | 30        | PL.091.IP | -         | PL.091.IM | - |
|                      |             | <b>101</b> | 35        | PL.101.IP | -         | PL.101.IM | - |
|                      |             | <b>121</b> | 40        | PL.121.IP | -         | PL.121.IM | - |
|                      |             | <b>141</b> | 40        | PL.141.IP | -         | PL.141.IM | - |
|                      |             | <b>161</b> | 40        | PL.161.IP | -         | PL.161.IM | - |
|                      |             | <b>181</b> | 45        | PL.181.IP | -         | PL.181.IM | - |
| <b>DIREITO</b>       |             |            |           |           |           |           |   |
|                      | A 91 a 201  | <b>91</b>  | 30        | PL.091.DP | -         | PL.091.DM | - |
|                      |             | <b>101</b> | 35        | PL.101.DP | -         | PL.101.DM | - |
|                      |             | <b>121</b> | 40        | PL.121.DP | -         | PL.121.DM | - |
|                      |             | <b>141</b> | 40        | PL.141.DP | -         | PL.141.DM | - |
|                      |             | <b>161</b> | 40        | PL.161.DP | -         | PL.161.DM | - |
|                      |             | <b>181</b> | 45        | PL.181.DP | -         | PL.181.DM | - |
| <b>DUPLO</b>         |             |            |           |           |           |           |   |
|                      | A 121 a 201 | <b>121</b> | 30        | PL.121.XP | -         | PL.121.XM | - |
|                      |             | <b>141</b> | 40        | PL.141.XP | -         | PL.141.XM | - |
|                      |             | <b>161</b> | 40        | PL.161.XP | -         | PL.161.XM | - |
|                      |             | <b>181</b> | 45        | PL.181.XP | -         | PL.181.XM | - |
|                      | <b>201</b>  | 50         | PL.201.XP | -         | PL.201.XM | -         |   |



#### MEDIDAS ESPECIAIS

É possível fazer o pedido sem custo adicional:

- Larguras especiais. Preço da medida mais alta.
- Profundidade reduzida para 40 cm.
- Altura da saia de 5 a 10 cm.

#### FURO DE TORNEIRA

Pode ser pedido:

- Sem furo para pia e / ou torneira.
- Poço da bacia de acordo com a necessidade.
- Usinagem de lavatório especial fora de catálogo.

#### & complementa

Válvulas e Sifões,  
Suportes de bancada  
página 292

### PRANCHA MADEIRA MARINHA / Folheado de Carvalho e Nogueira



#### Cores

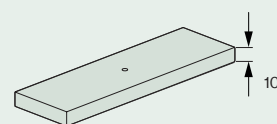
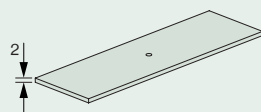
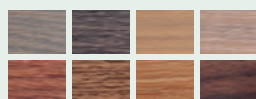

|                     | POSIÇÃO DE LAVATÓRIO | A (cm)     | E(cm) | REF       | PVP | REF       | PVP |   |
|---------------------|----------------------|------------|-------|-----------|-----|-----------|-----|---|
| <b>CENTRADO</b><br> |                      | <b>61</b>  | 30    | PT.061.CP | -   | PT.061.CM | -   | <b>MEDIDAS ESPECIAIS</b><br>É possível fazer o pedido sem custo adicional:<br>- Larguras especiais. Preço da medida mais alta.<br>- Profundidade reduzida para 40 cm.<br>- Altura da saia de 5 a 10 cm. |
|                     |                      | <b>71</b>  | 35    | PT.071.CP | -   | PT.071.CM | -   |   |
|                     |                      | <b>81</b>  | 40    | PT.081.CP | -   | PT.081.CM | -   |   |
|                     |                      | <b>91</b>  | 45    | PT.091.CP | -   | PT.091.CM | -   |   |
|                     |                      | <b>101</b> | 50    | PT.101.CP | -   | PT.101.CM | -   |   |
|                     |                      | <b>121</b> | 60    | PT.121.CP | -   | PT.121.CM | -   |   |
|                     |                      | <b>141</b> | 70    | PT.141.CP | -   | PT.141.CM | -   |   |
|                     |                      | <b>161</b> | 80    | PT.161.CP | -   | PT.161.CM | -   |   |
|                     |                      | <b>181</b> | 90    | PT.181.CP | -   | PT.181.CM | -   |   |
|                     |                      | <b>201</b> | 100   | PT.201.CP | -   | PT.201.CM | -   |   |
| <b>DEIXOU</b><br>   |                      | <b>91</b>  | 30    | PT.091.IP | -   | PT.091.IM | -   | <b>FURO DE TORNEIRA</b><br>Pode ser pedido:<br>- Sem furo para pia e / ou torneira<br>- Poço da bacia de acordo com a necessidade<br>- Usinagem de lavatório especial fora de catálogo                  |
|                     |                      | <b>101</b> | 35    | PT.101.IP | -   | PT.101.IM | -   |   |
|                     |                      | <b>121</b> | 40    | PT.121.IP | -   | PT.121.IM | -   |   |
|                     |                      | <b>141</b> | 40    | PT.141.IP | -   | PT.141.IM | -   |   |
|                     |                      | <b>161</b> | 40    | PT.161.IP | -   | PT.161.IM | -   |   |
|                     |                      | <b>181</b> | 45    | PT.181.IP | -   | PT.181.IM | -   |   |
| <b>DIREITO</b><br>  |                      | <b>91</b>  | 30    | PT.091.DP | -   | PT.091.DM | -   |   |
|                     |                      | <b>101</b> | 35    | PT.101.DP | -   | PT.101.DM | -   |   |
|                     |                      | <b>121</b> | 40    | PT.121.DP | -   | PT.121.DM | -   |   |
|                     |                      | <b>141</b> | 40    | PT.141.DP | -   | PT.141.DM | -   |   |
|                     |                      | <b>161</b> | 40    | PT.161.DP | -   | PT.161.DM | -   |   |
|                     |                      | <b>181</b> | 45    | PT.181.DP | -   | PT.181.DM | -   |   |
| <b>DUPLO</b><br>    |                      | <b>121</b> | 30    | PT.121.XP | -   | PT.121.XM | -   |   |
|                     |                      | <b>141</b> | 35    | PT.141.XP | -   | PT.141.XM | -   |   |
|                     |                      | <b>161</b> | 40    | PT.161.XP | -   | PT.161.XM | -   |   |
|                     |                      | <b>181</b> | 45    | PT.181.XP | -   | PT.181.XM | -   |   |
|                     |                      | <b>201</b> | 50    | PT.201.XP | -   | PT.201.XM | -   |   |



#### MEDIDAS ESPECIAIS

É possível fazer o pedido sem custo adicional:

- Larguras especiais. Preço da medida mais alta.
- Profundidade reduzida para 40 cm.
- Altura da saia de 5 a 10 cm.

#### FURO DE TORNEIRA

Pode ser pedido:

- Sem furo para pia e / ou torneira
- Poço da bacia de acordo com a necessidade
- Usinagem de lavatório especial fora de catálogo

#### & complementa

Válvulas e Sifões,  
Suportes de bancada  
página 292

### MADEIRA CARVALHO MACIÇA



#### Cores

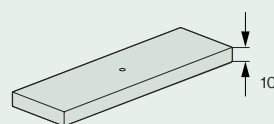
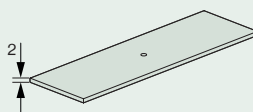

| POSIÇÃO DE LAVATÓRIO | A (cm) | E(cm)     | REF       | PVP       | REF       | PVP |   |
|----------------------|--------|-----------|-----------|-----------|-----------|-----|---|
| <b>CENTRADO</b>      |        |           |           |           |           |     | <p><b>MEDIDAS ESPECIAIS</b></p> <p>É possível fazer o pedido sem custo adicional:</p> <ul style="list-style-type: none"> <li>- Larguras especiais. Preço da medida mais alta.</li> <li>- Profundidade reduzida para 40 cm.</li> <li>- Altura da saia de 5 a 10 cm.</li> </ul> <p><b>FUO DE TORNEIRA</b></p> <p>Podem ser pedidos:</p> <ul style="list-style-type: none"> <li>- Sem furo para pia e / ou torneira</li> <li>- Poço da bacia de acordo com a necessidade</li> <li>- Usinagem de lavatório especial fora de catálogo</li> </ul> |
|                      | 61     | 30        | PZ.061.CP | -         | PZ.061.CM | -   |   |
|                      | 71     | 35        | PZ.071.CP | -         | PZ.071.CM | -   |   |
|                      | 81     | 40        | PZ.081.CP | -         | PZ.081.CM | -   |   |
|                      | 91     | 45        | PZ.091.CP | -         | PZ.091.CM | -   |   |
|                      | 101    | 50        | PZ.101.CP | -         | PZ.101.CM | -   |   |
|                      | 121    | 60        | PZ.121.CP | -         | PZ.121.CM | -   |   |
|                      | 141    | 70        | PZ.141.CP | -         | PZ.141.CM | -   |   |
|                      | 161    | 80        | PZ.161.CP | -         | PZ.161.CM | -   |   |
| 181                  | 90     | PZ.181.CP | -         | PZ.181.CM | -         |     |   |
| 201                  | 100    | PZ.201.CP | -         | PZ.201.CM | -         |     |   |
| <b>DEIXOU</b>        |        |           |           |           |           |     |   |
|                      | 91     | 30        | PZ.091.IP | -         | PZ.091.IM | -   |   |
|                      | 101    | 35        | PZ.101.IP | -         | PZ.101.IM | -   |   |
|                      | 121    | 40        | PZ.121.IP | -         | PZ.121.IM | -   |   |
|                      | 141    | 40        | PZ.141.IP | -         | PZ.141.IM | -   |   |
|                      | 161    | 40        | PZ.161.IP | -         | PZ.161.IM | -   |   |
|                      | 181    | 45        | PZ.181.IP | -         | PZ.181.IM | -   |   |
| <b>DIREITO</b>       |        |           |           |           |           |     |   |
|                      | 91     | 30        | PZ.091.DP | -         | PZ.091.DM | -   |   |
|                      | 101    | 35        | PZ.101.DP | -         | PZ.101.DM | -   |   |
|                      | 121    | 40        | PZ.121.DP | -         | PZ.121.DM | -   |   |
|                      | 141    | 40        | PZ.141.DP | -         | PZ.141.DM | -   |   |
|                      | 161    | 40        | PZ.161.DP | -         | PZ.161.DM | -   |   |
|                      | 181    | 45        | PZ.181.DP | -         | PZ.181.DM | -   |   |
| <b>DUPLO</b>         |        |           |           |           |           |     |   |
|                      | 121    | 30        | PZ.121.XP | -         | PZ.121.XM | -   |   |
|                      | 141    | 35        | PZ.141.XP | -         | PZ.141.XM | -   |   |
|                      | 161    | 40        | PZ.161.XP | -         | PZ.161.XM | -   |   |
|                      | 181    | 45        | PZ.181.XP | -         | PZ.181.XM | -   |   |
| 201                  | 50     | PZ.201.XP | -         | PZ.201.XM | -         |     |   |

#### & complementa

Válvulas e Sifões,  
Suportes de bancada  
página 292

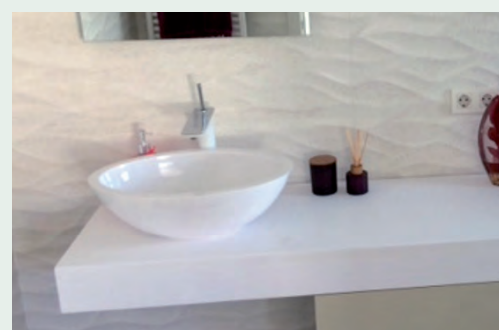

### SOLID MINERAL

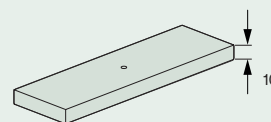
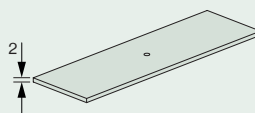

#### Cores

 Branco mate

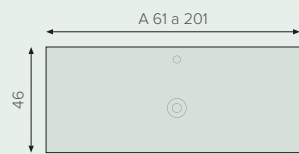
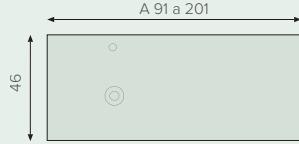
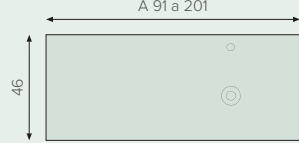

| POSIÇÃO DE LAVATÓRIO  | A (cm) | E(cm)     | REF       | PVP       | REF       | PVP |
|---|--------|-----------|-----------|-----------|-----------|-----|
| <b>CENTRADO</b>   |        |           |           |           |           |     |
|  | 61     | 30        | PS.061.CP | -         | PS.061.CM | -   |
|   | 71     | 35        | PS.071.CP | -         | PS.071.CM | -   |
|   | 81     | 40        | PS.081.CP | -         | PS.081.CM | -   |
|   | 91     | 45        | PS.091.CP | -         | PS.091.CM | -   |
|   | 101    | 50        | PS.101.CP | -         | PS.101.CM | -   |
|   | 121    | 60        | PS.121.CP | -         | PS.121.CM | -   |
|   | 141    | 70        | PS.141.CP | -         | PS.141.CM | -   |
|   | 161    | 80        | PS.161.CP | -         | PS.161.CM | -   |
|   | 181    | 90        | PS.181.CP | -         | PS.181.CM | -   |
|   | 201    | 100       | PS.201.CP | -         | PS.201.CM | -   |
| <b>DEIXOU</b>   |        |           |           |           |           |     |
|  | 91     | 30        | PS.091.IP | -         | PS.091.IM | -   |
|   | 101    | 35        | PS.101.IP | -         | PS.101.IM | -   |
|   | 121    | 40        | PS.121.IP | -         | PS.121.IM | -   |
|   | 141    | 40        | PS.141.IP | -         | PS.141.IM | -   |
|   | 161    | 40        | PS.161.IP | -         | PS.161.IM | -   |
|   | 181    | 45        | PS.181.IP | -         | PS.181.IM | -   |
| <b>DIREITO</b>  |        |           |           |           |           |     |
|  | 91     | 30        | PS.091.DP | -         | PS.091.DM | -   |
|   | 101    | 35        | PS.101.DP | -         | PS.101.DM | -   |
|   | 121    | 40        | PS.121.DP | -         | PS.121.DM | -   |
|   | 141    | 40        | PS.141.DP | -         | PS.141.DM | -   |
|   | 161    | 40        | PS.161.DP | -         | PS.161.DM | -   |
|   | 181    | 45        | PS.181.DP | -         | PS.181.DM | -   |
| <b>DUPLA</b>  |        |           |           |           |           |     |
|  | 121    | 30        | PS.121.XP | -         | PS.121.XM | -   |
|   | 141    | 35        | PS.141.XP | -         | PS.141.XM | -   |
|   | 161    | 40        | PS.161.XP | -         | PS.161.XM | -   |
|   | 181    | 45        | PS.181.XP | -         | PS.181.XM | -   |
| 201   | 50     | PS.201.XP | -         | PS.201.XM | -         |     |



#### MEDIDAS ESPECIAIS

É possível fazer o pedido sem custo adicional:

- Larguras especiais. Preço da medida mais alta.

- Profundidade reduzida para 40 cm.

- Altura da saia de 5 a 10 cm.

#### FURO DE TORNEIRA

Pode ser pedido:

- Sem furo para pia e / ou torneira

- Poço da bacia de acordo com a necessidade

- Usinagem de lavatório especial fora de catálogo

#### & complementa

Válvulas e Sifões, Suportes de bancada, Toalheiros, Rodapés páginas 292-293



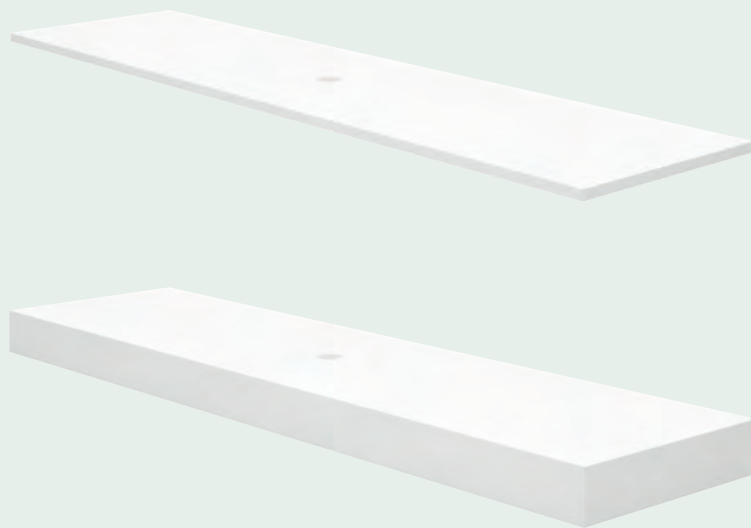

SOLID SURFACE 

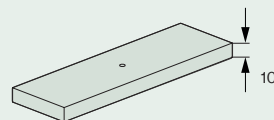
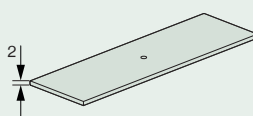

Cores

 Branco mate

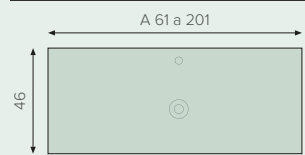
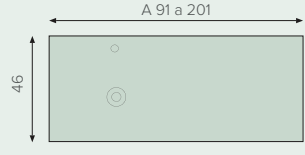
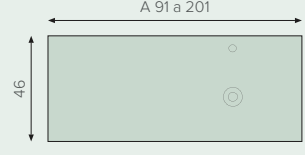

| POSIÇÃO DE LAVATÓRIO  | A (cm)     | E(cm) | REF       | PVP | REF       | PVP |
|---|------------|-------|-----------|-----|-----------|-----|
| <b>CENTRADO</b>   |            |       |           |     |           |     |
|  | <b>61</b>  | 30    | PJ.061.CP | -   | PJ.061.CM | -   |
|   | <b>71</b>  | 35    | PJ.071.CP | -   | PJ.071.CM | -   |
|   | <b>81</b>  | 40    | PJ.081.CP | -   | PJ.081.CM | -   |
|   | <b>91</b>  | 45    | PJ.091.CP | -   | PJ.091.CM | -   |
|   | <b>101</b> | 50    | PJ.101.CP | -   | PJ.101.CM | -   |
|   | <b>121</b> | 60    | PJ.121.CP | -   | PJ.121.CM | -   |
|   | <b>141</b> | 70    | PJ.141.CP | -   | PJ.141.CM | -   |
|   | <b>161</b> | 80    | PJ.161.CP | -   | PJ.161.CM | -   |
|   | <b>181</b> | 90    | PJ.181.CP | -   | PJ.181.CM | -   |
|   | <b>201</b> | 100   | PJ.201.CP | -   | PJ.201.CM | -   |
| <b>DEIXOU</b>   |            |       |           |     |           |     |
|  | <b>91</b>  | 30    | PJ.091.IP | -   | PJ.091.IM | -   |
|   | <b>101</b> | 35    | PJ.101.IP | -   | PJ.101.IM | -   |
|   | <b>121</b> | 40    | PJ.121.IP | -   | PJ.121.IM | -   |
|   | <b>141</b> | 40    | PJ.141.IP | -   | PJ.141.IM | -   |
|   | <b>161</b> | 40    | PJ.161.IP | -   | PJ.161.IM | -   |
|   | <b>181</b> | 45    | PJ.181.IP | -   | PJ.181.IM | -   |
| <b>DIREITO</b>  |            |       |           |     |           |     |
|  | <b>91</b>  | 30    | PJ.091.DP | -   | PJ.091.DM | -   |
|   | <b>101</b> | 35    | PJ.101.DP | -   | PJ.101.DM | -   |
|   | <b>121</b> | 40    | PJ.121.DP | -   | PJ.121.DM | -   |
|   | <b>141</b> | 40    | PJ.141.DP | -   | PJ.141.DM | -   |
|   | <b>161</b> | 40    | PJ.161.DP | -   | PJ.161.DM | -   |
|   | <b>181</b> | 45    | PJ.181.DP | -   | PJ.181.DM | -   |
| <b>DUPLO</b>  |            |       |           |     |           |     |
|  | <b>121</b> | 30    | PJ.121.XP | -   | PJ.121.XM | -   |
|   | <b>141</b> | 40    | PJ.141.XP | -   | PJ.141.XM | -   |
|   | <b>161</b> | 40    | PJ.161.XP | -   | PJ.161.XM | -   |
|   | <b>181</b> | 45    | PJ.181.XP | -   | PJ.181.XM | -   |
|   | <b>201</b> | 50    | PJ.201.XP | -   | PJ.201.XM | -   |



### MEDIDAS ESPECIAIS

É possível fazer o pedido sem custo adicional:

- Larguras especiais. Preço da medida mais alta.

- Profundidade reduzida para 40 cm.

- Altura da saia de 5 a 10 cm.

### FURO DE TORNEIRA

Pode ser pedido:

- Sem furo para pia e / ou torneira

- Poço da bacia de acordo com a necessidade

- Usinagem de lavatório especial fora de catálogo

### & complementa

Válvulas e Sifões, Suportes de bancada, Toalheiros, Rodapés páginas 292-293

### CERAMCOLOR

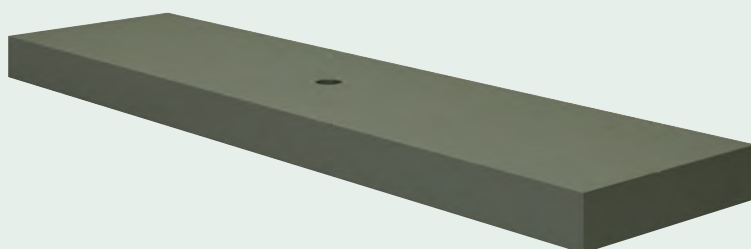
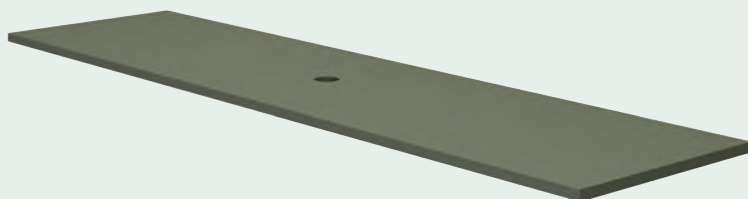

Cores Mate

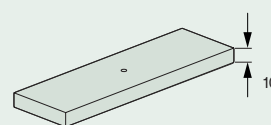
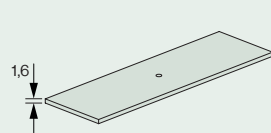

| POSIÇÃO DE LAVATÓRIO | A (cm)      | E(cm)     | REF       | PVP       | REF       | PVP |
|----------------------|-------------|-----------|-----------|-----------|-----------|-----|
| <b>CENTRADO</b>      |             |           |           |           |           |     |
|                      | A 61 a 201  |           |           |           |           |     |
|                      | 61          | 30        | PC.061.CP | -         | PC.061.CM | -   |
|                      | 71          | 35        | PC.071.CP | -         | PC.071.CM | -   |
|                      | 81          | 40        | PC.081.CP | -         | PC.081.CM | -   |
|                      | 91          | 45        | PC.091.CP | -         | PC.091.CM | -   |
|                      | 101         | 50        | PC.101.CP | -         | PC.101.CM | -   |
|                      | 121         | 60        | PC.121.CP | -         | PC.121.CM | -   |
|                      | 141         | 70        | PC.141.CP | -         | PC.141.CM | -   |
|                      | 161         | 80        | PC.161.CP | -         | PC.161.CM | -   |
|                      | 181         | 90        | PC.181.CP | -         | PC.181.CM | -   |
| 201                  | 100         | PC.201.CP | -         | PC.201.CM | -         |     |
| <b>DEIXOU</b>        |             |           |           |           |           |     |
|                      | A 91 a 201  |           |           |           |           |     |
|                      | 91          | 30        | PC.091.IP | -         | PC.091.IM | -   |
|                      | 101         | 35        | PC.101.IP | -         | PC.101.IM | -   |
|                      | 121         | 40        | PC.121.IP | -         | PC.121.IM | -   |
|                      | 141         | 40        | PC.141.IP | -         | PC.141.IM | -   |
|                      | 161         | 40        | PC.161.IP | -         | PC.161.IM | -   |
|                      | 181         | 45        | PC.181.IP | -         | PC.181.IM | -   |
| 201                  | 50          | PC.201.IP | -         | PC.201.IM | -         |     |
| <b>DIREITO</b>       |             |           |           |           |           |     |
|                      | A 91 a 201  |           |           |           |           |     |
|                      | 91          | 30        | PC.091.DP | -         | PC.091.DM | -   |
|                      | 101         | 35        | PC.101.DP | -         | PC.101.DM | -   |
|                      | 121         | 40        | PC.121.DP | -         | PC.121.DM | -   |
|                      | 141         | 40        | PC.141.DP | -         | PC.141.DM | -   |
|                      | 161         | 40        | PC.161.DP | -         | PC.161.DM | -   |
|                      | 181         | 45        | PC.181.DP | -         | PC.181.DM | -   |
| 201                  | 50          | PC.201.DP | -         | PC.201.DM | -         |     |
| <b>DUPLO</b>         |             |           |           |           |           |     |
|                      | A 121 a 201 |           |           |           |           |     |
|                      | 121         | 30        | PC.121.XP | -         | PC.121.XM | -   |
|                      | 141         | 35        | PC.141.XP | -         | PC.141.XM | -   |
|                      | 161         | 40        | PC.161.XP | -         | PC.161.XM | -   |
|                      | 181         | 45        | PC.181.XP | -         | PC.181.XM | -   |
| 201                  | 50          | PC.201.XP | -         | PC.201.XM | -         |     |



#### MEDIDAS ESPECIAIS

É possível fazer o pedido sem custo adicional:

- Larguras especiais. Preço da medida mais alta.

- Profundidade reduzida para 40 cm.

- Altura da saia de 5 a 10 cm.

#### FUO DE TORNEIRA

Podem ser pedidos:

- Sem furo para pia e / ou torneira

- Poço da bacia de acordo com a necessidade

- Usinagem de lavatório especial fora de catálogo

#### & complementa

Válvulas e Sifões, Suportes de bancada página 292

### PEDRA NATURAL

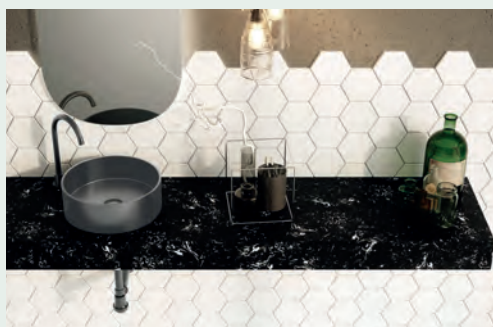
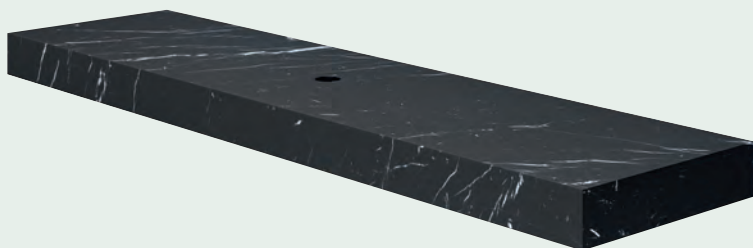
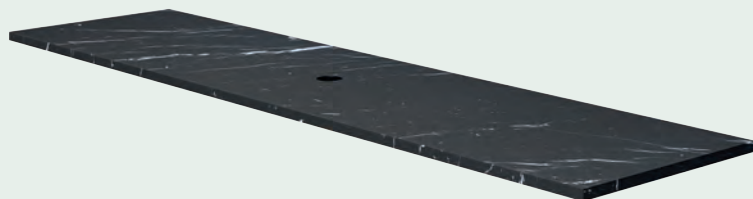

#### Cores

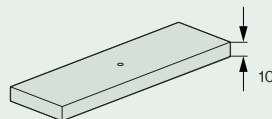
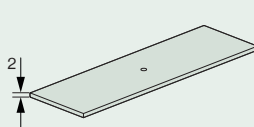
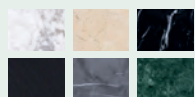

| POSIÇÃO DE LAVATÓRIO | A (cm)      | E(cm) | REF       | PVP       | REF       | PVP |
|----------------------|-------------|-------|-----------|-----------|-----------|-----|
| <b>CENTRADO</b>      |             |       |           |           |           |     |
|                      | A 61 a 201  |       |           |           |           |     |
|                      | 61          | 30    | PQ.061.CP | -         | PQ.061.CM | -   |
|                      | 71          | 35    | PQ.071.CP | -         | PQ.071.CM | -   |
|                      | 81          | 40    | PQ.081.CP | -         | PQ.081.CM | -   |
|                      | 91          | 45    | PQ.091.CP | -         | PQ.091.CM | -   |
|                      | 101         | 50    | PQ.101.CP | -         | PQ.101.CM | -   |
|                      | 121         | 60    | PQ.121.CP | -         | PQ.121.CM | -   |
|                      | 141         | 70    | PQ.141.CP | -         | PQ.141.CM | -   |
|                      | 161         | 80    | PQ.161.CP | -         | PQ.161.CM | -   |
|                      | 181         | 90    |           |           | PQ.181.CM | -   |
| 201                  | 100         |       |           | PQ.201.CM | -         |     |
| <b>DEIXOU</b>        |             |       |           |           |           |     |
|                      | A 91 a 201  |       |           |           |           |     |
|                      | 91          | 30    | PQ.091.IP | -         | PQ.091.IM | -   |
|                      | 101         | 35    | PQ.101.IP | -         | PQ.101.IM | -   |
|                      | 121         | 40    | PQ.121.IP | -         | PQ.121.IM | -   |
|                      | 141         | 40    | PQ.141.IP | -         | PQ.141.IM | -   |
|                      | 161         | 40    | PQ.161.IP | -         | PQ.161.IM | -   |
|                      | 181         | 45    |           |           | PQ.181.IM | -   |
| 201                  | 50          |       |           | PQ.201.IM | -         |     |
| <b>DIREITO</b>       |             |       |           |           |           |     |
|                      | A 91 a 201  |       |           |           |           |     |
|                      | 91          | 30    | PQ.091.DP | -         | PQ.091.DM | -   |
|                      | 101         | 35    | PQ.101.DP | -         | PQ.101.DM | -   |
|                      | 121         | 40    | PQ.121.DP | -         | PQ.121.DM | -   |
|                      | 141         | 40    | PQ.141.DP | -         | PQ.141.DM | -   |
|                      | 161         | 40    | PQ.161.DP | -         | PQ.161.DM | -   |
|                      | 181         | 45    |           |           | PQ.181.DM | -   |
| 201                  | 50          |       |           | PQ.201.DM | -         |     |
| <b>DUPLO</b>         |             |       |           |           |           |     |
|                      | A 121 a 201 |       |           |           |           |     |
|                      | 121         | 30    | PQ.121.XP | -         | PQ.121.XM | -   |
|                      | 141         | 40    | PQ.141.XP | -         | PQ.141.XM | -   |
|                      | 161         | 40    | PQ.161.XP | -         | PQ.161.XM | -   |
|                      | 181         | 45    | PQ.181.XP | -         | PQ.181.XM | -   |
|                      | 201         | 50    |           |           | PQ.201.XM | -   |



#### MEDIDAS ESPECIAIS

É possível fazer o pedido sem custo adicional:

- Larguras especiais. Preço da medida mais alta.

- Profundidade reduzida para 40 cm.

- Altura da saia de 5 a 10 cm.

#### FURO DE TORNEIRA

Pode ser pedido:

- Sem furo para pia e / ou torneira

- Poço da bacia de acordo com a necessidade

- Usinagem de lavatório especial fora de catálogo

#### & complementa

Válvulas e sifões, Suportes de bancada mural, Toalheiros, Rodapés bancada páginas 292-293

SUportes de Parede

SUportes de Fixação para Bancadas de Parede



1 unidades

150 Kg de carga

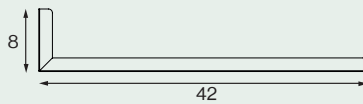

Cores



| REF  | PVP |
|------|-----|
| CE01 | -   |

Válvulas

Válvulas Basic



| COR            | REF  | PVP |
|----------------|------|-----|
| Cromada brilho | CE02 | -   |
| Branco mate    | CE03 | -   |
| Preto mate     | CE04 | -   |

Não compatível com sistema Decospace

Cores



Válvulas de Cerâmica



| COR            | REF  | PVP |
|----------------|------|-----|
| Blanco Mate    | CE05 | -   |
| Negro Mate     | CE06 | -   |
| Antracita Mate | CE07 | -   |
| Tierra Mate    | CE08 | -   |

Não compatível com sistema Decospace

Cores



Válvulas Sólidas



| MATERIAL      | REF  | PVP |
|---------------|------|-----|
| Solid Mineral | CE09 | -   |
| Solid Surface | CE10 | -   |

Não compatível com sistema Decospace

Cores



Tampa da Válvula de Espaço



| COR         | REF  | PVP |
|-------------|------|-----|
| Branco mate | CE11 | -   |
| Preto mate  | CE12 | -   |
| Ouro brilho | CE13 | -   |

Cores



SIFÃO DECORATIVO

SIFÃO DECORATIVO



| COR            | REF  | PVP |
|----------------|------|-----|
| Cromada brilho | CE14 | -   |
| Branco mate    | CE15 | -   |
| Preto mate     | CE16 | -   |

Cores



TOALHEIROS

RACK DE TOALHA DIANTEIRA (INTEGRADO)



| MATERIAL      | REF  | PVP |
|---------------|------|-----|
| Pedra Natural | CE17 | -   |
| Solid Mineral | CE18 | -   |
| Solid Surface | CE19 | -   |

Cores Pedra

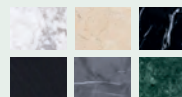

Cores



RACK DE TOALHA DO LADO SUPERIOR

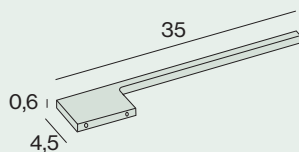

| COR              | REF    | PVP |
|------------------|--------|-----|
| Cromada brilho   | CM8.CB | -   |
| Preto mate       | CM8.BK | -   |
| Cor (carta laca) | CM8.CO | -   |

Cores



Cores Laca



PEITOS DE BANCADA



| A(cm)        | SOLID MINERAL |                    | SOLID SURFACE |                    | PEDRA NATURAL |                    |
|--------------|---------------|--------------------|---------------|--------------------|---------------|--------------------|
|              | REF           | PVP (metro linear) | REF           | PVP (metro linear) | REF           | PVP (metro linear) |
| De 40 a 100  | CE20          | -                  | CE23          | -                  | CE26          | -                  |
| De 100 a 160 | CE21          | -                  | CE24          | -                  | CE27          | -                  |
| De 160 a 200 | CE22          | -                  | CE25          | -                  | CE28          | -                  |

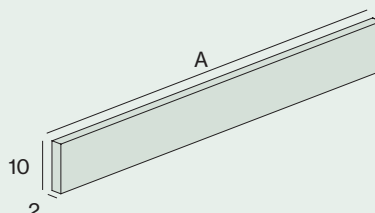

Cores Pedra

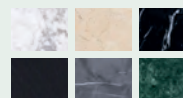

Cores







# 04 Espelhos

A fusão do espelho com a melhor tecnologia LED combina espelhos lisos, chanfrados e enquadrados de diferentes formatos para dar solução a cada projeto.

## LISOS

Grande variedade de espelhos essenciais com bordas brilhantes.

**Rectangular Liso**

pág. 300

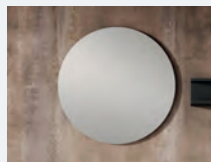
**Round Liso**

pág. 300

## LUZ DE FUNDO

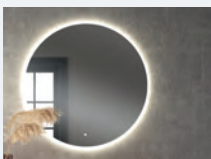
**Rounded**

pág. 301

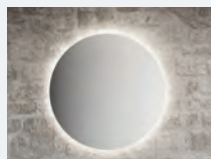
**Circled**

pág. 301

**Retroled**

pág. 302

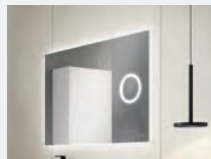
**Filed**

pág. 302

**Spinled**

pág. 303

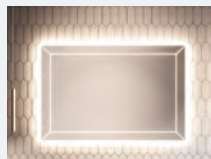
**Frameled**

pág. 303

## RETROILUMINAÇÃO FRONTAL

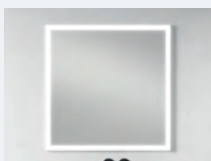
**Fronled**

pág. 304

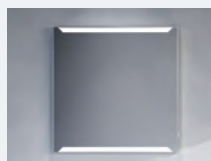
**Duoled**

pág. 304

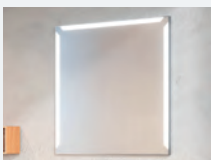
**Triled**

pág. 305

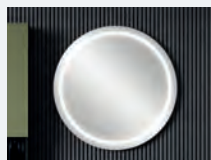
**Eyeled**

pág. 305



**ESTRUTURA DE METAL****Metalrounded**

pág. 306

**Metalsquareled**

pág. 306

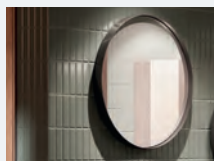
**Metalround**

pág. 307

**Metalsquare**

pág. 307

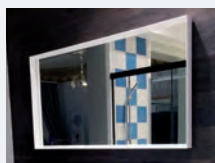
**MADEIRA EMOLDURADA****Corner**

pág. 308

**Luxor**

pág. 308

**ARMÁRIOS DE ESPELHO**

Roupeiro com portas de grande capacidade e funcionalidade, totalmente revestido a espelho

**Armário espelhado  
com uma porta**

pág. 309

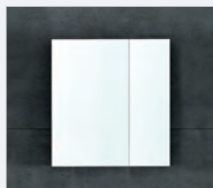
**Armário espelhado  
com duas portas**

pág. 309

**COMPLEMENTA O TEU ESPELHO**

Personaliza o teu espelho com opções como antivandálico, sensores, luzes, etc.

pág. 310

Cada uma das soluções pode ser personalizada.

Nossos produtos são certificados e compatíveis com Certificação CE e IP44 no caso de espelhos retroiluminados.

Todos os espelhos têm espessura de 4 mm com bordas polidas e são fornecidos com as ferragens necessárias ao seu posicionamento com ganchos ajustáveis.

Os espelhos lisos possuem acabamentos laterais em cromo polido e uma espuma anti-choque que permite uma perfeita adaptação à parede e evita as vibrações do espelho.

Os espelhos lisos podem ser equipados com o SAFE SYSTEM, que proporciona uma segurança extra que evita que uma peça caia em caso de quebra.

Espelhos com iluminação led.  
Consulte a página de informações técnicas de iluminação. pág. 317.

## Descubra as diferentes opções que a maioria dos espelhos oferece



### ESPELHOS COM ANTIEMBAÇANTE

É possível equipar o espelho com sistema antiembaçante. Uma película térmica aderida à parte posterior do espelho evita a condensação da água no espelho, melhorando o conforto de utilização e o reflexo perfeito do espelho.



### ESPELHOS COM LUZ FRIA OU QUENTE

Você pode personalizar seu espelho com a temperatura de cor desejada, mais quente ou mais fria, de 3000°k a 5500°K. Você pode até equipar seu espelho com um sensor de toque que permitirá alterar a temperatura da cor, seja ela quente, neutra ou fria.



### ESPELHOS COM SENSOR LIGADO DESLIGADO

Esta opção permitirá que você ligue / desligar o espelho e editar o arquivo intensidade da luz se necessário com leve pressão no sensor de toque.



### SISTEMA DE TELA COM SENSOR ON / OFF

A tecnologia nos permite replicar a tela do seu celular no espelho. Com isso, você pode espelhar facilmente no espelho todo o conteúdo do seu celular, como vídeos e fotos. Compatível com IOS e Android.



### ESPELHOS COM BLUETOOTH

Você pode conectar seu celular ao espelho via bluetooth e curtir sua música na casa de banho.



### SENSOR ANTIEMBAÇANTE

Sensor ON / OFF para tecido antiembaçante.



### ESPELHO DE AUMENTO

Você pode personalizar seu espelho com um espelho de aumento x5 integrado com iluminação LED de perímetro.

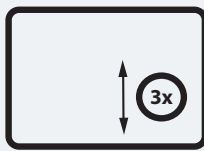

### ESPELHO DE AUMENTO MÓVEL

Você pode equipar o espelho com um espelho de aumento magnetizado x3 que permite colocá-lo na área habilitada do espelho e ajustar sua posição.

**RETANGULAR LISO: Padrão e medido**

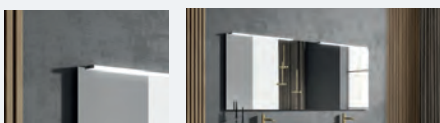

- Padrão básico: com placa de suspensão.
- Padrão garantido: espelho com sistema de segurança e laterais cromadas anti-choque.
- Sob medida securizado: espelho personalizado com sistema de segurança e laterais cromadas anti-choque.

| TIPOS                      | A (cm)    | H (cm)    | REF        | PVP |
|----------------------------|-----------|-----------|------------|-----|
| <b>Padrão básico</b>       |           |           |            |     |
| 60                         | 80        | 80        | SLB.06080  | -   |
| 70                         | 80        | 80        | SLB.07080  | -   |
| 80                         | 80        | 80        | SLB.08080  | -   |
| 90                         | 80        | 80        | SLB.09080  | -   |
| 100                        | 80        | 80        | SLB.10080  | -   |
| 120                        | 80        | 80        | SLB.12080  | -   |
| 140                        | 80        | 80        | SLB.14080  | -   |
| <b>Padrão garantido</b>    |           |           |            |     |
| 60                         | 80        | 80        | SLS.06080  | -   |
| 70                         | 80        | 80        | SLS.07080  | -   |
| 80                         | 80        | 80        | SLS.08080  | -   |
| 90                         | 80        | 80        | SLS.09080  | -   |
| 100                        | 80        | 80        | SLS.10080  | -   |
| 120                        | 80        | 80        | SLS.12080  | -   |
| 140                        | 80        | 80        | SLS.14080  | -   |
| <b>Cofre personalizado</b> |           |           |            |     |
| 60 a 80                    | 50 a 90   | 50 a 90   | SLM.08090  | -   |
| 81 a 100                   | 50 a 90   | 50 a 90   | SLM.10090  | -   |
| 101 a 120                  | 50 a 90   | 50 a 90   | SLM.12090  | -   |
| 121 a 140                  | 50 a 90   | 50 a 90   | SLM.14090  | -   |
| 141 a 160                  | 50 a 90   | 50 a 90   | SLM.16090  | -   |
| 161 a 180                  | 50 a 90   | 50 a 90   | SLM.18090  | -   |
| 181 a 200                  | 50 a 90   | 50 a 90   | SLM.20090  | -   |
| 40 a 60                    | 150 a 200 | 150 a 200 | SLM.040200 | -   |

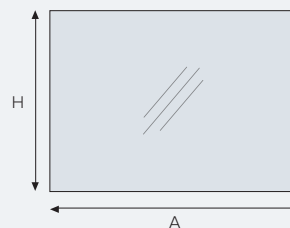

**& complementa**  
 Sistema Antiembaçante,  
 Sensor Antiembaçante,  
 Led 5X  
 página....310

**SMOOTH ROUND: Espelho redondo liso padrão**

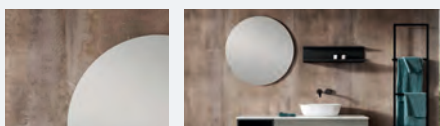

Cabides ajustáveis

| D (cm) | REF       | PVP |
|--------|-----------|-----|
| 60     | SR.06060  | -   |
| 70     | SR.07070  | -   |
| 80     | SR.08080  | -   |
| 90     | SR.09090  | -   |
| 100    | SR.100100 | -   |
| 120    | SR.120120 | -   |

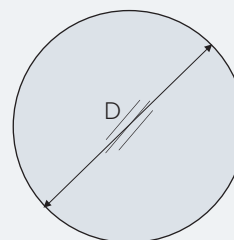

**ROUNDLED:** Retroiluminação lateral e moldura perimetral

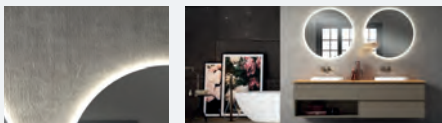

| LUZ | COR °K          | CONSUMO | POTÊNCIA                      | ESTADO |
|-----|-----------------|---------|-------------------------------|--------|
| LED | 5500K<br>Branco | 9.6W    | 960<br>LUMENS<br>metro linear | IP44   |

Personalize seus LEDs de 3000°K e 4200°K sem custo adicional. Standard de 5500°K.

| D (cm) | REF     | PVP |
|--------|---------|-----|
| 60     | SD.6060 | -   |
| 80     | SD.8080 | -   |

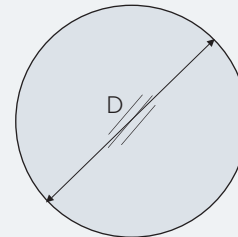

**& complementa**

Sensor On/Off,  
Sensor Antiembaçante,  
Sistema Antiembaçante  
página...310

**CIRCLED:** Luz de fundo do perímetro

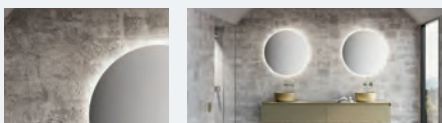

| LUZ | COR °K          | CONSUMO | POTÊNCIA                      | ESTADO |
|-----|-----------------|---------|-------------------------------|--------|
| LED | 5500K<br>Branco | 9.6W    | 960<br>LUMENS<br>metro linear | IP44   |

Personalize seus LEDs de 3000°K e 4200°K sem custo adicional. Standard de 5500°K.

| D (cm) | REF       | PVP |
|--------|-----------|-----|
| 60     | SC.06060  | -   |
| 70     | SC.07070  | -   |
| 80     | SC.08080  | -   |
| 90     | SC.09090  | -   |
| 100    | SC.100100 | -   |

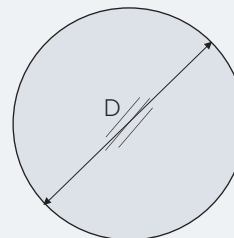

**& complementa**

Sensor On/Off,  
Sensor Antiembaçante,  
Sistema Antiembaçante  
página....310

**RETROLED:** Retroiluminação superior e inferior

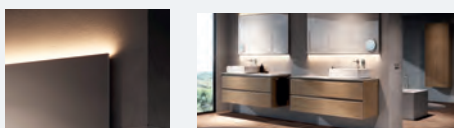

· Padrão e personalizado

|     |              |         |                         |        |
|-----|--------------|---------|-------------------------|--------|
| LUZ | COR °K       | CONSUMO | POTÊNCIA                | ESTADO |
| LED | 5500K Branco | 9.6W    | 960 LUMENS metro linear | IP44   |

Personalize seus LEDs de 3000°K e 4200°K sem custo adicional. Standard de 5500°K.

| TIPOS             | A (cm)  | H (cm) | REF      | PVP |
|-------------------|---------|--------|----------|-----|
| <b>Padrão</b>     |         |        |          |     |
| 60                | 80      | 80     | ST.06080 | -   |
| 80                | 80      | 80     | ST.08080 | -   |
| 100               | 80      | 80     | ST.10080 | -   |
| 120               | 80      | 80     | ST.12080 | -   |
| 140               | 80      | 80     | ST.14080 | -   |
| <b>Sob medida</b> |         |        |          |     |
| 60 a 80           | 50 a 72 | 72     | ST.08072 | -   |
| 81 a 100          | 50 a 72 | 72     | ST.10072 | -   |
| 101 a 120         | 50 a 72 | 72     | ST.12072 | -   |
| 121 a 140         | 50 a 72 | 72     | ST.14072 | -   |
| 141 a 160         | 50 a 72 | 72     | ST.16072 | -   |
| 161 a 180         | 50 a 72 | 72     | ST.18072 | -   |
| 181 a 200         | 50 a 72 | 72     | ST.20072 | -   |
| 60 a 80           | 73 a 90 | 90     | ST.08090 | -   |
| 81 a 100          | 73 a 90 | 90     | ST.10090 | -   |
| 101 a 120         | 73 a 90 | 90     | ST.12090 | -   |
| 121 a 140         | 73 a 90 | 90     | ST.14090 | -   |
| 141 a 160         | 73 a 90 | 90     | ST.16090 | -   |
| 161 a 180         | 73 a 90 | 90     | ST.18090 | -   |
| 181 a 200         | 73 a 90 | 90     | ST.20090 | -   |

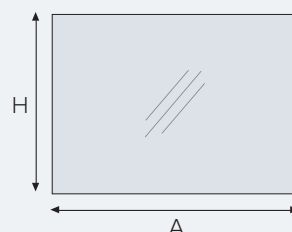

**& complementa**  
 Sistema antiembaçante,  
 Led 5X,  
 Sensor On/Off,  
 Sensor de Cor  
 Sensor Bluetooth,  
 Tela do Sensor,  
 Págs.....310-312

**FILED :** Luz de fundo e moldura de perímetro

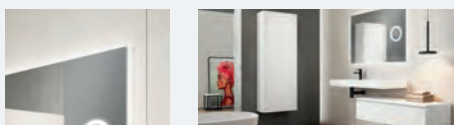

|     |              |         |                         |        |
|-----|--------------|---------|-------------------------|--------|
| LUZ | COR °K       | CONSUMO | POTÊNCIA                | ESTADO |
| LED | 5500K Branco | 9.6W    | 960 LUMENS metro linear | IP44   |

Personalize seus LEDs de 3000°K e 4200°K sem custo adicional. Standard de 5500°K.

| TIPOS             | A (cm)  | H (cm) | REF      | PVP |
|-------------------|---------|--------|----------|-----|
| <b>Padrão</b>     |         |        |          |     |
| 60                | 80      | 80     | SF.06080 | -   |
| 80                | 80      | 80     | SF.08080 | -   |
| 100               | 80      | 80     | SF.10080 | -   |
| 120               | 80      | 80     | SF.12080 | -   |
| 140               | 80      | 80     | SF.14080 | -   |
| <b>Sob medida</b> |         |        |          |     |
| 60 a 80           | 50 a 72 | 72     | SF.08072 | -   |
| 81 a 100          | 50 a 72 | 72     | SF.10072 | -   |
| 101 a 120         | 50 a 72 | 72     | SF.12072 | -   |
| 121 a 140         | 50 a 72 | 72     | SF.14072 | -   |
| 141 a 160         | 50 a 72 | 72     | SF.16072 | -   |
| 161 a 180         | 50 a 72 | 72     | SF.18072 | -   |
| 181 a 200         | 50 a 72 | 72     | SF.20072 | -   |
| 60 a 80           | 73 a 90 | 90     | SF.08090 | -   |
| 81 a 100          | 73 a 90 | 90     | SF.10090 | -   |
| 101 a 120         | 73 a 90 | 90     | SF.12090 | -   |
| 121 a 140         | 73 a 90 | 90     | SF.14090 | -   |
| 141 a 160         | 73 a 90 | 90     | SF.16090 | -   |
| 161 a 180         | 73 a 90 | 90     | SF.18090 | -   |
| 181 a 200         | 73 a 90 | 90     | SF.20090 | -   |

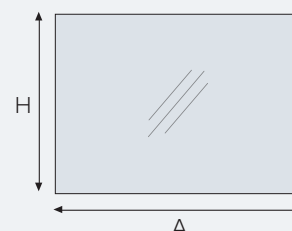

**& complementa**  
 Sistema antiembaçante,  
 Led 5X,  
 Sensor On/Off,  
 Sensor de Cor  
 Sensor Bluetooth,  
 Tela do Sensor,  
 Págs.....310-312

**SPINLED:** Luz de fundo do perímetro

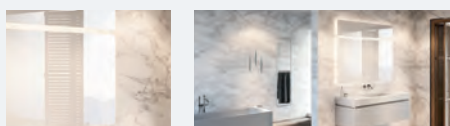

| LUZ | COR °K       | CONSUMO | POTÊNCIA                | ESTADO |
|-----|--------------|---------|-------------------------|--------|
| LED | 5500K Branco | 9.6W    | 960 LUMENS metro linear | IP44   |

Personalize seus LEDs de 3000°K e 4200°K sem custo adicional. Standard de 5500°K.

| TIPOS             | A (cm)    | H (cm)  | REF      | PVP |
|-------------------|-----------|---------|----------|-----|
| <b>Padrão</b>     |           |         |          |     |
|                   | 60        | 80      | SP.06080 | -   |
|                   | 80        | 80      | SP.08080 | -   |
|                   | 100       | 80      | SP.10080 | -   |
|                   | 120       | 80      | SP.12080 | -   |
|                   | 140       | 80      | SP.14080 | -   |
| <b>Sob medida</b> |           |         |          |     |
|                   | 60 a 80   | 50 a 72 | SP.08072 | -   |
|                   | 81 a 100  | 50 a 72 | SP.10072 | -   |
|                   | 101 a 120 | 50 a 72 | SP.12072 | -   |
|                   | 121 a 140 | 50 a 72 | SP.14072 | -   |
|                   | 141 a 160 | 50 a 72 | SP.16072 | -   |
|                   | 161 a 180 | 50 a 72 | SP.18072 | -   |
|                   | 181 a 200 | 50 a 72 | SP.20072 | -   |
|                   | 60 a 80   | 73 a 90 | SP.08090 | -   |
|                   | 81 a 100  | 73 a 90 | SP.10090 | -   |
|                   | 101 a 120 | 73 a 90 | SP.12090 | -   |
|                   | 121 a 140 | 73 a 90 | SP.14090 | -   |
|                   | 141 a 160 | 73 a 90 | SP.16090 | -   |
|                   | 161 a 180 | 73 a 90 | SP.18090 | -   |
|                   | 181 a 200 | 73 a 90 | SP.20090 | -   |

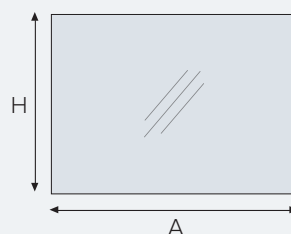

**& complementa**  
 Sistema antiembaçante, Led 5X, Sensor On/Off, Sensor de Cor, Sensor Bluetooth, Tela do Sensor, Págs.....310-312

**FRAMELED:** Retroiluminação do perímetro e LED frontal

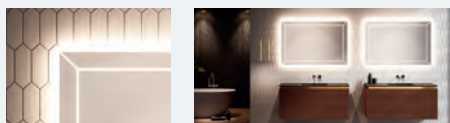

· O sensor acende e apaga a luz. Led perimetral e frontal

| LUZ | COR °K       | CONSUMO | POTÊNCIA                | ESTADO |
|-----|--------------|---------|-------------------------|--------|
| LED | 5500K Branco | 9.6W    | 960 LUMENS metro linear | IP44   |

| A (cm) | H (cm) | REF      | PVP |
|--------|--------|----------|-----|
| 60     | 80     | SM.06080 | -   |
| 80     | 80     | SM.08080 | -   |

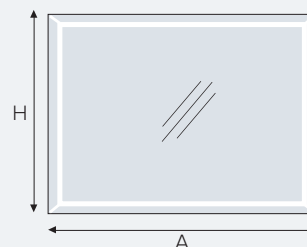

### FRONLED: Iluminação de perímetro frontal 4



- Padrão
- Perfil de perímetro de alumínio escovado

| LUZ | COR °K           | CONSUMO | POTÊNCIA                   | ESTADO |
|-----|------------------|---------|----------------------------|--------|
| LED | 5500°K<br>Branco | 9.6W    | 960 LUMENS<br>metro linear | IP44   |

Personalize seus LEDs de 3000°K e 4200°K sem custo adicional. Standard de 5500°K.

| A (cm) | H (cm) | REF      | PVP |
|--------|--------|----------|-----|
| 60     | 80     | SA.06080 | -   |
| 80     | 80     | SA.08080 | -   |
| 100    | 80     | SA.10080 | -   |
| 120    | 80     | SA.12080 | -   |

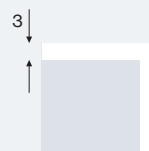
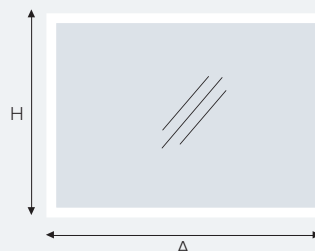

#### & complementa

Sistema antiembaçante,  
Led 5X,  
Sensor On/Off,  
Sensor de Cor  
Sensor Bluetooth,  
Tela do Sensor,  
Págs.....310-312

### DUOLED: Iluminação frontal

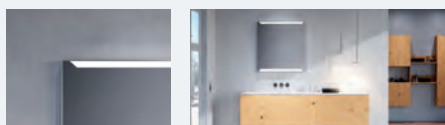
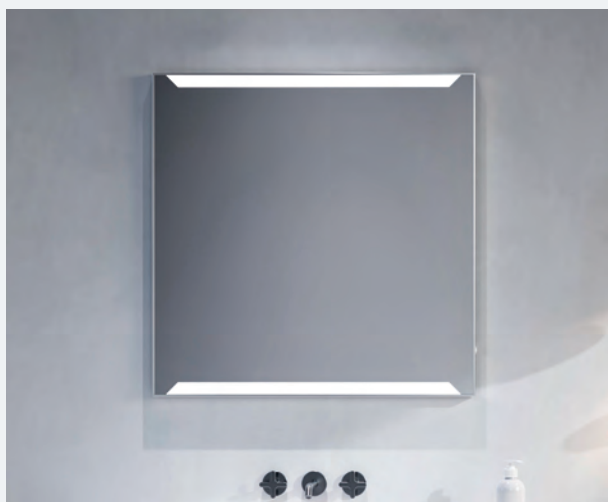

- Sensor On / Off lateral + Regulador de intensidade
- Perfil de perímetro de alumínio escovado

| LUZ | COR °K           | CONSUMO | POTÊNCIA                   | ESTADO |
|-----|------------------|---------|----------------------------|--------|
| LED | 5500°K<br>Branco | 9.6W    | 960 LUMENS<br>metro linear | IP44   |

Personalize seus LEDs de 3000°K e 4200°K sem custo adicional. Standard de 5500°K.

| A (cm) | H (cm) | REF      | PVP |
|--------|--------|----------|-----|
| 60     | 80     | SG.06080 | -   |
| 80     | 80     | SG.08080 | -   |
| 100    | 80     | SG.10080 | -   |
| 120    | 80     | SG.12080 | -   |

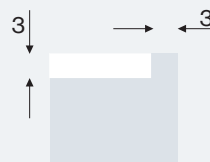
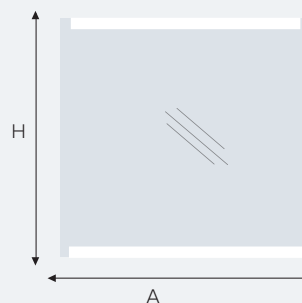

#### & complementa

Sistema Antiembaçante,  
Led 5X,  
Págs.....310



### TRILED: Iluminação frontal superior e lateral

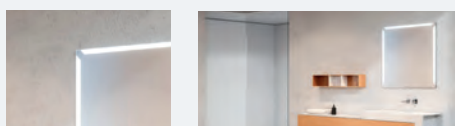

· Perfil de perímetro de alumínio escovado

| LUZ | COR °K       | CONSUMO | POTÊNCIA                | ESTADO |
|-----|--------------|---------|-------------------------|--------|
| LED | 5500K Branco | 9.6W    | 960 LUMENS metro linear | IP44   |

Personalize seus LEDs de 3000°K e 4200°K sem custo adicional. Standard de 5500°K.

| A (cm) | H (cm) | REF      | PVP |
|--------|--------|----------|-----|
| 60     | 80     | SH.06080 | -   |
| 80     | 80     | SH.08080 | -   |
| 100    | 80     | SH.10080 | -   |
| 120    | 80     | SH.12080 | -   |

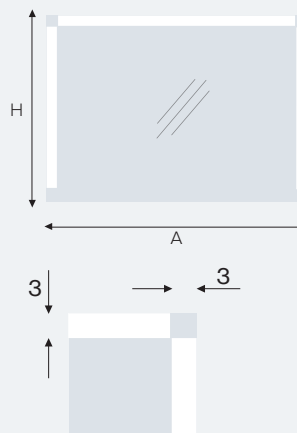

#### & complementa

Sistema Antiembaçante, Led 5X, Sensor On/Off, Sensor Colour, Sistema Bluetooth, Sistema Screen, Págs.....310-312

### EYELED: Iluminação frontal

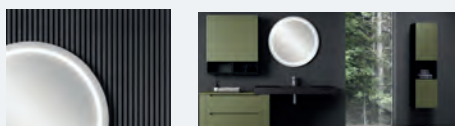

| LUZ | COR °K       | CONSUMO | POTÊNCIA                | ESTADO |
|-----|--------------|---------|-------------------------|--------|
| LED | 5500K Branco | 9.6W    | 960 LUMENS metro linear | IP44   |

Personalize seus LEDs de 3000°K e 4200°K sem custo adicional. Standard de 5500°K.

| D (cm) | REF      | PVP |
|--------|----------|-----|
| 60     | SY.06060 | -   |
| 80     | SY.08080 | -   |

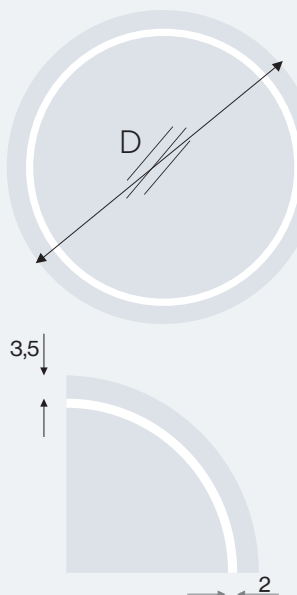

#### & complementa

Sistema Antiembaçante, Sensor On/Off, Sensor Antiembaçante Págs.....310-312

**METALROUNDED:** Led liso + redondo de metal



CORES:  
 Preto  
 Cromada

| LUZ | COR °K       | CONSUMO | POTÊNCIA                | ESTADO |
|-----|--------------|---------|-------------------------|--------|
| LED | 5500K Branco | 9.6W    | 960 LUMENS metro linear | IP44   |

Personalize seus LEDs de 3000°K e 4200°K sem custo adicional. Standard de 5500°K.

| TIPOS | D (cm) | REF | PVP |
|-------|--------|-----|-----|
|-------|--------|-----|-----|

|       |    |            |   |
|-------|----|------------|---|
| Preto | 60 | SJ.06060.N | - |
|       | 80 | SJ.08080.N | - |

|         |    |             |   |
|---------|----|-------------|---|
| Cromada | 60 | SJ.06060.CR | - |
|         | 80 | SJ.08080.CR | - |

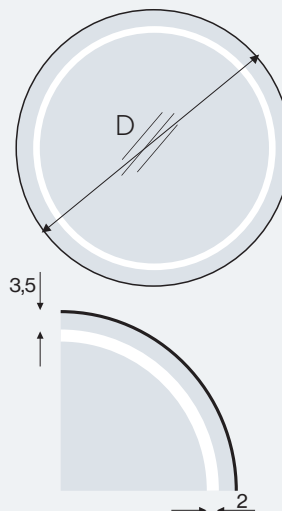

**& complementa**  
 Sistema Antiembaçante,  
 Sensor On/Off,  
 Sensor Antiembaçante  
 Págs.....310-312

**METALSQUARELED:** Metal liso + led quadrado



CORES:  
 Preto  
 Cromada

| LUZ | COR °K       | CONSUMO | POTÊNCIA                | ESTADO |
|-----|--------------|---------|-------------------------|--------|
| LED | 5500K Branco | 9.6W    | 960 LUMENS metro linear | IP44   |

Personalize seus LEDs de 3000°K e 4200°K sem custo adicional. Standard de 5500°K.

| TIPOS | A (cm) | H (cm) | REF | PVP |
|-------|--------|--------|-----|-----|
|-------|--------|--------|-----|-----|

|       |     |    |            |   |
|-------|-----|----|------------|---|
| Preto | 60  | 80 | SK.06080.N | - |
|       | 80  | 80 | SK.08080.N | - |
|       | 100 | 80 | SK.10080.N | - |
|       | 120 | 80 | SK.12080.N | - |

|         |     |    |             |   |
|---------|-----|----|-------------|---|
| Cromada | 60  | 80 | SK.06080.CR | - |
|         | 80  | 80 | SK.08080.CR | - |
|         | 100 | 80 | SK.10080.CR | - |
|         | 120 | 80 | SK.12080.CR | - |

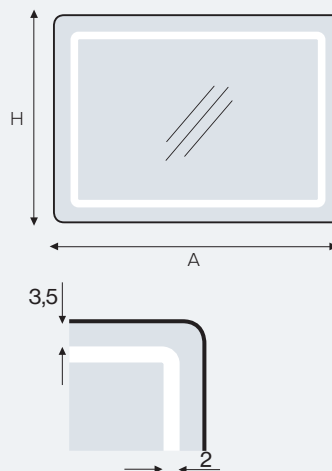

**& complementa**  
 Sistema Antiembaçante,  
 Sensor On/Off,  
 Sensor Antiembaçante  
 Págs.....310-312

**METALROUND:** Redondo em metal liso

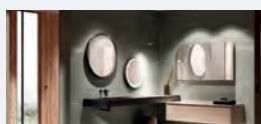

CORES:  
 Preto  
 Cromada

| TIPOS   | D (cm) | REF         | PVP |
|---------|--------|-------------|-----|
| Preto   | 60     | SL.06060.N  | -   |
|         | 80     | SL.08080.N  | -   |
| Cromada | 60     | SL.06060.CR | -   |
|         | 80     | SL.08080.CR | -   |

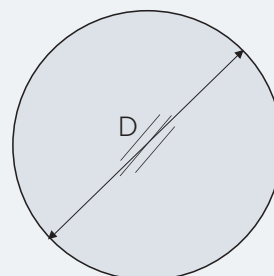

**& complementa**  
 Sistema Antiembaçante  
 Págs.....310

**METALSQUARE:** Quadrado em metal liso



CORES:  
 Preto  
 Cromada

| TIPOS   | A (cm) | H (cm) | REF         | PVP |
|---------|--------|--------|-------------|-----|
| Preto   | 60     | 80     | SQ.06080.N  | -   |
|         | 80     | 80     | SQ.08080.N  | -   |
|         | 100    | 80     | SQ.10080.N  | -   |
|         | 120    | 80     | SQ.12080.N  | -   |
| Cromada | 60     | 80     | SQ.06080.CR | -   |
|         | 80     | 80     | SQ.08080.CR | -   |
|         | 100    | 80     | SQ.10080.CR | -   |
|         | 120    | 80     | SQ.12080.CR | -   |

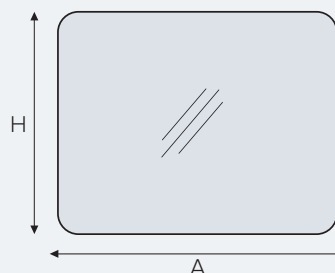

**& complementa**  
 Sistema Antiembaçante,  
 Led 5X  
 Págs.....310

**CORNER:** Moldura de madeira com perfil prismático

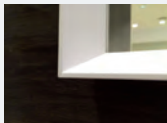

CORES

- Branco mate
- Preto mate

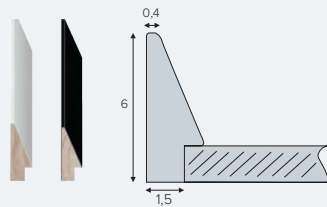

| A (cm)    | H (cm)    | REF       | PVP |
|-----------|-----------|-----------|-----|
| 60 a 80   | 60 a 90   | SU.08090  | -   |
| 81 a 100  | 60 a 90   | SU.10090  | -   |
| 101 a 120 | 60 a 90   | SU.12090  | -   |
| 121 a 140 | 60 a 90   | SU.14090  | -   |
| 141 a 160 | 60 a 90   | SU.16090  | -   |
| 161 a 180 | 60 a 90   | SU.18090  | -   |
| 181 a 200 | 60 a 90   | SU.20090  | -   |
|           |           |           |     |
| 40 a 60   | 150 a 200 | SU.060200 | -   |

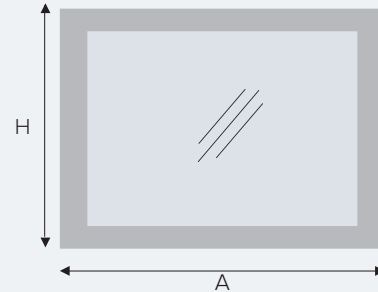

**LUXOR:** Madeira decorativa emoldurada



CORES

- Folha de prata
- Folha de ouro

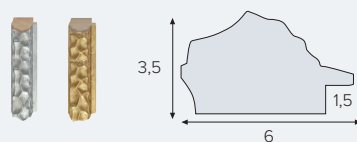

| A (cm)    | H (cm)    | REF       | PVP |
|-----------|-----------|-----------|-----|
| 60 a 80   | 60 a 90   | SX.08090  | -   |
| 81 a 100  | 60 a 90   | SX.10090  | -   |
| 101 a 120 | 60 a 90   | SX.12090  | -   |
| 121 a 140 | 60 a 90   | SX.14090  | -   |
| 141 a 160 | 60 a 90   | SX.16090  | -   |
| 161 a 180 | 60 a 90   | SX.18090  | -   |
| 181 a 200 | 60 a 90   | SX.20090  | -   |
|           |           |           |     |
| 40 a 60   | 150 a 200 | SX.060200 | -   |

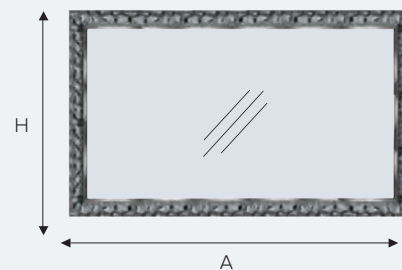

### 1 ARMÁRIO DE ESPELHO DE PORTA

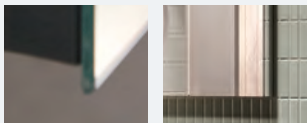
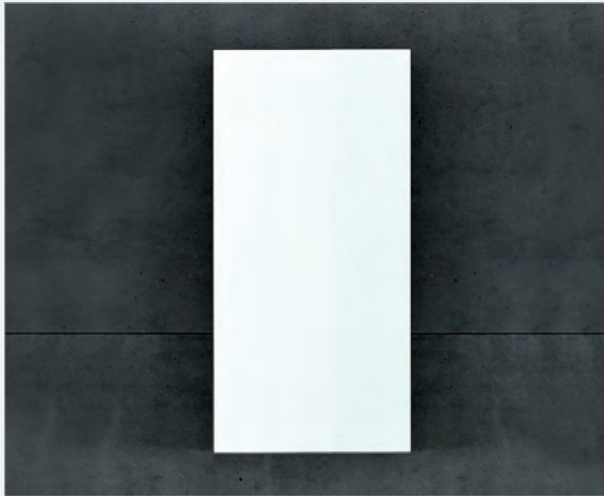

- Padrão e personalizado
- Cabides ajustáveis
- Modular
- Lados do espelho
- 2 prateleiras de vidro internas
- Interior antracite
- Compatível com inserções de espelho
- Porta com maçaneta inferior oculta e fechamento lento

| A (cm) | H (cm) | Apertura | REF      | PVP |
|--------|--------|----------|----------|-----|
| 30     | 72     |          | SW.3072I | -   |
| 30     | 72     |          | SW.3072D | -   |
| 40     | 72     |          | SW.4072I | -   |
| 40     | 72     |          | SW.4072D | -   |
| 60     | 72     |          | SW.6072I | -   |
| 60     | 72     |          | SW.6072D | -   |

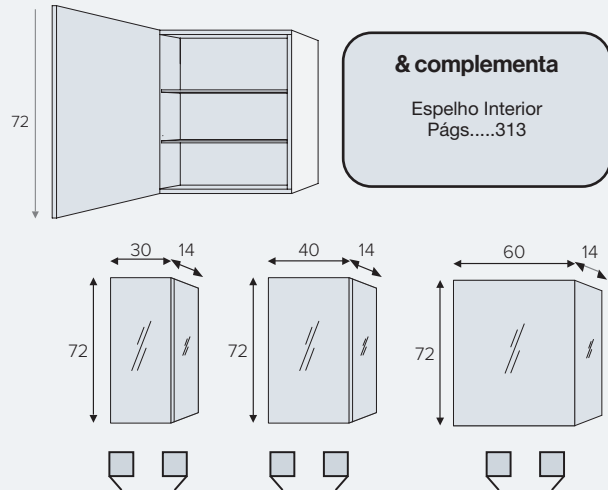

### ARMÁRIO DE ESPELHOS DE 2 PORTAS

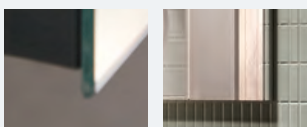
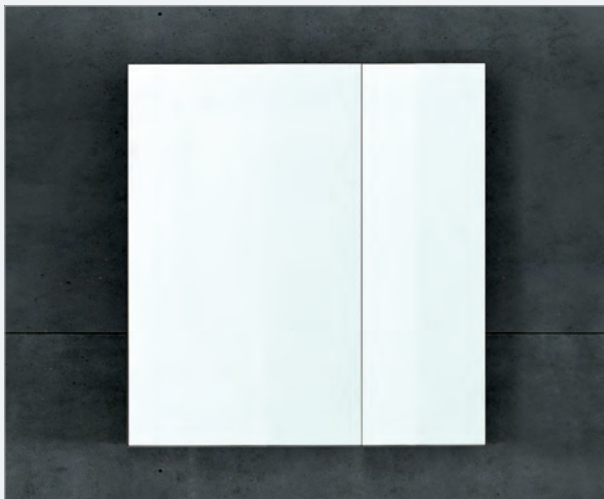

- Padrão e personalizado
- Cabides ajustáveis
- Modular
- Lados do espelho
- 2 prateleiras de vidro internas
- Interior antracite
- Compatível com inserções de espelho
- Porta com maçaneta inferior oculta e fechamento lento

| A (cm)      | H (cm) | Apertura | REF       | PVP |
|-------------|--------|----------|-----------|-----|
| 80 (60+20)  | 72     |          | SZ.8072I  | -   |
| 80 (20+60)  | 72     |          | SZ.8072D  | -   |
| 90 (60+30)  | 72     |          | SZ.9072I  | -   |
| 90 (30+60)  | 72     |          | SZ.9072D  | -   |
| 100 (60+40) | 72     |          | SZ.10072I | -   |
| 100 (40+60) | 72     |          | SZ.10072D | -   |

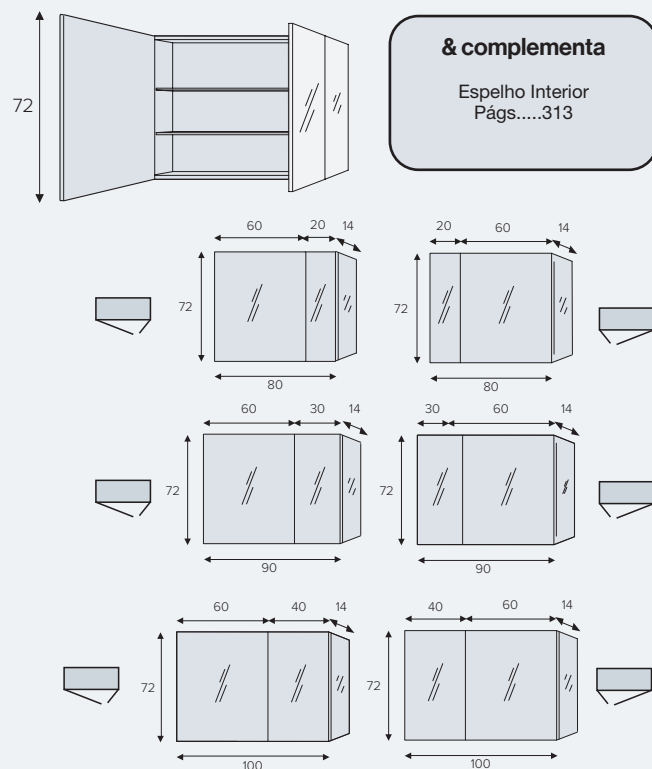

### SISTEMA ANTIEMBAÇANTE

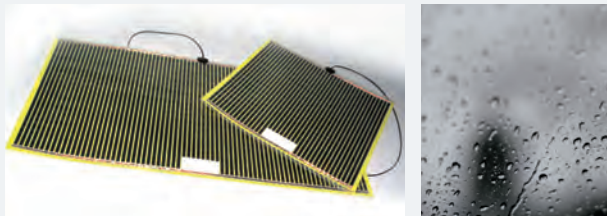

CONSUMO

9.6W

ESTADO

IP44

### SENSOR ANTIEMBAÇANTE



Antiembaçante



### LED 5X



LED 5X



Ø 17cm

REF

PVP

X004UNO (Indicado para móveis de lavatório)

-

X004DOS (Indicado para móveis com duas pias)

-

#### Sistema Antiembaçante

Evite a condensação de água no espelho que distorce a imagem. Ele pode ser conectado diretamente à rede elétrica ou ligado e desligado com o sensor de toque.

Dependendo do equipamento e da estrutura do espelho, nosso departamento industrial escolherá o sistema antiembaçante mais adequado para o espelho.

REF

PVP

X008

-

Requer sistema antiembaçante

#### Sensor Antiembaçante

Permite ligar e desligar o sistema de desembaçamento.

REF

PVP

X015

-

#### LED 5X

Espelho de aumento 5X integrado no próprio espelho. Perímetro iluminado por luz LED.

**SENSOR ON / OFF**



On / Off  
+  
Regulador  
intensidade

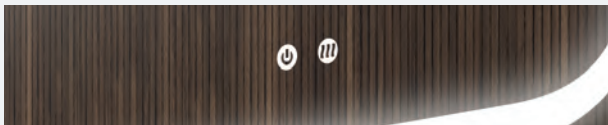

**SENSOR COLOUR**



On / Off — 3000°K  
5000°K  
Regulador  
intensidade



**TIPO**

**REF**

**PVP**

|   |      |   |
|---|------|---|
| ON / OFF sensor sem sensor antiembaçante                  | X007 | - |
| ON / OFF sensor com antiembaçante (requer X004DOS o X008) | X009 | - |

**SENSOR ON / OFF**

Liga ou desliga a luz LED e também permite ajustar sua intensidade de acordo com a escolha do usuário.

**& compatível** com sistema antiembaçante e LED 5X

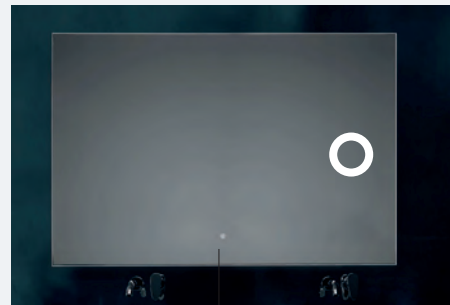

Anti nevoeiro  
(Opcional)

LED 5X  
(Opcional)

**REF**

**PVP**

|      |   |
|------|---|
| X011 | - |
|------|---|

**SENSOR COLOUR**

Permite alterar a temperatura da cor da luz quente, neutra ou fria e / ou a intensidade da luz.

**& compatível** com sistema antiembaçante e LED 5X

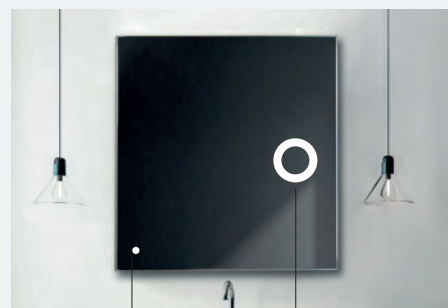

Antiembaçante  
(Opcional)

LED 5X  
(Opcional)

**SENSOR DE BLUETOOTH**

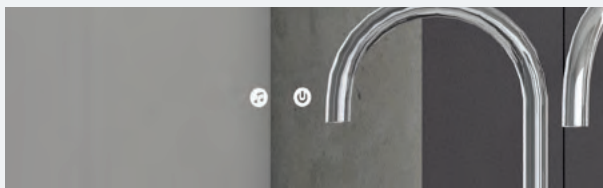
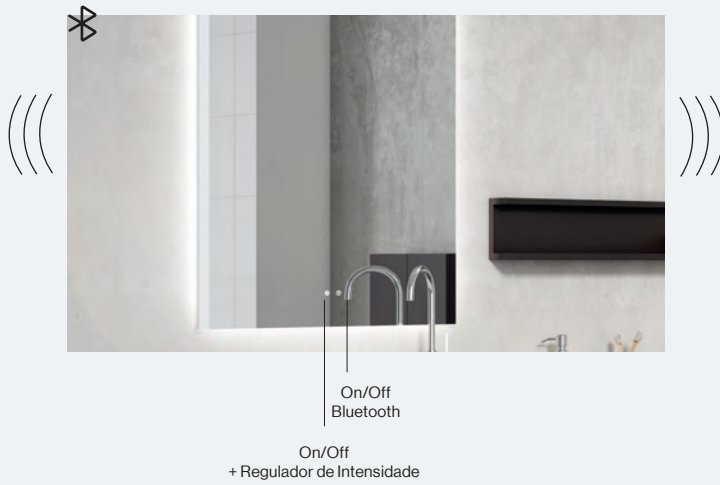

REF

PVP

X013

-

**SENSOR BLUETOOTH**

Permite que você conecte o espelho ao telefone celular através do dispositivo Bluetooth. Ele também inclui um sistema de alto-falantes embutido no espelho. Inclui sistema On / Off para ignição e ajuste de intensidade.

**& compatível** com sistema antiembaçante e LED 5X



Anti nevoeiro (Opcional)

LED 5X (Opcional)

**SENSOR SCREEN**

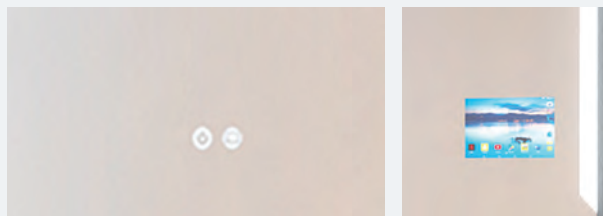

Tamanho Screen: 17 de largura x 10 de altura (cm)

REF

PVP

X012

-

Disponível a partir de espelhos de 80 cm de largura.

**SISTEMA SCREEN**

Ele permite que você conecte o espelho ao telefone celular através do dispositivo Bluetooth e replique a tela do telefone celular. Tela de 10 polegadas. Inclui sistema com ignição On / Off e ajuste de intensidade.

**& compatível** com Sistema Antiembaçante

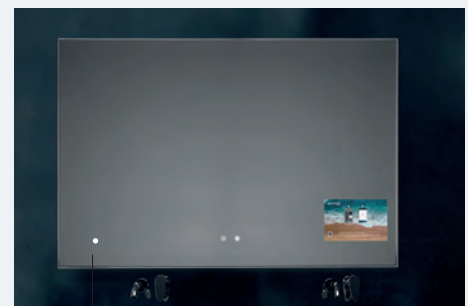

Anti nevoeiro (Opcional)



### 3X ESPELHO DE AMPLIAÇÃO MAGNÉTICA

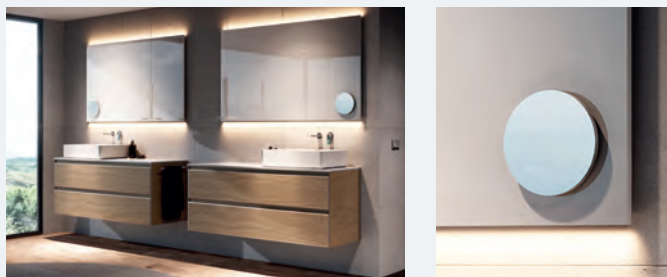

| D (cm) | REF       | PVP |
|--------|-----------|-----|
| 14     | 98912 MAG | -   |

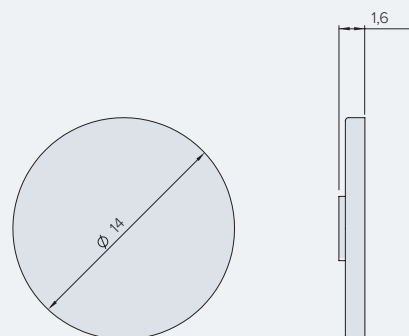

### GABINETE-ESPELHO INTERNO



Adequado para armários de espelho e armários de parede.

| PORTA    | A (cm) | H (cm) | REF      | PVP |
|----------|--------|--------|----------|-----|
| 30/40/60 | 22     | 68     | 98922INT | -   |
| 20*      | 12     | 68     | 98923INT | -   |

\*Para a porta de 20 cm, o espelho interno tem 12 cm de largura.

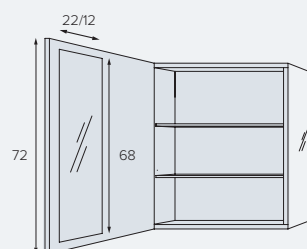



# 05 Iluminação

A tecnologia LED aplicada aos apliques de espelho e na iluminação decorativa permite que o criar cenários personalizados.



**LUZES DE ESPELHO**

Apliques para serem instalados por cima dos espelhos e nos espelhos do roupeiro. Diferentes modelos, potências e temperaturas de cor.



**Ledin**  
pág. 318

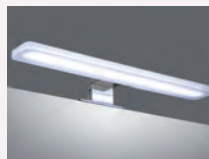

**Ledcrl**  
pág. 318

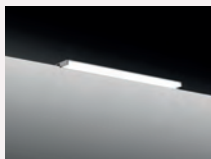

**Ledbar**  
pág. 319

**ILUMINAÇÃO DECORATIVA**

Iluminação suspensa decorativa e luz personalizável para criar ambientes.



**Ledarc**  
pág. 320



**Ledpoint**  
pág. 320

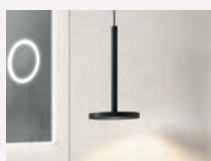

**Ledcirc**  
pág. 321

## O que você precisa saber para ter um boa iluminação em sua casa de banho?

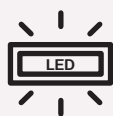

### TIPO DE LUZ

O tipo de luz led é de baixíssimo consumo, ignição rápida e longa vida; também não emite calor. Para o seu funcionamento necessita de um driver que em muitos casos está integrado no próprio projetor.



### CONSUMO

É medido em watts (w). Menos watts, menor consumo. O "w" não é a referência para medir a intensidade da luz e sua capacidade luminosa; mas para fazer isso, vamos olhar para lumens / lux.

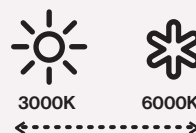

### TEMPERATURA DE COR

É a tonalidade da luz, expressa em graus Kelvin (°K). Um matiz quente mais amarelado é cerca de 3000K e um matiz mais frio mais branco é cerca de 5000-6000K. A tendência é ir para tons neutros que estão em 4000°K.



### LUMENS

A variável para identificar se uma luminária fornece mais luz do que outra são os lumens. Quanto mais lumens, maior é a intensidade da luz. De acordo com os códigos gerais de iluminação em uma casa de banho, existem duas necessidades de luz.

- A área do armário do lavatório. Para maquiagem ou barbear, um mínimo de 300 lumens é recomendado. Aproximadamente 700 lumens são ideais para ajudar na iluminação geral da casa de banho. Se a iluminação também for neutra (4000°K), ajuda a prevenir a descoloração da pele.
- A área de trânsito. Os refletores de teto devem nos fornecer uma luz ambiente suave. Aproximadamente 200 300 lumens por m<sup>2</sup> são recomendados.



### ESTADO

É o nível de exposição aos elementos ou agentes externos como a água. É medido por IP e variam de IP20, IP44 e IP65, de menos a mais estanque.

**LEDIN**



Compatível com espelhos lisos e espelhos de guarda-roupa

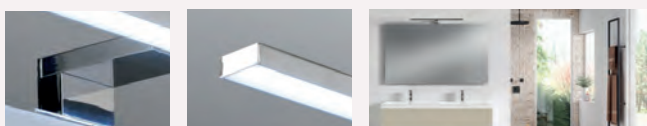

LUZ

LED

COR\*<sup>o</sup>K

4000°K  
Neutro

CONSUMO

4.71 W  
8 W

ESTADO

IP20

| A (cm) | Cor            | Temp (°K) | Consumo (W) | Lumens (lm) | REF      | PVP |
|--------|----------------|-----------|-------------|-------------|----------|-----|
| 30     | Cromada brilho | 4000      | 4.71        | 325         | LAI.30.B | -   |
| 45     | Cromada brilho | 4000      | 8           | 465         | LAI.45.B | -   |

|    |       |      |      |     |          |   |
|----|-------|------|------|-----|----------|---|
| 30 | Preto | 4000 | 4.71 | 325 | LAI.30.N | - |
| 45 | Preto | 4000 | 8    | 465 | LAI.45.N | - |

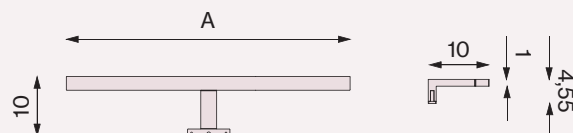

**LEDCRIL**

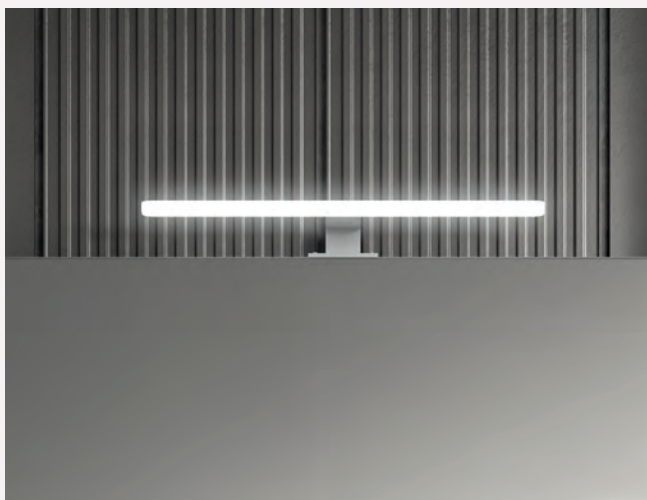

Compatível com espelhos lisos e espelhos de guarda-roupa



LUZ

LED

COR\*<sup>o</sup>K

4000°K  
Neutro

CONSUMO

8 W  
12 W

ESTADO

IP20

| A (cm) | Cor                          | Temp (°K) | Consumo (W) | Lumens (lm) | REF      | PVP |
|--------|------------------------------|-----------|-------------|-------------|----------|-----|
| 45     | Cromada brilho e metacrilato | 4000      | 8           | 890         | LAC.45.B | -   |
| 60     | Cromada brilho e metacrilato | 4000      | 12          | 1295        | LAC.60.B | -   |

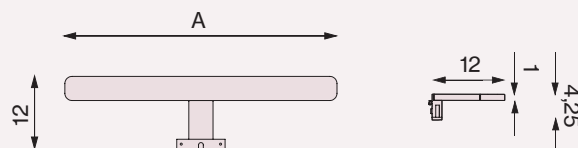

### LEDBAR

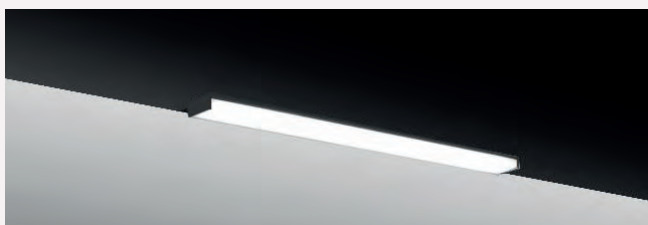

Compatível com o modelo SLM

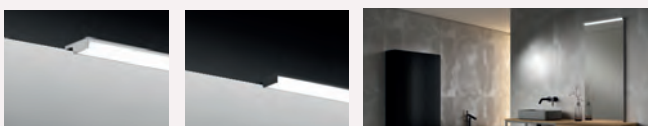

LUZ

LED

COR\*°K

4000°K  
Neutro

CONSUMO

4.9W  
8W

ESTADO

IP20

| A (cm) | Cor   | Temp (°K) | Consumo (W) | Lumens (lm) | REF      | PVP |
|--------|-------|-----------|-------------|-------------|----------|-----|
| 60     | Cromo | 4000      | 15          | 1365        | LAB.60.B | -   |
| 80     | Cromo | 4000      | 20          | 1870        | LAB.80.B | -   |
| 100    | Cromo | 4000      | 25          | 2355        | LAB.10.B | -   |
| 120    | Cromo | 4000      | 30          | 2780        | LAB.12.B | -   |
| 140    | Cromo | 4000      | 35          | 3320        | LAB.14.B | -   |

|     |       |      |    |      |          |   |
|-----|-------|------|----|------|----------|---|
| 60  | Preto | 4000 | 15 | 1365 | LAB.60.N | - |
| 80  | Preto | 4000 | 20 | 1870 | LAB.80.N | - |
| 100 | Preto | 4000 | 25 | 2355 | LAB.10.N | - |
| 120 | Preto | 4000 | 30 | 2780 | LAB.12.N | - |
| 140 | Preto | 4000 | 35 | 3320 | LAB.14.N | - |

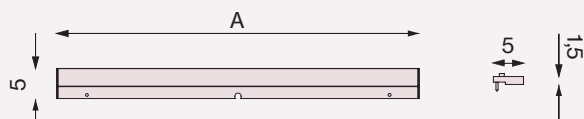

LEDARC



Ganchos de suspensão ajustáveis

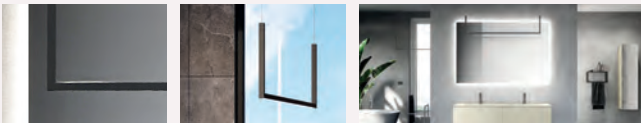

| LUZ | COR*°K           | CONSUMO | ESTADO |
|-----|------------------|---------|--------|
| LED | 3000°K<br>Quente | 26W     | IP20   |

| A (cm) | Cor   | Temp (°K) | Consumo (W) | Lumens (lm) | REF      | PVP |
|--------|-------|-----------|-------------|-------------|----------|-----|
| 120    | Preto | 3000      | 26          | 3500        | LCA.12.N | -   |

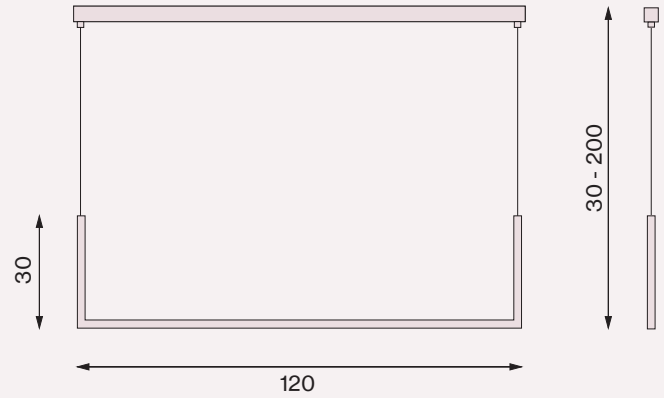

LEDPOINT



Ganchos de suspensão ajustáveis

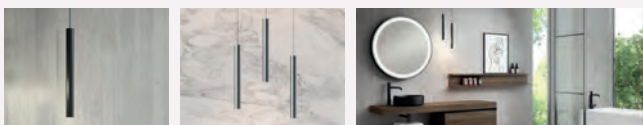

| LUZ | COR*°K                               | CONSUMO | ESTADO |
|-----|--------------------------------------|---------|--------|
| LED | 3000°K<br>Quente<br>4000°K<br>Neutro | 6W      | IP20   |

| Cor    | Temp (°K) | Consumo (W) | Lumens (lm) | REF       | PVP |
|--------|-----------|-------------|-------------|-----------|-----|
| Branco | 3000      | 6           | 760         | LCP.30.W  | -   |
| Branco | 4000      | 6           | 760         | LCP.40.W  | -   |
| Preto  | 3000      | 6           | 760         | LCP.30.N  | -   |
| Preto  | 4000      | 6           | 760         | LCP.40.N  | -   |
| Cobre  | 3000      | 6           | 760         | LCP.30.CU | -   |
| Cobre  | 4000      | 6           | 760         | LCP.40.CU | -   |
| Ouro   | 3000      | 6           | 760         | LCP.30.AU | -   |
| Ouro   | 4000      | 6           | 760         | LCP.40.AU | -   |
| Aço    | 3000      | 6           | 760         | LCP.30.S  | -   |
| Aço    | 4000      | 6           | 760         | LCP.40.S  | -   |

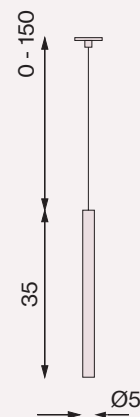



LEDCIRC



Ganchos de suspensão ajustáveis

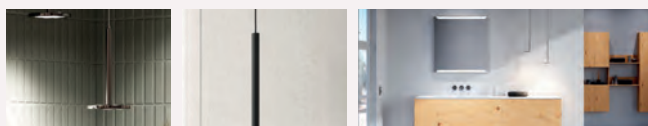

LUZ

LED

COR °K

3000°K  
Quente

CONSUMO

6W

ESTADO

IP20

| Cor    | Temp (°K) | Consumo (W) | Lumens (lm) | REF       | PVP |
|--------|-----------|-------------|-------------|-----------|-----|
| Branco | 3000      | 6           | 660         | LCC.30.W  | -   |
| Preto  | 3000      | 6           | 660         | LCC.30.N  | -   |
| Cobre  | 3000      | 6           | 660         | LCC.30.CU | -   |
| Ouro   | 3000      | 6           | 660         | LCC.30.AU | -   |
| Aço    | 3000      | 6           | 660         | LCC.30.S  | -   |

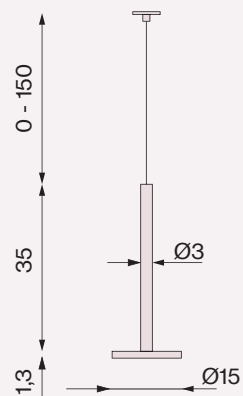





# 06

## Auxiliares

A decoração da casa de banho é um conjunto.  
Colunas, armários, prateleiras, banheiras ou  
acessórios somam uma proposta abrangente.

## COLUNAS



**Coluna suspensa  
H160 porta madeira**

pág. 328



**Coluna suspensa  
H160 Vitrina**

pág. 328



**Coluna suspensa  
H160 Espelho**

pág. 329



**Coluna suspensa  
H160 Decorativo**

pág. 329

## ARMÁRIOS

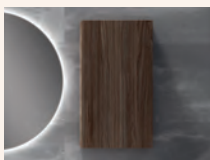

**Armário madeira H72**

pág. 330

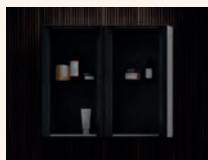

**Armário H72 mostras**

pág. 330



**Armário H72 da porta  
do espelho**

pág. 331



**Armário decorativo H90**

pág. 331

## PRATELEIRAS



**Prateleira Complet**

pág. 332

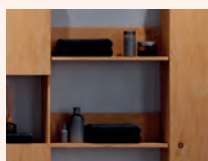

**Prateleira Twin**

pág. 332



**Prateleira Box**

pág. 333

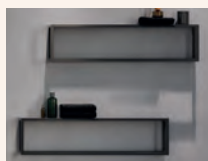

**Prateleira metálica  
dupla**

pág. 333

TOALHEIROS



**Prateleiras de metal com toalheiro**

pág. 334



**Toalheiro de parede**

pág. 334



**Rack para toalhas de pé independente**

pág. 335



**Calçada**

pág. 335

AUXILIARES ATELIER

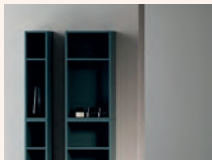

**Módulo de coluna**

pág. 336

By **CÍRCULO CUADRADO**



**Set de penteadeiras**

pág. 337

By **CÍRCULO CUADRADO**

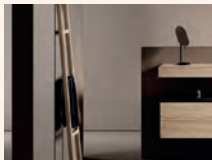

**Toalheiro Lean**

pág. 337



### PUSH PORTAS SEM PUXADOR

As portas das colunas e armários possuem sistema de push ejeção que também pode ser utilizado apenas como retentor.

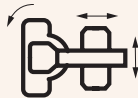

### BLUM 3D HINGES

As dobradiças são ajustáveis em altura, profundidade e inclinação para um encaixe perfeito.

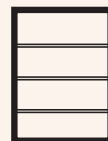

### PRATELEIRAS PARA INTERIORES CRISTAL

As prateleiras de vidro interiores têm 6 mm de espessura. No caso de vitrines e armários, as prateleiras são cinza fumê.



### SISTEMA DE SEGURANÇA DE SUSPENSÃO ANTI-SUSPENSÃO 150 KG

As colunas e armários possuem sistema de suspensão de segurança com capacidade de carga de 150 Kg.



### FULLCOLOR ANTHRACITE

Conceito de design interior pelo qual todos os materiais interiores do mobiliário são desenhados em antracite. Os móveis com acabamento lacado são lacados internamente a antracite.



### À MEDIDA

Esta coleção permite a fabricação sob encomenda. No caso de medidas intermediárias altura e largura cobram o preço da medida imediatamente superior.



### DECOBUILD SYSTEM

Móveis feitos de placas de 19 mm colados com cutelos alcançando uma estética limpar sem hardware visível e oferecer melhor resistência e durabilidade.



### WOOD PROTECT SYSTEM

Madeiras de tábua madeira maciça ou marinha São protegidos contra agentes externos com óleos naturais que respeitam a textura e a natureza da madeira.



### DURALACK SYSTEM

As cores envernizadas contêm aditivos endurecedores que permitem que o acabamento final seja altamente resistente ao atrito e à abrasão.

## Escolha a cor do seu mobiliário auxiliar

### Lacado



### Prancha Madeira Marinha / Folheado de Carvalho e Nogueira

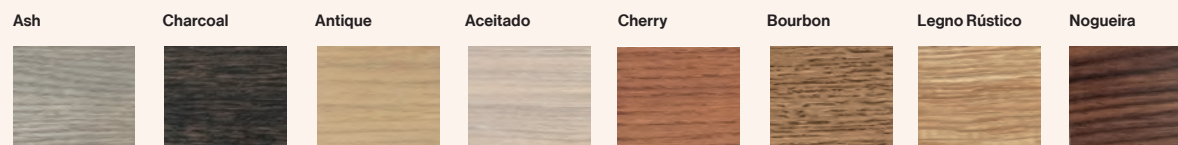

### Madeira Nature

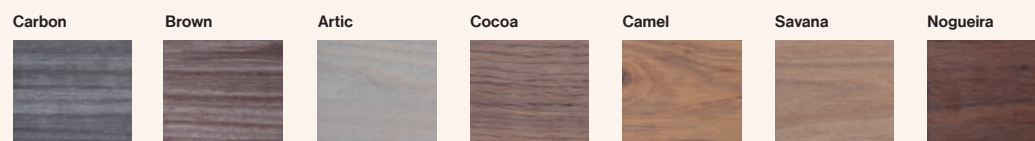

### Madeira Sólida / Roble

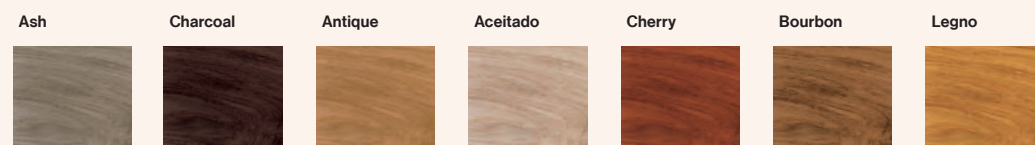

## COLUNA SUSPENSA H160 MADEIRA



- Interior: 4 prateleiras vidro / 5 orifícios
- Sistema de abertura por Push
- Costas antracite

| A (cm) | H (cm) | Abertura | REF      | MADEIRA NATURE | LACA | PRANCHA MADEIRA MARINHA |
|--------|--------|----------|----------|----------------|------|-------------------------|
|        |        |          |          | PVP            | PVP  | PVP                     |
| 30     | 160    |          | XCM.030I | -              | -    | -                       |
| 30     | 160    |          | XCM.030D | -              | -    | -                       |
| 40     | 160    |          | XCM.040I | -              | -    | -                       |
| 40     | 160    |          | XCM.040D | -              | -    | -                       |
| 60     | 160    |          | XCM.060X | -              | -    | -                       |

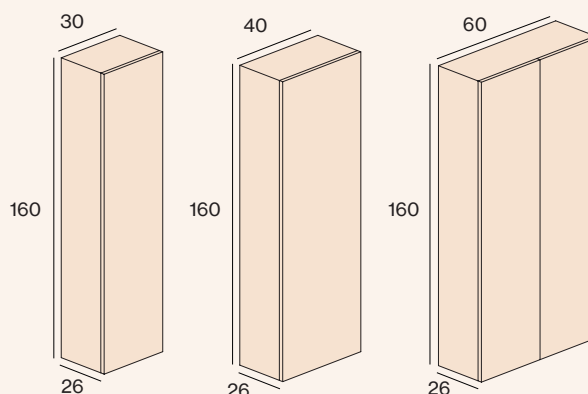

## COLUNA SUSPENSA H160 VITRINA

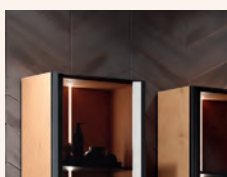

- Interior: 4 prateleiras vidro / 5 orifícios
- Sistema de abertura por push
- Costas antracite
- Porta com moldura preta fosco com vidro preto fumê

| A (cm) | H (cm) | Abertura | REF      | MADEIRA NATURE | LACA | PRANCHA MADEIRA MARINHA |
|--------|--------|----------|----------|----------------|------|-------------------------|
|        |        |          |          | PVP            | PVP  | PVP                     |
| 30     | 160    |          | XCV.030I | -              | -    | -                       |
| 30     | 160    |          | XCV.030D | -              | -    | -                       |
| 40     | 160    |          | XCV.040I | -              | -    | -                       |
| 40     | 160    |          | XCV.040D | -              | -    | -                       |
| 60     | 160    |          | XCV.060X | -              | -    | -                       |

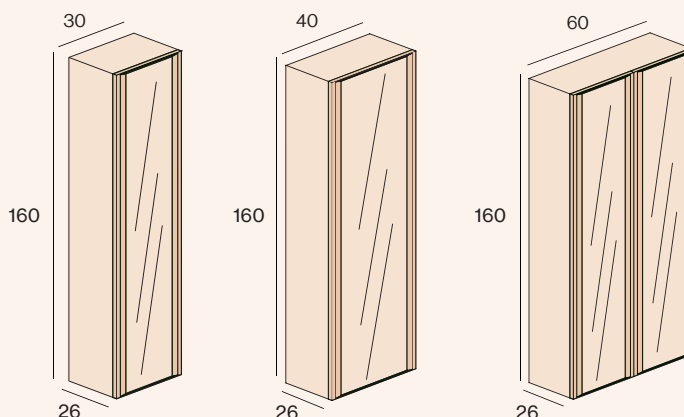

Você pode equipar sua coluna com iluminação interior. Veja a pág. 250



### COLUNA SUSPensa H160 ESPELHO

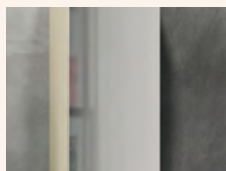

- Interior: 4 prateleiras vidro / 5 orificios
- Sistema de abertura por Push
- Costas antracite

| A (cm) | H (cm) | Abertura | REF      | MADEIRA NATURE | LACA | PRANCHA MADEIRA MARINHA |
|--------|--------|----------|----------|----------------|------|-------------------------|
|        |        |          |          | PVP            | PVP  | PVP                     |
| 30     | 160    |          | XCE.030I | -              | -    | -                       |
| 30     | 160    |          | XCE.030D | -              | -    | -                       |
| 40     | 160    |          | XCE.040I | -              | -    | -                       |
| 40     | 160    |          | XCE.040D | -              | -    | -                       |
| 60     | 160    |          | XCE.060X | -              | -    | -                       |

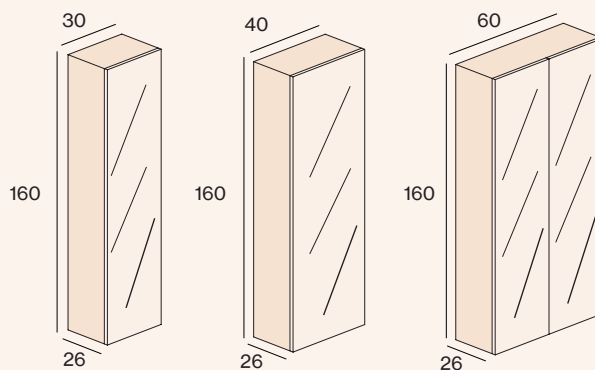

### COLUNA SUSPensa H160 DECORATIVA

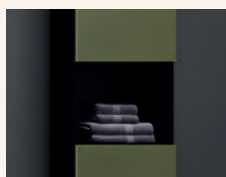

- Interior: porta superior
- 2 prateleiras de vidro / 3 ocios
- Sistema de abertura por Push
- Costas antracite

| A (cm) | H (cm) | Abertura | REF      | MADEIRA NATURE | LACA | PRANCHA MADEIRA MARINHA |
|--------|--------|----------|----------|----------------|------|-------------------------|
|        |        |          |          | PVP            | PVP  | PVP                     |
| 30     | 160    |          | XCD.030I | -              | -    | -                       |
| 30     | 160    |          | XCD.030D | -              | -    | -                       |
| 40     | 160    |          | XCD.040I | -              | -    | -                       |
| 40     | 160    |          | XCD.040D | -              | -    | -                       |
| 60     | 160    |          | XCD.060X | -              | -    | -                       |

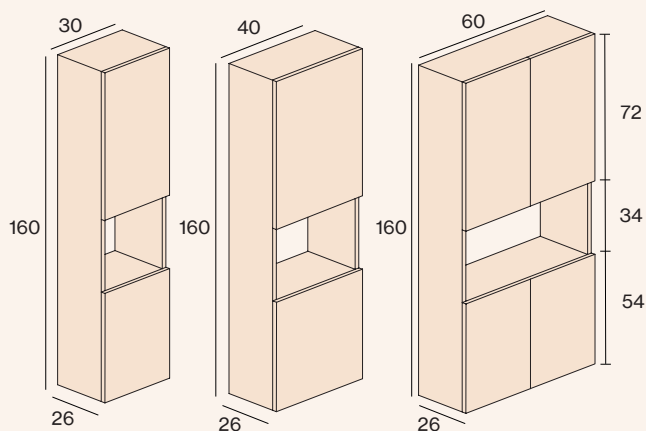

#### PATAS H7

- Conjunto de pernas cromadas brilhantes, altura 7 cm. (4 unidades)

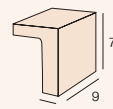

Cromo Brilho



| REF | UDS | PVP |
|-----|-----|-----|
| CM7 | 4   | -   |

#### PATAS H3

- Conjunto de pernas cromadas brilhantes, altura 3 cm. (4 unidades)

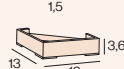

Cromo Brilho



| REF | UDS | PVP |
|-----|-----|-----|
| CM6 | 4   | -   |

### ARMÁRIO MADEIRA H72

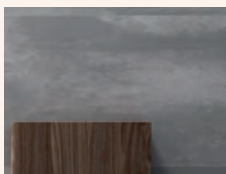

- Interior: 2 prateleiras vidro / 3 orifícios
- Sistema de abertura por push
- Costas antracite

| A (cm) | H (cm) | Abertura | REF      | MADEIRA NATURE | LACA | PRANCHA MADEIRA MARINHA |
|--------|--------|----------|----------|----------------|------|-------------------------|
|        |        |          |          | PVP            | PVP  | PVP                     |
| 30     | 72     | ☐        | XAM.030I | -              | -    | -                       |
| 30     | 72     | ☐        | XAM.030D | -              | -    | -                       |
| 40     | 72     | ☐        | XAM.040I | -              | -    | -                       |
| 40     | 72     | ☐        | XAM.040D | -              | -    | -                       |
| 60     | 72     | ☐        | XAM.060X | -              | -    | -                       |

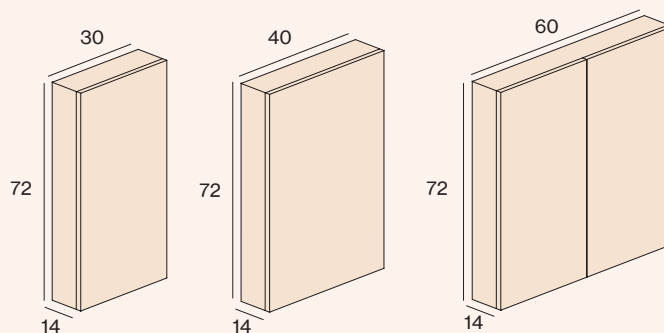

### ARMÁRIO H72 MOSTRAS

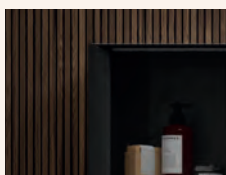
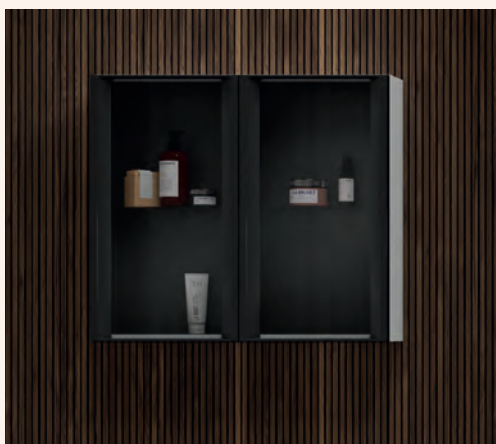

- Interior: 2 prateleiras vidro / 3 orifícios
- Sistema de abertura por push
- Costas antracite
- Porta com moldura preta fosco com vidro preto fumê

| A (cm) | H (cm) | Abertura | REF      | MADEIRA NATURE | LACA | PRANCHA MADEIRA MARINHA |
|--------|--------|----------|----------|----------------|------|-------------------------|
|        |        |          |          | PVP            | PVP  | PVP                     |
| 30     | 72     | ☐        | XAV.030I | -              | -    | -                       |
| 30     | 72     | ☐        | XAV.030D | -              | -    | -                       |
| 40     | 72     | ☐        | XAV.040I | -              | -    | -                       |
| 40     | 72     | ☐        | XAV.040D | -              | -    | -                       |
| 60     | 72     | ☐        | XAV.060X | -              | -    | -                       |

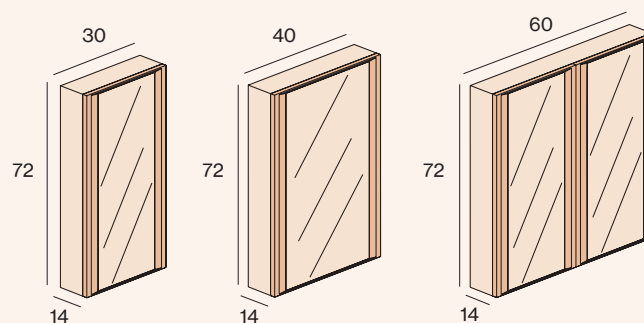

### ARMÁRIO H72 DA PORTA DO ESPELHO

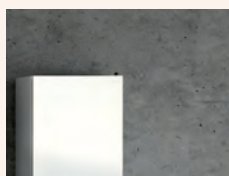
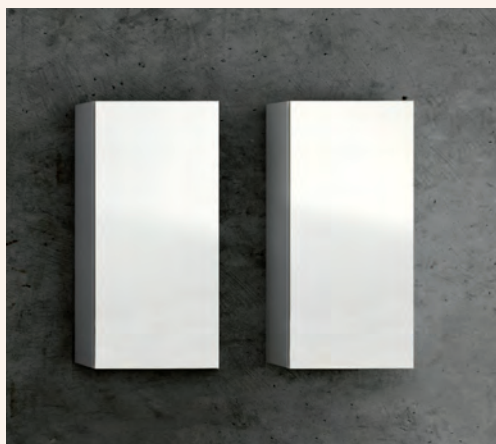

- Interior: 2 prateleiras vidro / 3 orifícios
- Sistema de abertura por push
- Costas antracite

| A (cm) | H (cm) | Abertura | REF      | MADEIRA NATURE | LACA | PRANCHA MADEIRA MARINHA |
|--------|--------|----------|----------|----------------|------|-------------------------|
|        |        |          |          | PVP            | PVP  | PVP                     |
| 30     | 72     |          | XAE.030I | -              | -    | -                       |
| 30     | 72     |          | XAE.030D | -              | -    | -                       |
| 40     | 72     |          | XAE.040I | -              | -    | -                       |
| 40     | 72     |          | XAE.040D | -              | -    | -                       |
| 60     | 72     |          | XAE.060X | -              | -    | -                       |

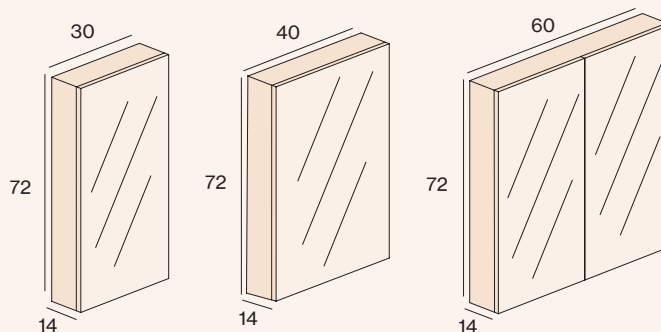

### ARMÁRIO DECORATIVO H90



- Interior: 2 prateleiras vidro / 3 orifícios
- Sistema de abertura por push
- Costas antracite

| A (cm) | H (cm) | Abertura | REF      | MADEIRA NATURE | LACA | PRANCHA MADEIRA MARINHA |
|--------|--------|----------|----------|----------------|------|-------------------------|
|        |        |          |          | PVP            | PVP  | PVP                     |
| 30     | 90     |          | XAD.030I | -              | -    | -                       |
| 30     | 90     |          | XAD.030D | -              | -    | -                       |
| 40     | 90     |          | XAD.040I | -              | -    | -                       |
| 40     | 90     |          | XAD.040D | -              | -    | -                       |
| 60     | 90     |          | XAD.060X | -              | -    | -                       |

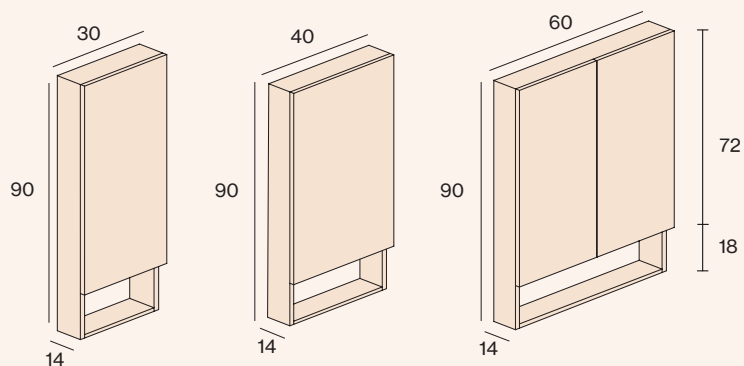

PRATELEIRA COMPLET

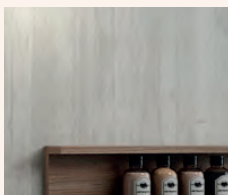

| A (cm) | REF     | MADEIRA NATURE | LACA | PRANCHA MADEIRA MARINHA | MADEIRA SÓLIDO |
|--------|---------|----------------|------|-------------------------|----------------|
|        |         | PVP            | PVP  | PVP                     | PVP            |
| 30     | XEC.030 | -              | -    | -                       | -              |
| 40     | XEC.040 | -              | -    | -                       | -              |
| 60     | XEC.060 | -              | -    | -                       | -              |
| 70     | XEC.070 | -              | -    | -                       | -              |
| 80     | XEC.080 | -              | -    | -                       | -              |
| 90     | XEC.090 | -              | -    | -                       | -              |
| 100    | XEC.100 | -              | -    | -                       | -              |
| 120    | XEC.120 | -              | -    | -                       | -              |
| 140    | XEC.140 | -              | -    | -                       | -              |

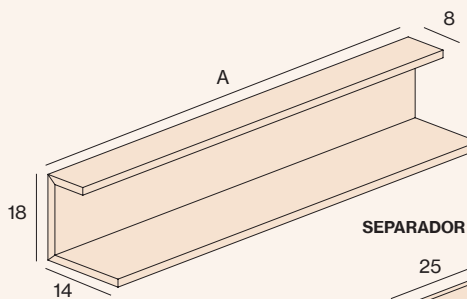

SEPARADOR DE ACESSÓRIO

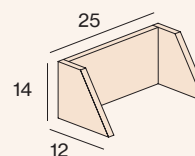

| REF      | PVP |
|----------|-----|
| XSD.2501 | -   |

Lacado

PRATELEIRA TWIN

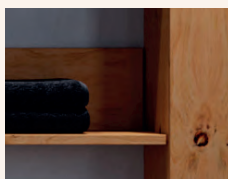

| A (cm) | REF     | MADEIRA NATURE | LACA | PRANCHA MADEIRA MARINHA | MADEIRA SÓLIDO |
|--------|---------|----------------|------|-------------------------|----------------|
|        |         | PVP            | PVP  | PVP                     | PVP            |
| 30     | XEL.030 | -              | -    | -                       | -              |
| 40     | XEL.040 | -              | -    | -                       | -              |
| 60     | XEL.060 | -              | -    | -                       | -              |
| 70     | XEL.070 | -              | -    | -                       | -              |
| 80     | XEL.080 | -              | -    | -                       | -              |
| 90     | XEL.090 | -              | -    | -                       | -              |
| 100    | XEL.100 | -              | -    | -                       | -              |
| 120    | XEL.120 | -              | -    | -                       | -              |
| 140    | XEL.140 | -              | -    | -                       | -              |

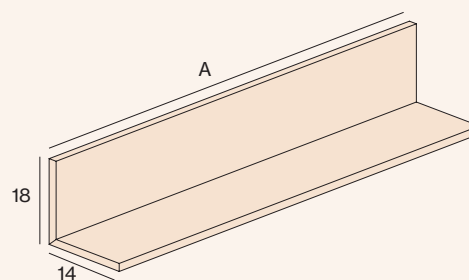

PRATELEIRA BOX



| A (cm) | REF     | MADEIRA NATURE | LACA | PRANCHA MADEIRA MARINHA | MADEIRA SÓLIDO |
|--------|---------|----------------|------|-------------------------|----------------|
|        |         | PVP            | PVP  | PVP                     | PVP            |
| 30     | XEB.030 | -              | -    | -                       | -              |
| 40     | XEB.040 | -              | -    | -                       | -              |
| 60     | XEB.060 | -              | -    | -                       | -              |
| 70     | XEB.070 | -              | -    | -                       | -              |
| 80     | XEB.080 | -              | -    | -                       | -              |
| 90     | XEB.090 | -              | -    | -                       | -              |
| 100    | XEB.100 | -              | -    | -                       | -              |
| 120    | XEB.120 | -              | -    | -                       | -              |
| 140    | XEB.140 | -              | -    | -                       | -              |

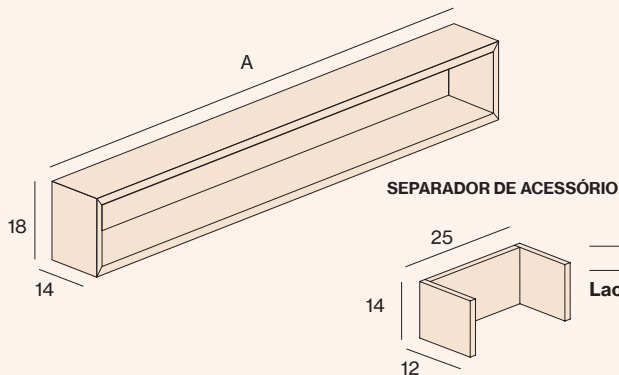

PRATELEIRA METÁLICA DUPLA



| A (cm)                          | REF       | MADEIRA NATURE | LACA | PRANCHA MADEIRA MARINHA | MADEIRA SÓLIDO | CRISTAL FUMÉ |
|---------------------------------|-----------|----------------|------|-------------------------|----------------|--------------|
|                                 |           | PVP            | PVP  | PVP                     | PVP            | PVP          |
| <b>ESTRUTURA METÁLICA PRETO</b> |           |                |      |                         |                |              |
| 30                              | XEM.030.N | -              | -    | -                       | -              | -            |
| 40                              | XEM.040.N | -              | -    | -                       | -              | -            |
| 60                              | XEM.060.N | -              | -    | -                       | -              | -            |
| 70                              | XEM.070.N | -              | -    | -                       | -              | -            |
| 80                              | XEM.080.N | -              | -    | -                       | -              | -            |
| 90                              | XEM.090.N | -              | -    | -                       | -              | -            |
| 100                             | XEM.100.N | -              | -    | -                       | -              | -            |
| 120                             | XEM.120.N | -              | -    | -                       | -              | -            |
| 140                             | XEM.140.N | -              | -    | -                       | -              | -            |

ESTRUTURA METÁLICA DE CORES (TABELA LACADA)

|     |           |   |   |   |   |   |
|-----|-----------|---|---|---|---|---|
| 30  | XEM.030.C | - | - | - | - | - |
| 40  | XEM.040.C | - | - | - | - | - |
| 60  | XEM.060.C | - | - | - | - | - |
| 70  | XEM.070.C | - | - | - | - | - |
| 80  | XEM.080.C | - | - | - | - | - |
| 90  | XEM.090.C | - | - | - | - | - |
| 100 | XEM.100.C | - | - | - | - | - |
| 120 | XEM.120.C | - | - | - | - | - |
| 140 | XEM.140.C | - | - | - | - | - |

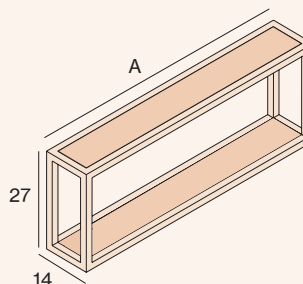

PRATELEIRA METÁLICA COM TOALHEIRO

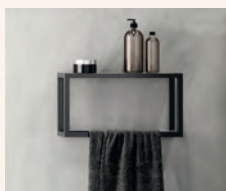

| A (cm)                          | REF       | MADEIRA NATURE | LACA | PRANCHA MADEIRA MARINHA | MADEIRA SÓLIDO | CRISTAL EU FUMEI |
|---------------------------------|-----------|----------------|------|-------------------------|----------------|------------------|
|                                 |           | PVP            | PVP  | PVP                     | PVP            | PVP              |
| <b>ESTRUTURA METÁLICA PRETO</b> |           |                |      |                         |                |                  |
| 30                              | XET.030.N | -              | -    | -                       | -              | -                |
| 40                              | XET.040.N | -              | -    | -                       | -              | -                |
| 60                              | XET.060.N | -              | -    | -                       | -              | -                |
| 70                              | XET.070.N | -              | -    | -                       | -              | -                |
| 80                              | XET.080.N | -              | -    | -                       | -              | -                |
| 90                              | XET.090.N | -              | -    | -                       | -              | -                |
| 100                             | XET.100.N | -              | -    | -                       | -              | -                |
| 120                             | XET.120.N | -              | -    | -                       | -              | -                |
| 140                             | XET.140.N | -              | -    | -                       | -              | -                |

ESTRUTURA METÁLICA DE CORES (TABELA LACADA)

|     |           |   |   |   |   |   |
|-----|-----------|---|---|---|---|---|
| 30  | XET.030.C | - | - | - | - | - |
| 40  | XET.040.C | - | - | - | - | - |
| 60  | XET.060.C | - | - | - | - | - |
| 70  | XET.070.C | - | - | - | - | - |
| 80  | XET.080.C | - | - | - | - | - |
| 90  | XET.090.C | - | - | - | - | - |
| 100 | XET.100.C | - | - | - | - | - |
| 120 | XET.120.C | - | - | - | - | - |
| 140 | XET.140.C | - | - | - | - | - |

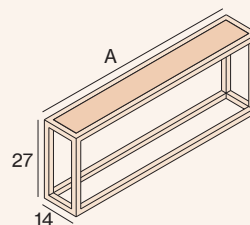

RACK DE TOALHA DE PAREDE

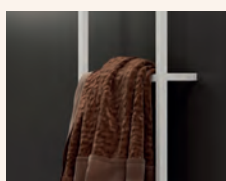

| REF  | PVP |
|--|-----|
| <b>ESTRUTURA METÁLICA PRETO</b>                    |     |
| XTP:160.N  | -   |
| <b>ESTRUTURA METÁLICA DE CORES (TABELA LACADA)</b> |     |
| XTP:160.C  | -   |

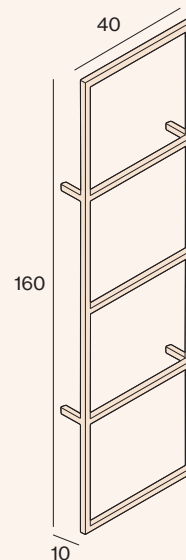

RACK PARA TOALHAS DE PÉ INDEPENDENTE

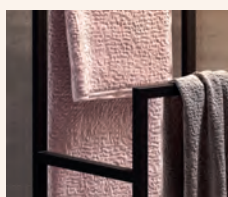

| REF  | PVP |
|--|-----|
| <b>ESTRUTURA METÁLICA PRETO</b>                    |     |
| XTI.090.N  | -   |
| <b>ESTRUTURA METÁLICA DE CORES (TABELA LACADA)</b> |     |
| XTI.090.C  | -   |

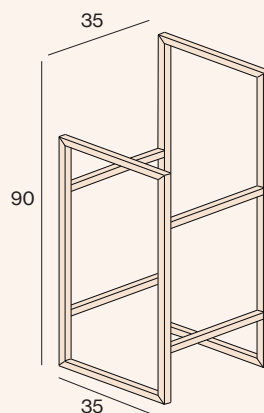

CALÇADA



| A (cm)   | REF       | MADEIRA NATURE | LACA | PRANCHA MADEIRA MARINHA | MADEIRA SÓLIDO |
|--|-----------|----------------|------|-------------------------|----------------|
|  |           | PVP            | PVP  | PVP                     | PVP            |
| <b>ESTRUTURA METÁLICA PRETO</b>                    |           |                |      |                         |                |
| 35   | XTU.035.N | -              | -    | -                       | -              |
| 60   | XTU.060.N | -              | -    | -                       | -              |
| <b>ESTRUTURA METÁLICA DE CORES (TABELA LACADA)</b> |           |                |      |                         |                |
| 35   | XTU.035.C | -              | -    | -                       | -              |
| 60   | XTU.060.C | -              | -    | -                       | -              |

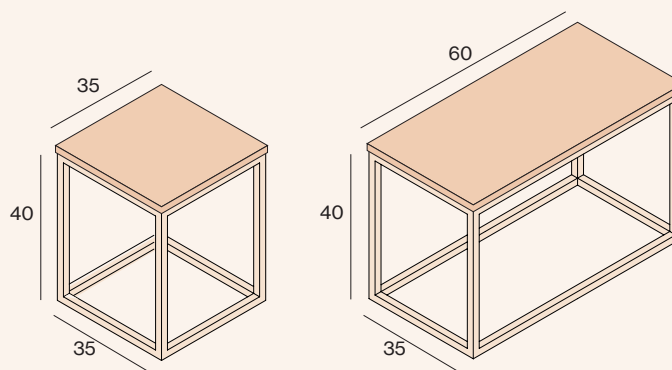

### MÓDULO DE COLUMNA

By **CÍRCULO CUADRADO**



| A (cm) | H (cm) | REF       | LACA       |
|--------|--------|-----------|------------|
|        |        |           | <b>PVP</b> |
| 30     | 60     | XMD.3060  | -          |
| 15     | 60     | XMD.1560  | -          |
| 30     | 90     | XMD.3090  | -          |
| 15     | 90     | XMD.1590  | -          |
| 30     | 180    | XMD.30180 | -          |
| 15     | 180    | XMD.15180 | -          |

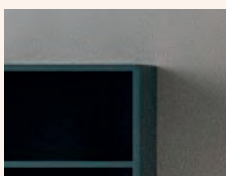
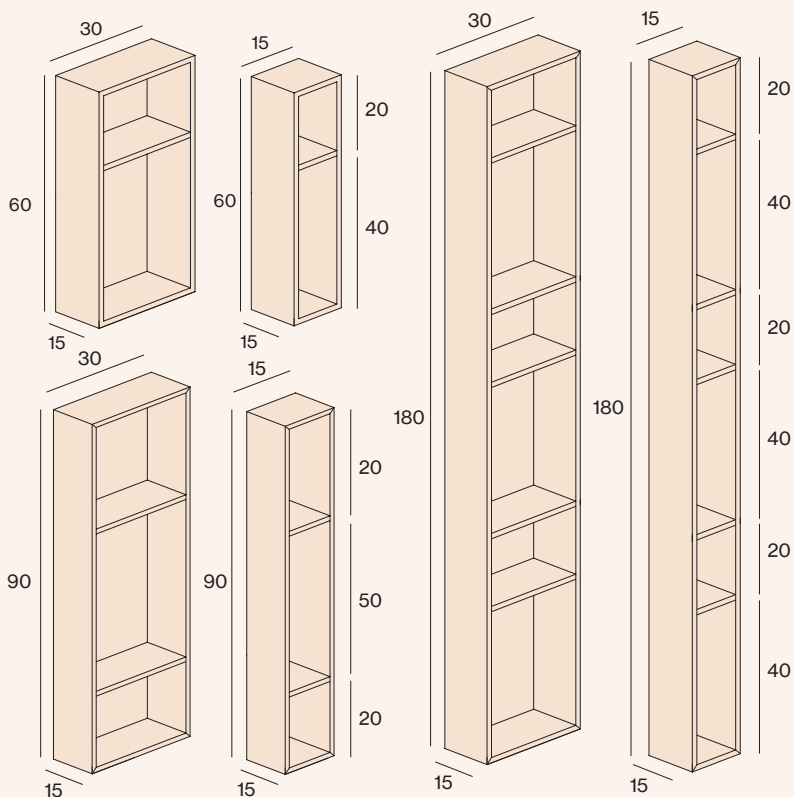

- Espessura 13 mm
- Sistema de suspensão oculto
- Instalação de 2 posições





### SET DE PENTEADEIRAS

By **CÍRCULO CUADRADO**



- Espessura 13 mm
- Sistema de suspensão oculto
- Espelho opcional

| A (cm) | SIM ESPELHO |     | COM ESPELHO |     |
|--------|-------------|-----|-------------|-----|
|        | REF         | PVP | REF         | PVP |
| 60     | XMB.60      | -   | XMS.60      | -   |
| 90     | XMB.90      | -   | XMS.90      | -   |

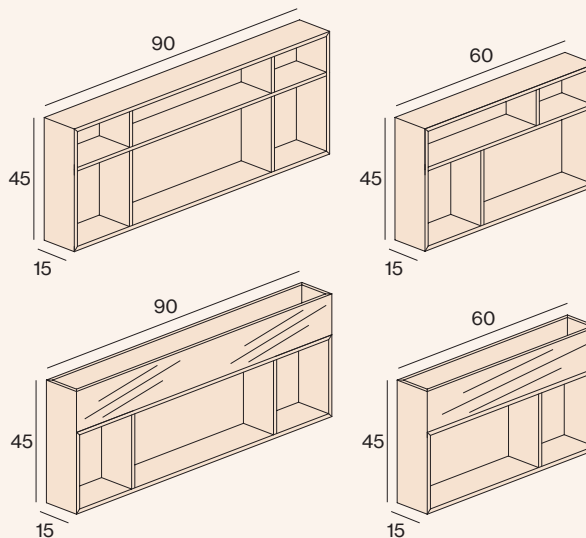

### TOALHEIRO LEAN

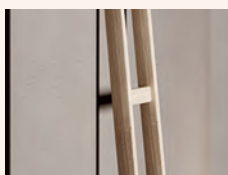

- Em carvalho maciço de espessura 20 mm

### REF MADEIRA MACIÇA

| REF | PVP |
|-----|-----|
| XML | -   |

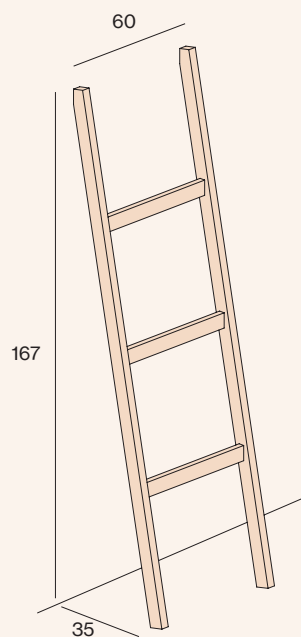

Novo catálogo de BANHEIRAS 2023

DECOSAN

consultá-lo em [www.decosan.com](http://www.decosan.com)

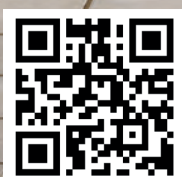
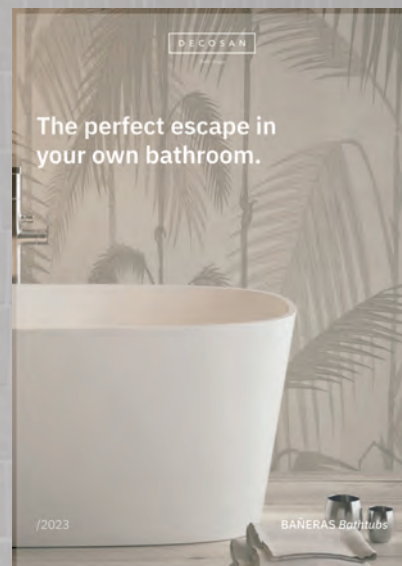



Catálogo exclusivo COLEÇÕES DE CASA DE BANHO

DECOSAN

consultá-lo em [www.decosan.com](http://www.decosan.com)







# 07

# Cores

Cores e acabamentos que transmitem emoções.

**Blanco Mate**

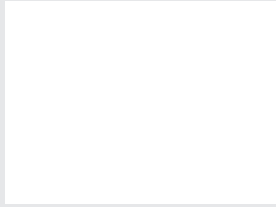

**Negro Mate**

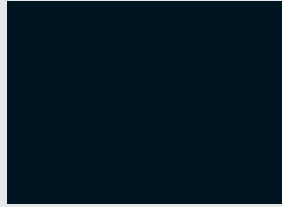

**Beige Mate**

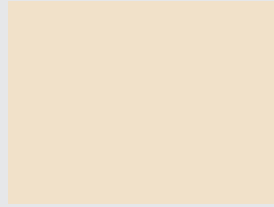

**Tierra Mate**



**Caqui Mate**

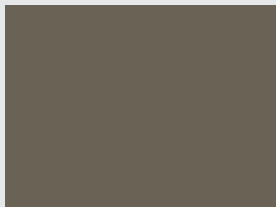

**Cuarzo Mate**



**Moka Mate**

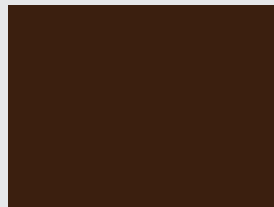

**Perla Mate**

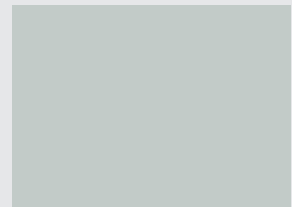

**Piedra Mate**



**Acero Mate**



**Antracita Mate**



**Burdeos Mate**



**Océano Mate**



**Menta Mate**

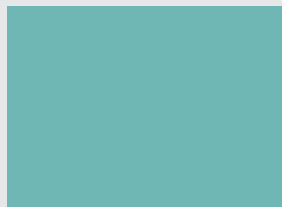

**Oliva Mate**

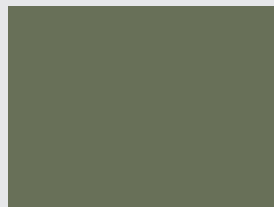

**Terracota Mate**

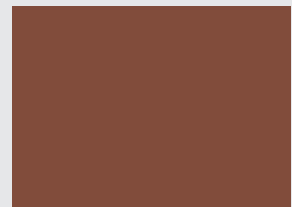

**Albero Mate**



**Rosa Mate**

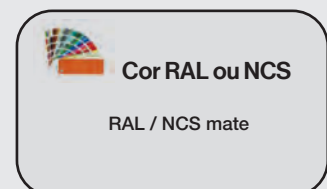
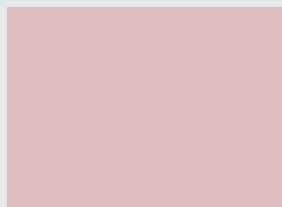

**Blanco Brilho**

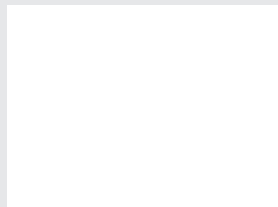

**Negro Brilho**

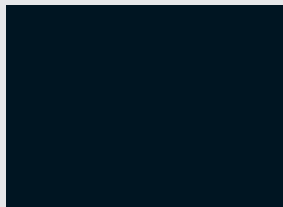

**Beige Brilho**

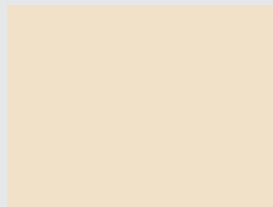

**Tierra Brilho**



**Caqui Brilho**

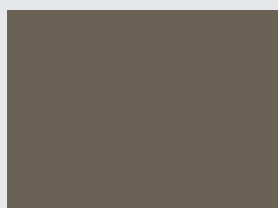

**Cuarzo Brilho**



**Moka Brilho**

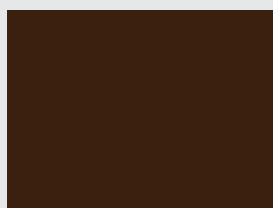

**Perla Brilho**

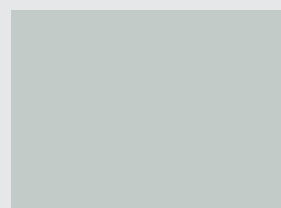

**Piedra Brilho**

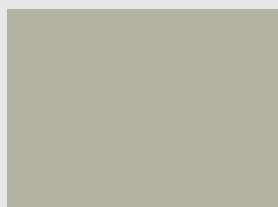

**Acero Brilho**



**Antracita Brilho**



**Burdeos Brilho**



**Océano Brilho**



**Menta Brilho**

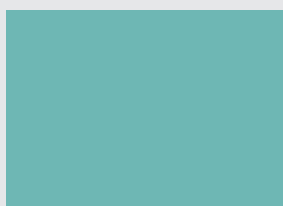

**Oliva Brilho**



**Terracota Brilho**

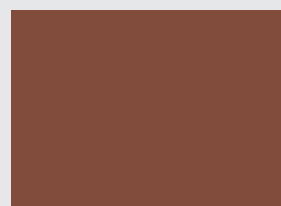

**Albero Brilho**



**Rosa Brilho**

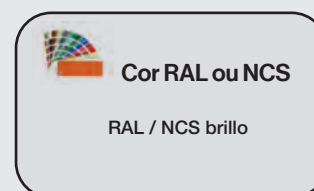
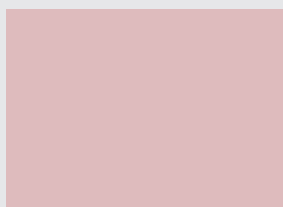

**Carbon**



**Brown**



**Artic**



**Cocoa**



**Camel**

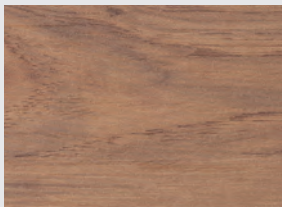

**Savana**



**Nogueira**

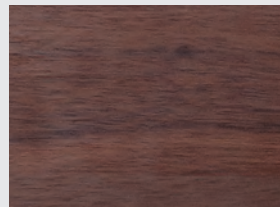

Prancha Madeira Marinha

**Ash**

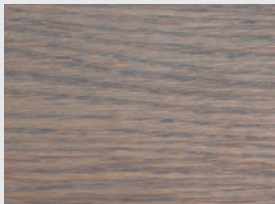

**Charcoal**

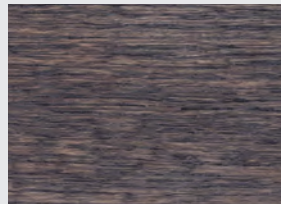

**Antique**

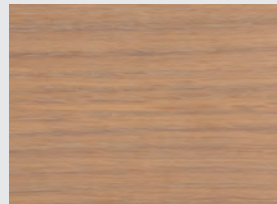

**Aceitado**

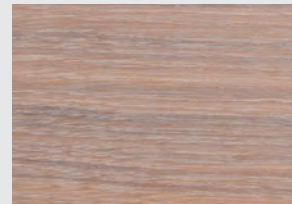

**Cherry**

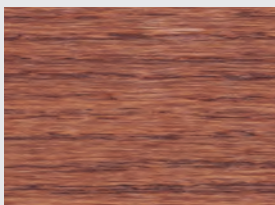

**Bourbon**



**Legno Rústico**

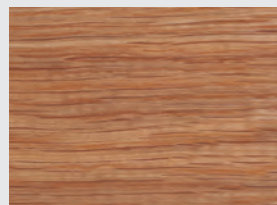

**Nogueira**

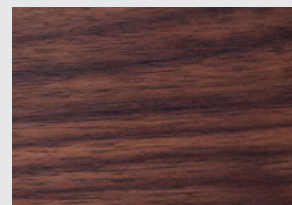



**Ash**



**Charcoal**

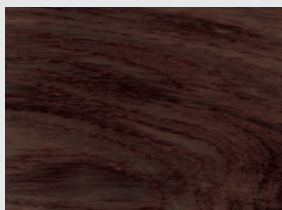

**Antique**

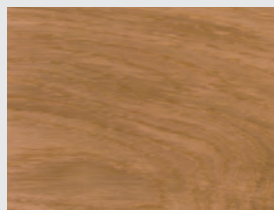

**Aceitado**

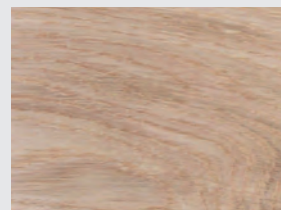

**Cherry**

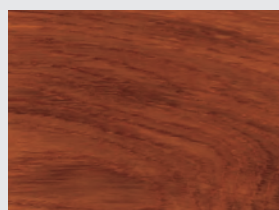

**Bourbon**

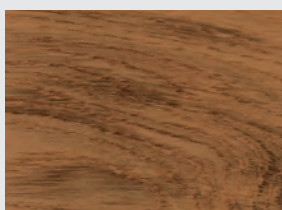

**Legno**



Ceramcolor

**Blanco**

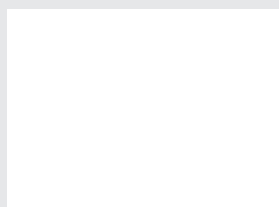

**Negro**

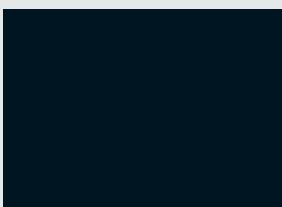

**Tierra**



**Cuarzo**

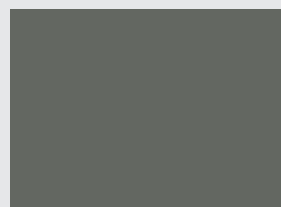

**Acero**

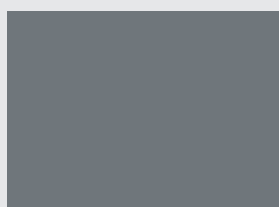

**Antracita**



**Oliva**



**Blanco**

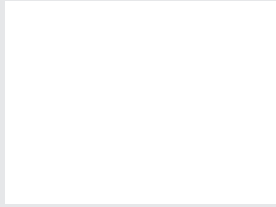

**Negro**

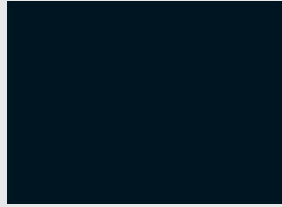

**Beige**

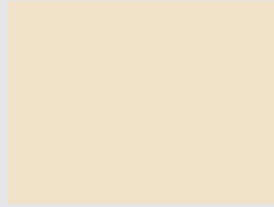

**Tierra**



**Caqui**

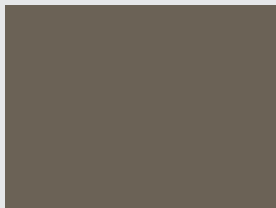

**Cuarzo**



**Moka**



**Perla**

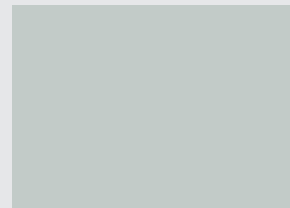

**Piedra**



**Acero**



**Antracita**



**Burdeos**



**Océano**



**Menta**

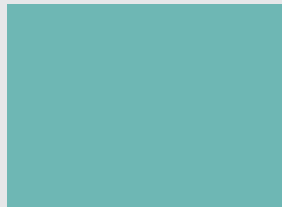

**Oliva**



**Terracota**

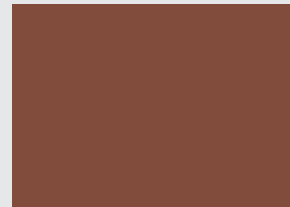

**Albero**



**Rosa**

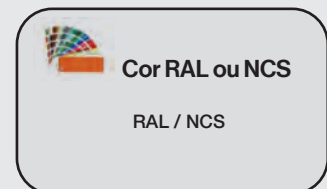
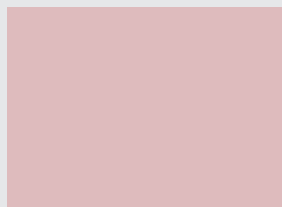

**Negro Compacto**



**Negro Marquina**

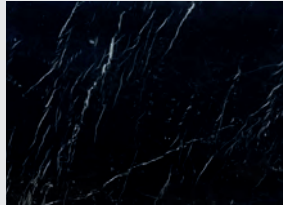

**Pietra Gris**



**Verde India**

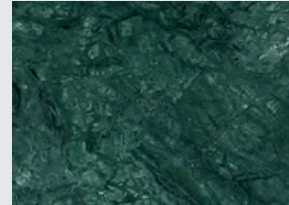

**Crema Marfil**



**Carrara**



Metal

**Oro Cepillado**

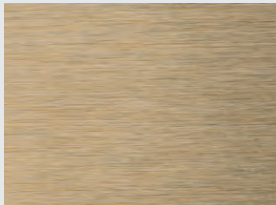

**Cobre Cepillado**



**Acero Cepillado**

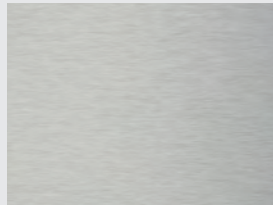

# Termos de venda

As seguintes condições são válidas para a venda de produtos de Artesania Baño, SL-DECOSAN. A emissão de encomendas pela empresa compradora implica a aceitação das presentes condições de venda. Qualquer modificação destas condições estará sujeita à aprovação por escrito de Artesania Baño, SL-DECOSAGRADO.

## Preços

Os preços não incluem IVA ou outros impostos. Os preços do catálogo podem ser alterados sem aviso prévio e são válidos com base na tarifa em vigor no dia do envio.

## Impostos

Cobrar na fatura conforme legislação em vigor. Os compromissos de pagamento devem ser efectuados à vista de acordo com as condições de crédito acordadas e de acordo com o disposto na Lei 16/2009 de 13 de Novembro, relativa aos serviços de pagamento.

## Termos de pagamento

Até que a classificação e o risco adequados sejam concedidos, todas as transações serão feitas com base no pré-pagamento.

## Operações subsequentes

O diferimento do pagamento das nossas faturas será acordado entre as duas partes. Uma vez expirados os prazos acordados, estamos automaticamente autorizados a contabilizar juros de mora à taxa de UM POR CEN-TO por mês ou fração.

As parcelas pendentes de faturamento sempre expiram imediatamente quando o comprador é declarado insolvente, se o processo de insolvência ou falência for iniciado, se sua empresa for vendida ou se houver mudança de titularidade.

Em caso de incumprimento das condições de pagamento e / ou devolução dos efeitos negociados, Artesania Baño, SL-DECOSAN reembolsará integralmente os custos de devolução e administração, considerando as condições acordadas com o cliente canceladas (por incumprimento) e renunciar aos efeitos pendentes.

## Reserva de domínio

A mercadoria é considerada propriedade de Artesania Baño, SL / DECOSAN até o pagamento integral da mesma pelo cliente, com o domínio reservado ArtesaniaBaño, SL / DECOSAN até esse momento.

## Jurisdição

Esta relação será regida pela lei espanhola. Em caso de litígio, as partes renunciam expressamente a qualquer outro foro ou jurisdição a que tenham direito e concordam em submeter-se aos Tribunais de Barcelona.

## Pedidos

Todos os pedidos devem ser formalizados por documento escrito. Essencial para processamento especial:

- Anexe um esboço com as medidas do produto solicitado.
- Pago 50% do valor total na aceitação da encomenda. O resto do pago segue as condições acordadas.
- Os preços não incluem instalação ou suposta operação.

## Garantia

Certificamos que todos os produtos têm garantia de dois anos devido a defeitos de fabrico em condições normais de utilização e instalação, de acordo com o Real Decreto Legislativo 1/2007 de 16 de Novembro, a empresa que se compromete a reparar ou substituir os materiais cujas anomalias se devam essas causas.

O direito à indenização está excluído (qualquer que seja o ato jurídico fundamental aceite), a menos que seja comprovado de forma confiável que respondemos com dolo ou negligência grave. A garantia não cobre defeitos causados por uso indevido, instalação defeituosa ou inadequada ou defeitos causados por causas de força maior.

## Projeto

Artesania Baño, SL-DECOSAN reserva-se o direito de fazer modificações nos artigos, sem prévio aviso, em qualquer área das características técnicas, estéticas ou de avaliação.

## Termos de entrega

O tempo de entrega aproximado é de 3 semanas para itens de catálogo padrão e 4 semanas para aqueles que estão sujeitos a quaisquer alterações que serão especiais, a menos que outro tempo de entrega seja especificado por motivos de produção ou planeamento.

Quaisquer atrasos nos prazos de entrega acordados não implicam o direito a indemnização por danos ou outras causas.

## Transporte de carga

- Quando a mercadoria, transita correctamente, Artesania Baño, S.L. / DECOSAN está isenta de quaisquer vícios ou defeitos que possam ser imputáveis ao transporte de mercadoria.

Quando a mercadoria viaja em modo pré-pago, o cliente deve notificar a Artesania Baño, S.L. / DECOSAN por escrito no prazo de 24 horas após o recepção da mercadoria, qualquer defeito ou defeito imputável à agência de transporte para facilitar a reclamação de responsabilidade nos termos da lei 16/1987 sobre o Regulamento de Transporte Terrestre e RD 1111/1990 que aprova os regulamentos de LOTT.

- A reclamação contra a transportadora por danos ou falhas deve ser apresentada na escritura de recebimento das parcelas, desde que o dano seja evidente e no prazo de 24 horas após o recebimento, se o dano não for evidente, a reclamação ou reserva deve ser feita em escrevendo.

- As mercadorias viajam sempre por conta e risco do comprador, mesmo no caso de acordos especiais.

- Transporte pago:

Península a partir de € 250. às

Baleares a partir de € 500.

para as Ilhas Canárias a partir de 1.500 euros.

em Ceuta e Melilha consultar os portes de envio.

O preço do envio é de 15 €. Em caso de envio único de bancadas, espelhos ou lavatórios que requeiram embalagens especiais, o valor mínimo será de 30 € líquidos.

## Reembolso

Serão aceites devoluções única e exclusivamente para mercadorias defeituosas e / ou incorretamente enviadas por Artesania Baño, SL / DECOSAN. Qualquer devolução deve ser sempre comunicada por escrito e autorizada por Artesania Baño, SL / DECOSAN

A devolução da mercadoria deverá ser efectuada na embalagem original e em perfeitas condições e sofrerá uma depreciação automática de pelo menos 15% sobre o valor faturado pelos custos de gestão e armazenamento, que poderá ser superior após o controlo.

## Integridade

É obrigação do destinatário verificar a embalagem e o produto no ato do recebimento. Em caso de observação de algum incidente no momento da entrega, anote o incidente na guia de remessa e envie uma comunicação escrita a Artesania Baño, SL / DECOSAN acompanhada de algumas fotografias.

Caso não seja detectado nenhum defeito visível à chegada, anote na guia de remessa "conforme com o exame" e efetue esta verificação no prazo máximo de 24 horas, procedendo se for caso disso ao envio da reclamação com as mesmas condições escritas e com imagens que permitam avaliar o que aconteceu. Em caso de inobservância dos procedimentos relativos, a empresa não aceitará qualquer reclamação a este respeito visto que a cobertura de transporte declina qualquer responsabilidade nos termos da Lei 16/1987 de Gestão dos Transportes Terrestres e RD 1111 / 1990 com a qual os regulamentos são aprovados. MUITO.

## Confidencialidade e proteção de dados

Em conformidade com o disposto na Lei Orgânica 15/1999 de 13 de dezembro sobre a Proteção de Dados Pessoais e do REGULAMENTO (UE) 2016/679 DO PARLAMENTO EUROPEU E DO CONSELHO de 27 de abril de 2016 (GDPR), os dados pessoais as prestações do comprador farão parte da prática do vendedor, cujos objetivos são a manutenção da relação contratual, a gestão das vendas e das cobranças. O vendedor tratará estes dados com a máxima confidencialidade e compromete-se a não os utilizar para fim diferente daquele para que foram recolhidos, bem como a serem guardados com medidas que garantam a sua segurança a terceiros não autorizados. O comprador tem direito de acesso, retificação e cancelamento mediante o envio de uma comunicação escrita a Artesania Baño, SL / DECOSAN Ctra.

## Dimensões recomendadas para instalação sanitária

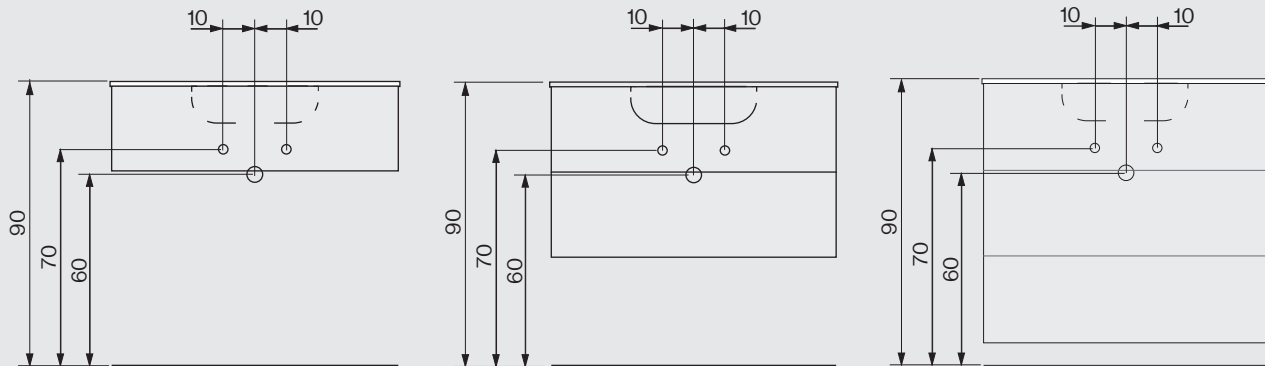

Móveis desta altura não suportam o sistema DecoSpace

## Decospace System

**Com bancada integrado**

**Com lavatório de bancada**

**Com registro sanitário**

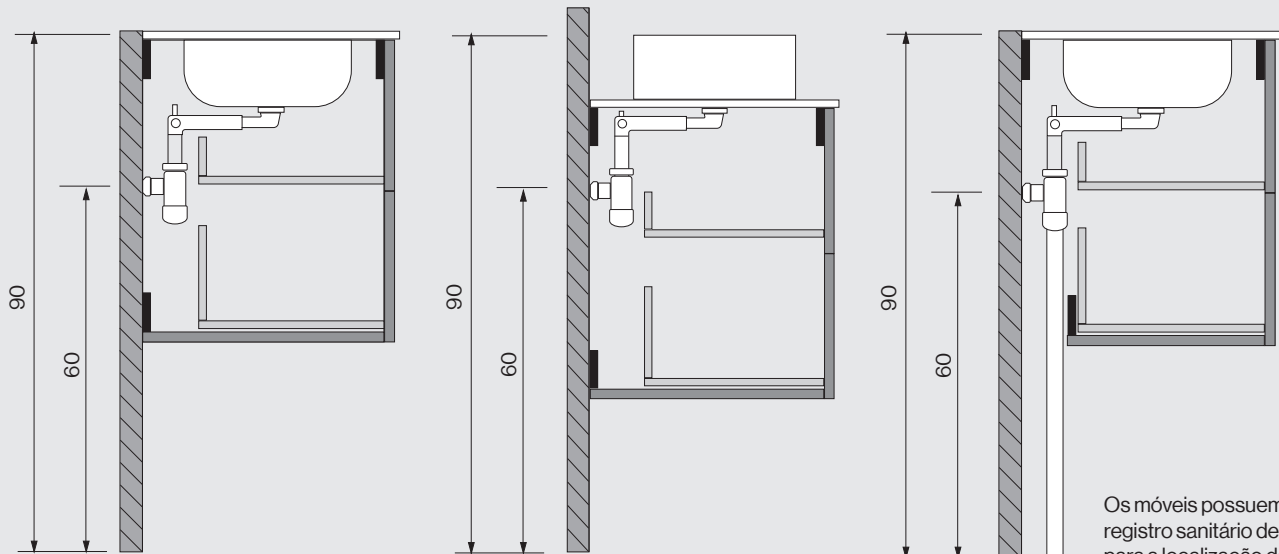

Os móveis possuem o registro sanitário desejado para a localização da parede ou do piso.

Todos os itens são fornecidos com uma chave de fenda e os acessórios necessários para o seu posicionamento, além de um manual montagem para seu correto comissionamento.

DECOSAN

Bath design



# DECOSAN

## DECOSAN CENTRAL

Ctra. Laureà Miró, 385-387  
08980 Sant Feliu de Llobregat  
Barcelona – España  
tels. +34 933 378 616, +34 933 378 187  
decosan@decosan.com  
www.decosan.com

## DECOSAN BARCELONA

Showroom Contract. Rambla Catalunya, 43  
Principal, 1ª - 08007 Barcelona - España  
+34 640 04 47 45  
info@wecontractbcn.com

## DECOSAN MILANO

Via Torino, 10 – 20060 Liscate  
Milano – Italia  
+39 0249796141  
cmarconi-bocchi@nofer.com

## DECOSAN MOSCÚ

107113, Moscow - Shumkina str. 26a str.4 Russian  
Federation  
+7 (495) 602-05-85  
info@nofer-aporici.ru

## DECOSAN DUBAI

Office # 1, Industrial Area 18, Maliha Road, P.O. Box  
4316, Sharjah, UAE  
+971 65467420  
info@mena-gate.com



NOFER



DECOSAN

BOCCHI SafeWORK

agetar, s.a.

